

Pilot's Guide to **FOREFLIGHT MOBILE**



ForeFlight
Intelligent Apps for Pilots™

75th Edition
Covers ForeFlight Mobile v12.0

Introduction.....	22
iPad Tips.....	22
Setting-up ForeFlight Mobile	24
Search in ForeFlight Mobile	26
Planning a Flight	27
Planning a flight using the Flights form.....	27
Destination Services.....	28
Navlog, Briefing, Messages.....	30
Planning a flight on Maps using the Flight Plan Editor	32
Planning a flight on Maps using Touch.....	33
Planning a flight using Search.....	36
Search for N-number or Scheduled Flight.....	38
3D Review.....	39
Airports.....	41
About the Design	42
Finding an Airport using Search	42
Favorites/Recents/Browse	43
Finding an Airport Using Browse	43
Favorite Airports List.....	43
Recent Airports List.....	45
Favorite and Recent Airport Sync.....	45
Airport 3D View	46

Viewing Airport Frequencies.....	48
Viewing Airport Weather.....	49
Digital ATIS (D-ATIS).....	50
Model Output Statistics (MOS) Forecasts.....	51
Runway Winds.....	53
Viewing a Procedure.....	54
Swipe to Change Plates.....	55
Using Geo-Referenced Procedures.....	57
Airport NOTAMs.....	58
FBO Information.....	59
Comments.....	60
Fuel prices.....	60
Airport/Facility Directory (A/FD), Canada Flight Supplement (CFS), or Aeronautical Information Publication (AIP).....	61
Airport and Aircraft Flight Tracking.....	62
Maps.....	63
About the Design.....	63
High Resolution Basemap.....	64
Pinch, Zoom, and Pan.....	65
Map Annotations.....	65
Changing Maps / Map Layers.....	67
Weather Layer Time Slider.....	77

Map Info pop-up for Overlapping Map Layers.....	78
3D View Anywhere.....	79
Global Aeronautical Map.....	80
Aeronautical Map Features.....	81
Airspace Label Style	83
Aeronautical Map Filters.....	84
Aeronautical Map Symbols.....	85
European Airspace	88
Automatic Airspace Highlighting.....	89
Hide Airspace by Altitude.....	90
Organized Track Systems.....	91
Global Airspace Details.....	92
Maps Settings	93
Map Touch	97
Smart Airway Labels	99
Airport popup	100
Weather Layer Color Coding.....	102
Attitude Indicator / Synthetic Vision	105
iPhone Attitude Indicator/Synthetic Vision (AI/SV).....	107
IMPORTANT NOTICE: ATTITUDE INDICATOR DISPLAY	108
Glance Mode	110
Portable AHRS Positioning.....	111
Calibrate the AI/SV display.....	111

Synthetic Vision required downloads.....	112
Finding an Airport, Navigation Aid, or Aircraft using Search.....	113
Airspace Information.....	115
Route Line	115
Working with the NavLog, Edit and Profile Views.....	116
Overview.....	116
Flight Plan Editor.....	117
Procedure Advisor.....	120
Reverse	128
Route Advisor.....	129
Route Advisor - Eurocontrol Valid and Invalid Routes	131
Route Editor	132
NavLog View.....	136
Profile View	137
Show altitude by “scrubbing”.....	142
Single-waypoint Search.....	145
Engaging the Moving Map.....	146
Track Up	146
Distance Rings	147
Glide Advisor™	149
Track Vector	151
Direct-To.....	152
Ruler	152

Viewing and Hiding the Instrument Panel	153
Using Favorite and Recent Routes.....	155
Favorite and Recent Route Sync	156
Clearing a Route.....	156
Alerts.....	157
About The Design.....	157
Runway Proximity Advisor	157
Cabin Altitude Advisor.....	158
Terrain/Obstacle Alerts.....	158
Traffic Alerts.....	159
TFR Alerts	159
Sink Rate.....	161
Runway Final Approach.....	162
500' AGL	163
Device Disconnect.....	163
Destination Weather Frequency	164
Transition Altitude.....	165
New Flight Plan Loaded From Panel	165
Low Battery.....	165
Pack.....	166
About the Design.....	166

Pack for a Flight.....	168
Sync.....	170
About the Design.....	170
Using Sync.....	170
Cockpit Sharing	173
About the Design.....	173
Using Cockpit Sharing.....	173
Plates.....	174
About the Design.....	174
About Plate Binders	175
Creating a Binder	175
Managing Plates.....	175
Plate Controls.....	177
NOTAM Advisor for Approach Plates and Airport Diagrams.....	178
FBOs on Airport Diagrams.....	179
Printing Plates From a Binder.....	180
Ensuring Your Plates Don't Expire	180
Plates and Taxi Diagrams on a Map.....	181
About the Design.....	181
Displaying a Plate on a Map.....	182
Changing or Hiding the Plate on a Map.....	183

Adjusting Plate Transparency	183
Track Logs	184
About the Design.....	184
Enabling Track Logging.....	184
Start/Stop Logging.....	184
Flight Time Instrument.....	185
Track Log Listing	185
Graphical Track Log view.....	186
Control Buttons	187
Synchronizing Track Logs to other Devices.....	189
Viewing a Track Log on ForeFlight on the web.....	189
Sharing Track Logs	189
Exporting Track Logs to other Apps	190
Importing G1000 Track Logs	191
Viewing Track Logs in ForeFlight on the web.....	193
Breadcrumbs	194
About the design.....	194
Documents	195
About the Design.....	195
Drives and Binders.....	196
Downloading and Opening a Document.....	198

Automatic Document Updates	199
Creating and Managing Binders	199
Deleting a Document.....	200
Cloud Document Syncing.....	201
Automatic Downloads / Download All.....	202
Unlinked Cloud Drive: <Missing Drive>	203
Importing Documents from iTunes or other Apps.....	204
Viewing a Document.....	206
Searching for a Document	207
Searching in a Document	208
Adding and Removing Bookmarks.....	208
Ensuring Your Documents Don't Expire.....	208
Annotating Plates and PDF Documents	209
About the Design.....	209
Types of Annotations	210
Adding and Editing Annotations	211
iPad	211
iPhone.....	211
Choosing Annotation Color.....	211
Fill Color: Transparent or "No Fill"	213
Drawing/Ink.....	213
Text Box.....	213
Rectangle.....	215

Ellipse (Circle).....	215
Line	215
Polygon	216
Polyline.....	217
Sticky-note	217
Undo/Redo.....	217
Selecting Multiple Annotations.....	218
Copying and Pasting an Annotation	218
Deleting Annotations.....	218
Imagery	219
About the Design.....	219
Selecting a Collection.....	220
NATIONAL - Featured.....	220
CONUS WEATHER.....	221
GRAPHICAL AVIATION FORECASTS.....	225
ADVISORIES.....	226
WINDS ALOFT.....	227
ICING	227
TURBULENCE.....	230
SATELLITE.....	231
DOPPLER RADAR.....	232
PILOT WEATHER REPORTS.....	232
CEILING AND VISIBILITY ANALYSIS.....	233
Viewing an Image.....	234

Using Favorite Images	234
Send To.....	234
Flights.....	235
About the Design.....	235
Takeoff and Landing Performance.....	236
Alternate Advisor.....	237
Adding Files to a Flight.....	238
Sharing a Flight	239
Before Filing a Flight Plan.....	241
Choosing between ICAO and FAA/Domestic Flight Plans.....	242
Creating a Flight Plan.....	242
Creating an ICAO Flight Plan.....	243
Exporting an ICAO Flight Plan as PDF.....	243
Obtaining a Weather Briefing.....	243
Filing your Flight Plan	244
Filling a VFR flight plan in Canada.....	245
Filing an IFR, Y, or Z Flight Plan in Europe (ICAO ONLY).....	246
Flight Plan Acknowledgment Notification.....	246
Flight Notifications.....	247
Amending or Canceling a Flight Plan.....	249
In the USA.....	249
In Canada.....	249

Amending a Filed Flight Plan.....	250
Activating or Closing a VFR Flight Plan.....	252
Important note for Canadian VFR Flight Plans.....	252
Close VFR Flight Plan “PUSH” Alerts.....	254
Managing Flight Plans	254
Flight Alerts - Expected Routes.....	254
Flight Log.....	257
ForeFlight Briefing	258
About the Design.....	258
Navigating the Briefing.....	259
Translated Text vs Raw Text.....	259
Briefing Sections	260
Adverse Conditions.....	260
Synopsis	261
Current Weather.....	261
Forecasts.....	261
NOTAMs	263
Miscellaneous.....	263
ScratchPads	264
About the Design.....	264
ScratchPad Templates	265
Change Pen Size, Color, Opacity	265

Undo/Redo/Eraser.....	266
Clear ScratchPad Content.....	266
Edit a ScratchPad Name	266
Reposition ScratchPad Thumbnails.....	267
Send a ScratchPad.....	267
Delete a ScratchPad.....	267
More	268
Downloads	268
About the Design.....	268
Grouped Downloads.....	271
Select Data to Download.....	271
Downloading Data.....	273
Downloading in the Background.....	273
Keeping Current.....	274
Deleting Data Downloads	274
A Quick Tour of the Data Available for Download.....	275
Preflight Download Check.....	276
Troubleshooting Downloads.....	276
Checklist.....	278
Setting Up Checklists	279
Editing Checklists.....	280
Using Checklists.....	281
Speaking Checklist.....	281

Tapping Checklist.....	281
Sharing Checklists.....	282
Logbook.....	284
Weight & Balance.....	285
Aircraft	286
Create or Edit an Aircraft.....	286
Basic Performance Profile.....	288
Sharing an Aircraft with another account	289
Delete Aircraft.....	290
Manage Aircraft for Multi-Pilot Accounts.....	291
Custom Content.....	293
Importing Custom Content files.....	293
Deleting Custom Content.....	295
Sharing User Waypoints.....	296
Creating User Waypoints	296
Latitude/Longitude Formats	297
Custom Map Layers.....	299
Custom Charts	300
Content Packs	301
Content Pack Structure	302
Importing a Content Pack.....	304
Track Logs.....	305
Passenger	305
Troubleshooting Passenger.....	306

Devices	307
Location Disabled / Troubleshooting GPS position issues.....	307
Account	309
About the Design.....	309
Viewing your Active Subscription	309
Purchasing or Renewing a ForeFlight Subscription.....	310
Signing In to your ForeFlight Account.....	313
Signing Out of your ForeFlight Account	313
Changing your Password or Email.....	313
Removing Devices from your Account.....	314
Jeppesen.....	315
Purchasing Through ForeFlight (single-pilot accounts only).....	315
Linking an Existing Jeppesen Account in ForeFlight Mobile.....	317
Linking an Existing Jeppesen Account in ForeFlight on the Web	318
Using Jeppesen Terminal Charts in ForeFlight.....	319
Using Jeppesen Enroute Charts in ForeFlight.....	320
Settings.....	323
About	331
ADS-B Weather.....	332
Overview.....	332
ADS-B Weather Products	332
ADS-B Information.....	333
Animated ADS-B Radar	334

ADS-B Tower Location on Map.....	335
ADS-B Traffic	336
Overview	336
IMPORTANT TRAFFIC NOTICE.....	336
Traffic Access in ForeFlight Mobile.....	336
Status Information.....	337
Traffic Symbols	338
Hide Distant Traffic Setting	339
Traffic in Synthetic Vision.....	340
Ownship ADS-B Out Information.....	340
Traffic Alerts	341
ForeFlight Connect.....	342
Overview	342
Sentry ADS-B Receiver, with GPS, ARHS, and CO Sensor	342
Connecting to Sentry	343
Sentry AHRS Setup.....	343
Using Sentry	343
Carbon Monoxide (CO) Monitor.....	345
Updating Sentry's Firmware	345
Scout ADS-B Receiver.....	346
Connecting to Scout.....	346
Using Scout.....	346

ADS-B From Scout.....	347
Updating Scout’s Firmware	347
Stratus ADS-B Receivers	348
Stratus Status Information	348
Stratus ESG (Stratus 1S/2/2S/3 Only).....	351
Stratus Replay (Stratus 1S/2/2S/3/3 Only).....	352
Stratus Flight Data Recorder.....	352
Recording a Track Log Using the Flight Data Recorder	352
Stratus Firmware Update.....	354
Garmin Connex.....	356
Pairing with Flight Stream.....	356
Using Connex	356
GPS and ADS-B from Connex.....	358
Sending a Route to Connex (requires Flight Stream 210 or 510).....	359
Getting a Route from Connex (requires Flight Stream 210 or 510)	360
Calibrating Flight Stream 210 AHRS	361
Garmin GTX 345	362
Connecting to GTX 345	362
Using GTX 345	362
GPS and ADS-B from GTX 345.....	363
Calibrating the GTX 345 AHRS.....	364
Garmin GDL 39, GDL 50, GDL 51 GDL 52	365
Connecting to GDL 39, GDL 50, GDL 51, or GDL 52	365
Using the GDL 39, GDL 50, GDL 51, or GDL 52.....	365

GPS and ADS-B.....	367
Calibrating AHRS.....	368
XM Weather Data (Garmin GDL 51, GDL 52, SiriusXM SXAR1)	369
XM Freezing Level.....	371
XM Surface Visibility.....	372
L-3 Lynx	373
Connecting to Lynx.....	373
Using Lynx.....	373
GPS and ADS-B from Lynx	374
Avidyne IFD 550/540/440	375
Connecting to IFD 550/540/440.....	375
Getting a Route from IFD 550/540/440	376
GPS from IFD 550/540/440 and AHRS from IFD 550.....	378
uAvionix echoUAT & SkyEcho	379
Connecting to echoUAT & SkyEcho.....	379
Using echoUAT & SkyEcho	379
GPS and ADS-B from echoUAT & SkyEcho.....	380
Dynon SkyView.....	381
Configuring SkyView Wi-Fi.....	381
Connecting ForeFlight and SkyView.....	381
Sending a Route to SkyView	382
Getting a Route from SkyView	383
GPS and ARHS data from SkyView.....	384
FreeFlight ADS-B.....	385

Connecting ForeFlight and FreeFlight RANGR.....	385
GPS and ADS-B data from FreeFlight RANGR.....	386
SiriusXM SXAR1	387
Connecting ForeFlight to the SXAR1	387
XM Weather Data.....	388
SXAR1 Status Information	388
SiriusXM Satellite Radio.....	388
Connecting a Bluetooth audio device to the SXAR1	390
SXAR1 Audio Controls.....	392
Baron Mobile Link/WXWorx.....	394
Mobile Link Available Weather Data.....	394
Mobile Link Status Information	395
Satcom Direct Router (SDR) or SDR Gateway	396
Connecting to Satcom Direct Router or SDR Gateway	396
Using Satcom Direct Router or SDR Gateway.....	396
GPS and Pressure Altitude from SDR.....	397
DAC International GDC64.....	398
uAvionix SkyEcho 2 FLARM traffic (Europe-only).....	398
FLARM via NMEA (Europe-only)	399
Other Third-Party Devices	399
LogTen Integration.....	400
Flight Simulator Integration.....	401
Before Using a Flight Simulator with ForeFlight Mobile	401

X-Plane	402
Infinite Flight.....	404
Prepar3D/Flight Simulator X.....	405
Redbird.....	405
ELITE	406
AeroFly FS 2	406
Frasca	406
Sharing Flights	408
Twitter.....	408
Email.....	408
Weather Legends	409
Radar Legends (when from Internet)	409
Rain - Radar Intensity (dBZ) vs. Color.....	410
Mixed Rain/Snow - Radar Intensity (dBZ) vs. Color	411
Snow - Radar Intensity (dBZ) vs. Color	412
Four-color Radar - Radar Intensity (dBZ) vs. Color.....	413
Baron Mobile Link/WXWorx XM Radar Intensity (dBZ) vs. Color.....	414
Cloud Tops (ADS-B).....	415
Icing Legend (Internet & XM).....	416
Turbulence Legends.....	417
Light Aircraft (takeoff weight of 15,500 lbs or less).....	418
Medium Aircraft (takeoff weight of 15,501 to 299,999 lbs).....	418

Heavy Aircraft (takeoff weight of 300,000 lbs or more).....	418
Surface Analysis Legend (Internet & XM).....	419
Radar Legends (when from Internet)	420
PIREP Legend.....	420
Enhanced Satellite.....	421
Color IR Satellite	423
Learning More	425
Pilot's Guide Change History	426

Introduction

This pilot's guide provides an overview of ForeFlight Mobile and its capabilities on the iPad. After reading this guide, you will have the ability to:

- Plan flights quickly
- Gather preflight intelligence information efficiently, and
- Use ForeFlight Mobile to best support your type of flying.

This guide presumes a basic level of proficiency with general iPad use and navigation. If you are new to Apple iOS devices, including the iPad, you will want to *view the guided tours* available on Apple's website at www.apple.com/ipad/guided-tours/ as well as the iPad User Guide at support.apple.com/manuals/

iPad Tips

There are a few handy iPad features you'll want to know about when using ForeFlight Mobile:

❖ **Multiple Orientations:** The iPad supports portrait (tall) and landscape (wide) orientations. When you rotate an iPad from one orientation to another, an application typically alters its user interface to better take advantage of the space supplied.

❖ **Rotation Lock:** Having the screen content rotate when you rotate the iPad isn't *always* a good thing. Rotation lock is helpful for preventing Terminal Procedure rotation or accidental rotation in turbulence. Fortunately, you can choose when the screen rotates and when it doesn't. There are a few methods for locking the orientation of content on your iPad's screen:

Newer iPads - iPad Soft-Lock: Swipe down from the upper-right corner of the screen to open the Control Center and find the rotation lock soft-button.

Older iPads - Physical Switch: A physical switch is located immediately above the volume buttons on the right side of some older iPad models. When switched on, this prevents an application from changing its orientation as you change the orientation of the iPad. On some iPads, this switch instead functions as a "mute" switch. You can change the function of this back to a "lock" switch by using the iPad's **Settings** application. Tap *General*, and use the options in the *Use Side Switch to:* section. If this section is not displayed, you may need to update your iPad's version of the iOS operating system to enable this.

ForeFlight Procedures Lock: ForeFlight Mobile also provides a soft-lock switch on the **Procedures** viewer for more flexibility.

❖ **Settings App:** The iPad includes a special application called Settings. Within Settings, you can modify the way the iPad and its applications behave. ForeFlight-specific settings are addressed in the Settings section of this guide. All ForeFlight settings are available in the *More* view of ForeFlight Mobile as well.

❖ **Brightness Control:** There is a brightness control accessible in iPad Settings app. It is also available for quick access in the Control Center by swiping-up from the bottom of the screen. This control is helpful for reducing brightness at night, or for dimming the screen during the day to preserve battery life.

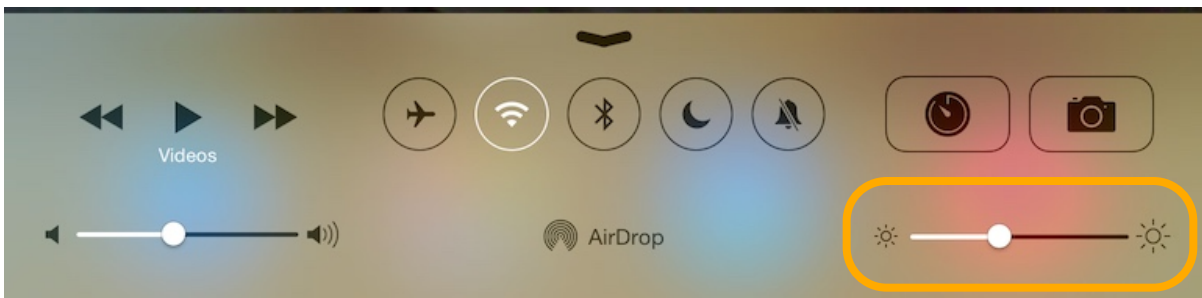

For night use, if the iPad brightness control set to full dim (slider all the way to the left) doesn't dim the screen enough, use the brightness slider in ForeFlight Mobile in the **More** view or at the top of the [Maps Settings](#) menu to dim the screen further. The ForeFlight brightness slider integrates with the iPad's brightness slider, but allows for additional dimming beyond the lowest setting of the iPad's slider.

Setting-up ForeFlight Mobile

First, download ForeFlight Mobile to your iPad or iPhone from the Apple App store. See www.foreflight.com/support/getting-started for detailed instructions.

IMPORTANT: DO NOT install ForeFlight onto a new device from an iCloud backup. If after setting-up a new device from an iCloud backup ForeFlight Mobile is already installed, you should delete the app from the new device and reinstall it directly from the Apple App Store.

If this is your first time using ForeFlight Mobile on that device, you'll get a 30-day free trial of the data. The free trial includes all standard (not Pro) features, but you won't be able to "bulk download" charts and plates for different states.

You can purchase a subscription anytime at www.foreflight.com/buy.

If you have a subscription, follow these steps:

❖ **Sign in:** Your ForeFlight Mobile subscription is associated with your email address. This address **does not have to be the same** as the AppleID email address used in the Apple App store. Sign in on the More > Accounts tab. See [Signing in to your ForeFlight account](#).

❖ **Choose Chart Data to Download:** See [Select Data to Download](#). Tap on **More > Downloads**, then tap on the Country area(s) for which you have a subscription. For example if you have a US subscription, you would tap on United States. Choose the types of charts to download, then scroll down and select (tap) each state you want to download. Then tap the **<Downloads** button to go back to the Download status page, and tap the blue **Download** button to download the data.

❖ **Confirm Data Sync:** If you have previously used ForeFlight Mobile 6.2 or later on any device(s), your User Waypoints, Favorites (Routes, Airports, Plates, Imagery) and Recents (Routes, Airports, Plates Imagery) will automatically be loaded after you sign-in. If you have lots of User Waypoints, Favorites or Recents, it may take a few minutes for the data to load.

❖ Tap on **Documents > Drive** and choose any [documents](#) you would like to have in-flight. The Pilot's Guide is in the ForeFlight category; the FAA category has A/FD Supplementals, Legends, and FAR's and FAA Handbooks.

Before flying, be sure to complete the [pre-flight check](#), including Downloading Data, and [use Pack](#) to confirm you have charts, METARs, NOTAMs, TFRs and Fuel prices covering your route.

You should also take a few minutes to set up the Day and Night App Themes to your liking. Settings for the App Themes are found at the top of the [More > Settings](#) menu.

The App Theme button allows you to quickly change between Day and Night themes, and you can choose the App Color, Aeronautical Map Theme, and whether to invert the color of Plates, Charts, and Documents, as well as Jeppesen Maps (if you have a purchased or linked Jeppesen subscription).

You can switch between Themes by tapping the respective button, or choose the “Auto” setting to automatically switch at sunrise and sunset based on your local time.

If you have Day or Night Theme selected and you make an adjustment to one of the settings, for example changing the Invert Plate Colors setting on the Plates page, that setting is automatically reflected in the Day or Night Settings menu.

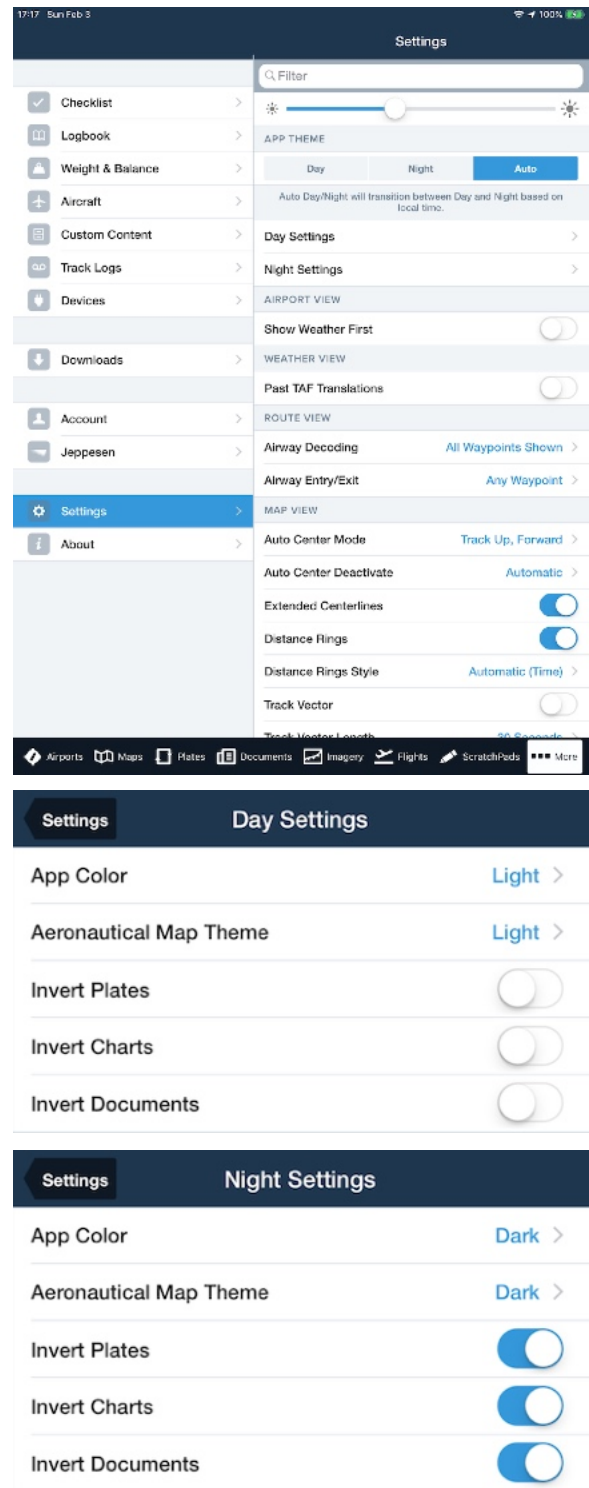

Search in ForeFlight Mobile

ForeFlight Mobile's unified App Search has a consistent look-and-feel across the Airports, Maps, Plates, and Documents tabs. The current tab shows-up as the first category in the results, and you can scroll down for other categories. Each result type has a different icon, and Document searches currently encompass only the title, not the body of the document. Open a document to search inside it.

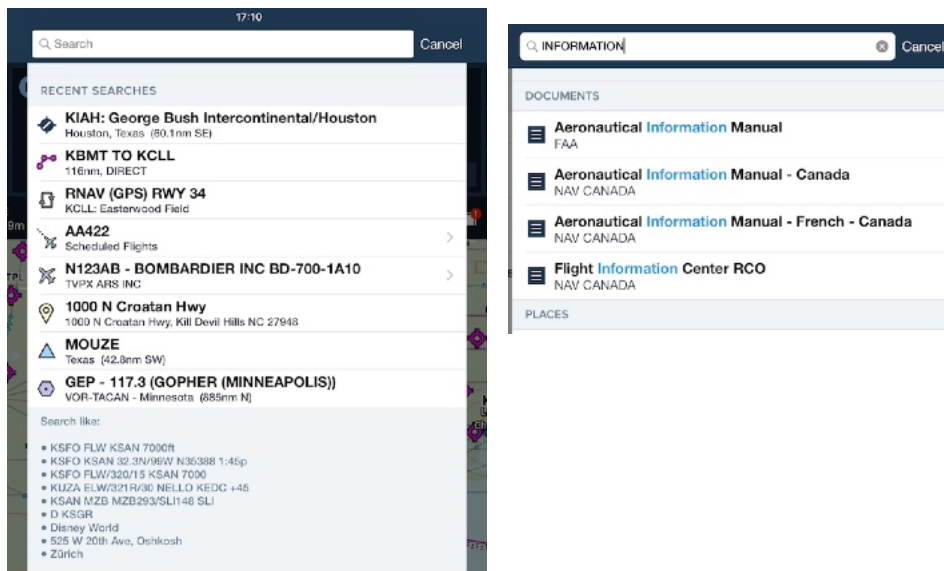

- Routes
- Airports
- Aeronautical information, such as nav aids by name or identifier, and waypoints
- Procedures, including searching by type such as "GPS", "RNAV", or "ILS"
- Cities, including airports associated with or near a city
- Street Addresses & Intersections (Internet connection required)
- Aircraft (N-number) and Scheduled Flight information by flight or callsign
- Documents

Delete recent searches by swipe-deleting from right to left across the search result, then tapping the red "Delete" button.



Planning a Flight

The form-based flight planning option on the Flights view replaced the “File & Brief” view. Form-based flight planning compliments and enhances the familiar Maps based Flight Plan Editor and touch planning options that are still available. You can start flight planning on either the Maps page or the Flight page, and easily transition between the two as needed.

If you have a Performance Plus subscription, please refer to the Performance guide (available in the app in Documents > Drive > ForeFlight) or online at <http://foreflight.com/support/performance/pdf> for additional details about the Performance flight planning features.

Planning a flight using the Flights form

To start planning, enter a departure and destination (and [alternate](#), if needed) and an ETD. Tap the “Info” button to display the familiar Airport popup from the Maps page. If your ETD is more than 6-7 days in the future, ForeFlight will use historical winds to calculate performance, based on the average wind speed and direction along your planned route over the past 40 years.

The top row shows a route performance summary that updates as you make changes to the flight. Tap the circular arrow “Refresh” button to update the summary with the latest data if you’re returning to a Flight you started previously.

Select the aircraft and performance profile, then enter your desired route or choose one using [Route Advisor](#). Route Advisor provides ATC-cleared routes (if available) as well as Preferred, TEC, and Airway routes.

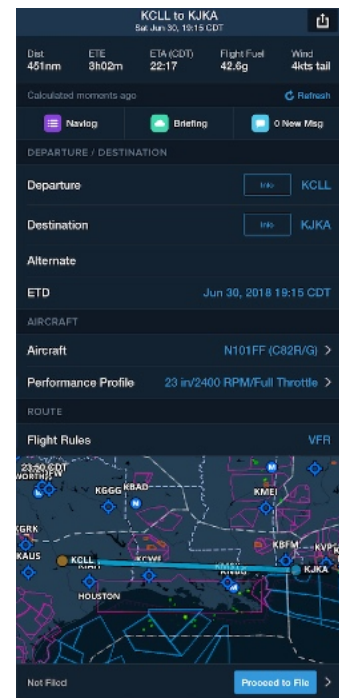

You can copy a Filed or Expected route from a previously-filed plan to the iOS clipboard (for use in ForeFlight Mobile or in other apps) by tapping on that plan, tapping the “Filed” button at the bottom of the page, then touch-holding the Filed or Expected route, and choosing “Copy”. You can then paste that route into the route in the new Flight.

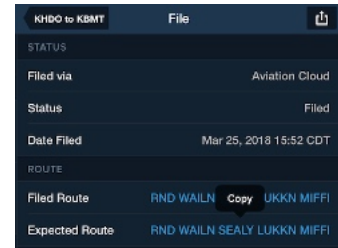

A dynamic map built into the Flights view allows you to see your route and overlaid composite radar. Tap on the map to expand it to an interactive “half-screen” mode, then tap the button in the upper-left labeled with your departure & destination (eg: KCLL to KJKA from the first example above) to return to the planning form.



Tap the Cruise Altitude line below your Route to open an Altitude Advisor pop-up, which shows the net effect of winds along your entire route at different altitudes.

Tap the “Briefing” button to generate a graphical weather briefing, and tap the “Navlog” button create and email (or print) a detailed Navlog.

At any point in the planning process you can send a Flight to the Maps page by tapping the “Send to” button in the upper-right corner and choosing Map. If you make further modifications on the Maps page, you can send them back to Flights by tapping the “Send to” button at the bottom-right of the Flight Plan Editor and choosing “Flights.”

Destination Services

While planning on the Flights form you can optionally select an FBO providing fuel at your destination airport using the **FBO** selector under Destination Services. Tap “Details” on any FBO in the list to view its full Directory listing, including photos, user-submitted comments, and contract jet fuel prices if you’ve linked a JetFuelX account (requires the Performance Plus subscription plan). Tap “Select FBO” at the bottom of the Directory listing, or tap on any FBO in the previous list to select it.

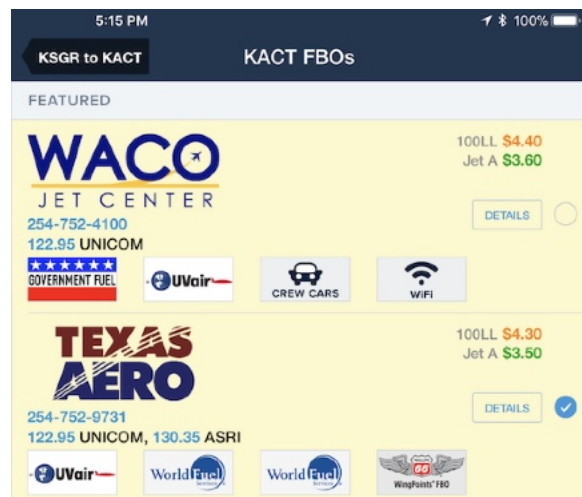
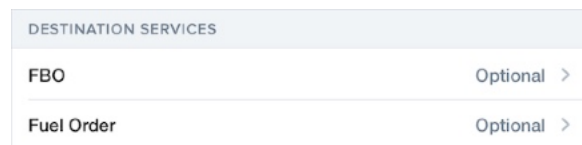

The FBO selector now shows the FBO's name, frequency, and lowest available price for the fuel type used by the selected aircraft. Four buttons provide quick access to common needs - tap the telephone button to view and call the FBO's phone

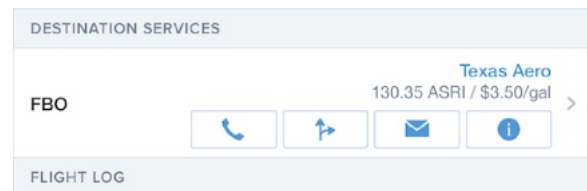

number, tap the 'routes' button to open Apple Maps and zoom to the location of the FBO, tap the mail button to draft an email to the primary email address of the FBO, and tap the "i" button to view the full Directory listing for the FBO. You can remove your FBO selection by tapping on it to view the FBO list, then tapping on the selected FBO to de-select it.

When you select an FBO for a given airport, ForeFlight will automatically select the same FBO on the next flight you plan to that airport.

If planning a multi-leg trip, use the "Add Next Flight" button at the bottom of the planning form to create a new flight that retains the most important details from the previous one, making it easy to plan consecutive trip segments. Add Next Flight sets the destination airport of the previous flight as the departure airport of the new flight, and sets the new flight's ETD to 30 minutes after the ETA of the previous flight, if that time has not already passed. Add Next Flight preserves the first flight's aircraft and performance profile, and if you have a Performance Plus subscription it will also use the same payload details and fuel policy as the previous flight.

When you have finished planning, tap the "Proceed to File" button to file a flight plan.

Navlog, Briefing, Messages

Tap the “Navlog” button to view a detailed Navlog, including leg times, winds, and fuel burns; winds at altitudes above and below your planned altitude; and frequencies for the airports and selected FBO. The Navlog can be printed (on an available AirPrint printer) or emailed. You can also view the Navlog on a computer by signing-in at plan.foreflight.com and clicking on the Flights menu. Navlogs generated on the web will automatically become available on mobile as part of ForeFlight’s [Sync](#) system, and vice versa. Navlogs include space to record actual leg times and with a Performance plan, space to record actual leg fuel burn.

Pilots using a Performance plan can also select an “International” template that some operators may prefer for international flights. It includes additional space for note-taking including ATIS, clearance, as well as inflight actuals and remarks. While viewing the NavLog, tap the “Gear” button and select the desired template

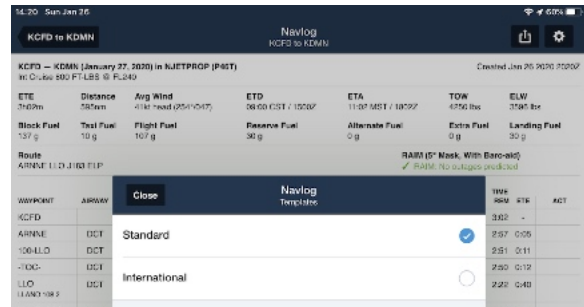

Performance Plus Navlog

Standard template

International Template

Basic Plus/Pro Plus Navlog

KCFD to KLB Navlog
KCFD to KLB

KCFD — KLB (May 26, 2019) in N103FF (C182) Created May 28 2019 14:16Z

Basic Performance Profile @ 8000'

ETE	Distance	Avg Wind	ETA	ETA	Flight Fuel	Taxi Fuel
2h42m	345nm	4kt head (218/008)	10:15 CDT / 1515Z	12:57 CDT / 1757Z	42 g	1 g
	1 g	42 g				

Route: CLL ACT

Waypoint	Altway	MAG	HCG	CRS	ALT	CRP	DRG	SPD	ISA	SRD	KT	LEG	HEM	LEGS	TRNG	ETE	ACT
KCFD		-	-	357	-	-	-	-	+11	0	0	-	345	-	2:42	-	
CLL		ECT	308	212	3200	M22	187/027	+11	105	83	8	337	0:06	2:35	0:06		
-TOC-		DCI	308	323	8000	T22	190/031	+14	105	127	20	317	0:09	2:37	0:15		
ACT		DCI	318	322	8000	T11	206/025	+16	135	146	67	260	0:23	2:04	0:28		
WAD		DCI	318	322	8000	T11	206/025	+16	135	146	67	260	0:23	2:04	0:28		
200-KLBB		DCI	282	295	8000	H5	216/030	+16	135	130	60	300	0:25	1:35	1:06		
100-KLBB		DCI	281	293	8000	H0	200/028	+15	135	126	100	100	0:48	0:48	1:54		
-TOC-		DCI	284	292	8000	H11	204/021	+14	135	124	81	19	0:39	0:39	2:33		
KLB		DCI	281	290	3262	H7	251/021	+15	125	118	10	-	0:00	-	2:42		

Winds Aloft	4000 ft (ISA -1°C)	6000 ft (ISA -1°C)	8000 ft (ISA -1°C)	10000 ft (ISA -1°C)	12000 ft (ISA -1°C)
CLL	(030) 186/033 +12	(034) 206/034 +15	(014) 223/015 +14	(014) 223/015 +18	(04) 250/005 +15
-TOC-	(121) 193/033 +12	(115) 202/036 +15	(19) 169/014 +15	(19) 169/014 +19	(14) 210/012 +16
ACT	(120) 193/031 +12	(115) 212/039 +14	(18) 212/025 +15	(18) 212/025 +19	(15) 214/017 +16
200-KLBB	(14) 195/028 +14	(048) 214/038 +14	(010) 224/028 +15	(010) 224/028 +18	(01) 207/028 +16
100-KLBB	(00) 230/018 +10	(012) 245/018 +15	(009) 228/023 +13	(009) 228/023 +17	(011) 214/041 +15
-TOC-	(012) 256/015 +20	(012) 250/017 +14	(010) 228/023 +10	(010) 228/023 +14	(012) 215/044 +13
	2h42m @ 271, 28 g Avg wind comp: 18	2h39m @ 270, 41 g Avg wind comp: 12	2h42m @ 270, 41 g Avg wind comp: 18	2h39m @ 265, 41 g Avg wind comp: 18	2h39m @ 265, 41 g Avg wind comp: 12

Summary & Times

PIC: _____

Tail: N103FF (C182)

Profile: Basic Performance Profile

Distance: 345nm

Navlog updated: May 28 09:16 CDT Moments ago

Buttons: Airports, Maps, Plates, Documents, Imagery, Flights, ScratchPads, More

KCFD to KLB Navlog
KCFD to KLB

KCFD — KLB (May 26, 2019) in N103FF (C182) Created May 28 2019 14:16Z

Basic Performance Profile

Distance: 345nm

ETA: 10:15 CDT / 1515Z

ETE: 2h42m

ETA: 12:57 CDT / 1757Z

Route: CLL ACT

Altitude: 8000'

Altitude	WK	TWD/CTAF	CLR	GND	ELEV	LONGEST RWY
KCFD	125.075	123.0	N/A	N/A	387	15 / 33
KLB	125.3	120.5	128.5	1.21.5	3282	17R / 26L

KCFD Counter Field

KLB Lubbock Preston Smith International

Navlog updated: May 28 09:16 CDT Moments ago

Buttons: Airports, Maps, Plates, Documents, Imagery, Flights, ScratchPads, More

Tap the "Briefing" button to request a ForeFlight briefing. To update an already-received Briefing, tap the circular arrow "Refresh" in the upper-right of the Flights view, or open the Briefing then tap the circular arrow "Refresh" button in the lower-left corner of the briefing. For more details about the briefing, refer to the [ForeFlight Briefing](#) chapter later in the guide.

If a message is received related to TFRs, airport/runway closed/unsafe NOTAMs, urgent PIREPs, SIGMETs, Convective SIGMETs, AIRMETs, Center Weather Advisories (CWAs), and Severe Weather Watches/Warnings that affect your filed route, "# New Msg" button will update to show the number of messages. Tap the button to view any messages received for a filed plan.

For more detailed information about filing flight plans, refer to the [Flights](#) chapter later in the guide.

Planning a flight on Maps using the Flight Plan Editor

Tap the “FPL” button in the menu bar to display the Flight Plan Editor, then tap on the “Edit” tab and type the Airport IDs, NAVAIDs, Airways, etc... that you want to be part of your route. You can use a combination of typing and Touch (eg: rubber-banding a route by touch-holding on a route line and dragging it to the desired location) to plan the route.

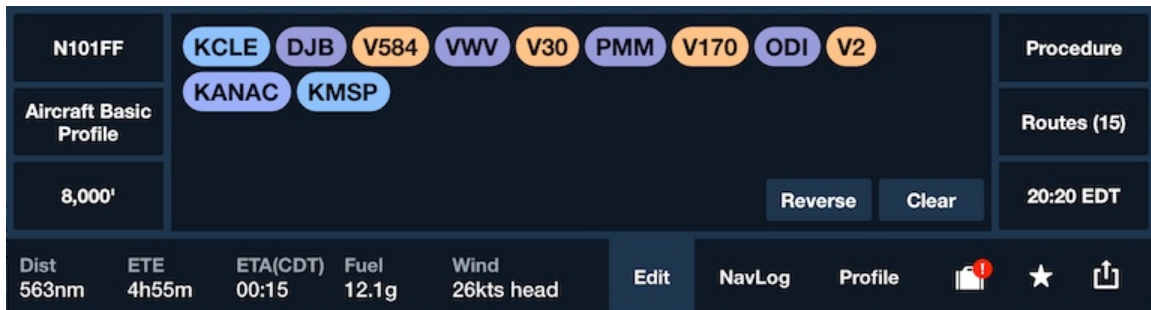

Use the buttons on the left side of the Flight Plan Editor to choose the aircraft, performance profile and to open the Altitude Advisor, and use the buttons on the right side to open [Route Advisor](#), to pick a Departure, Arrival, and/or Approach, and to set the Estimated Time of Departure (ETD). See the [Flight Plan Editor](#) section later in this guide for additional details.

If an Airport or Runway Closure NOTAM exists for an airport in your route, it is indicated by a read warning icon on the airport’s route bubble. Tap the bubble and choose “View Alert NOTAM...” to see the NOTAMs.

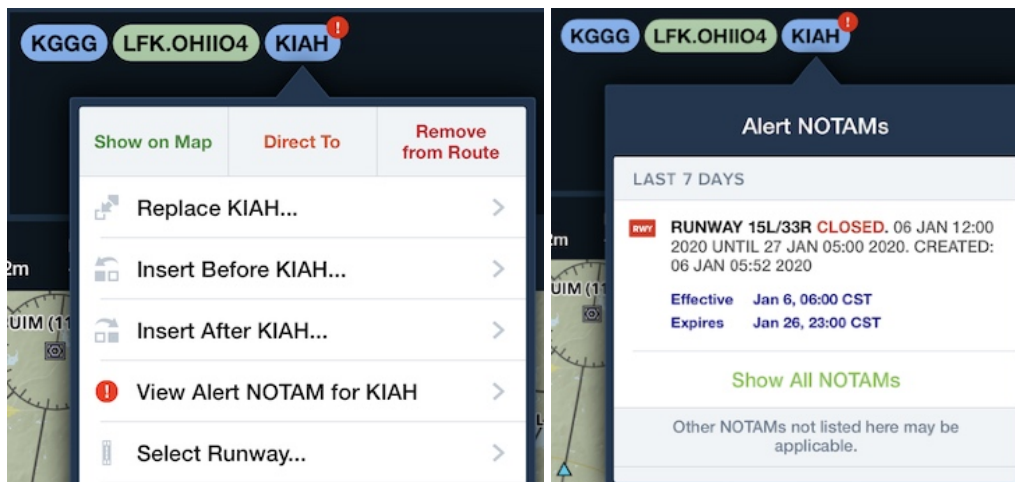

Planning a flight on Maps using Touch

You can also create or edit a route using a single finger with ForeFlight Mobile's "Touch Planning." Touch Planning is based on touch-and-hold gestures on the Map: place your finger on a waypoint or other location on the map and hold it there for a second. A dialog will appear asking you to specify which location near your touch point should be used.

❖ **Add** a waypoint to your current route, or **start a new route**: Touch-and-hold until a popup is displayed. Then, select the desired waypoint in the popup by tapping the name. If you already have a route on the map, the new waypoint will be added to the end.

❖ **Remove** a waypoint from your current route: Touch-and-hold on the waypoint. Tap the **Delete** button in the top right of the popup. You can also short-tap on the route leg preceding the waypoint and tap **Delete** in the top right to remove the waypoint.

❖ **Insert** a waypoint in the middle of an existing route leg: Touch-and-hold on the route leg line until it turns blue. Then, keeping your finger on the screen, drag to the location you want to add. Remove your finger from the screen and select the desired waypoint from the popup view by tapping its name. Or tap **More** to see additional options: **Direct To**, **Add to Route**, or **Details**.

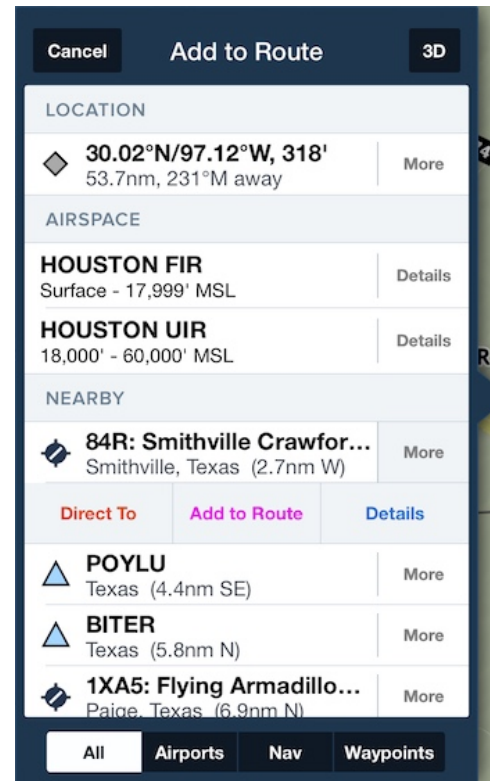

The popup view that appears as part of touch planning allows you to select from a list of locations near your touch point, sorted by distance. The list shown is filtered by *All* (which includes airspaces), *Airports*, *Nav* (VORs, NDBs), and *Waypoints* (intersections and user waypoints). To change the filter mode, tap the buttons in the bottom of the popup view.



To cancel a touch planning operation, tap the **Cancel** button that appears in the popup view or tap the map outside the popup view.

When Adding a waypoint using touch, the popup window shows an icon next to the name to help identify the type of waypoint:

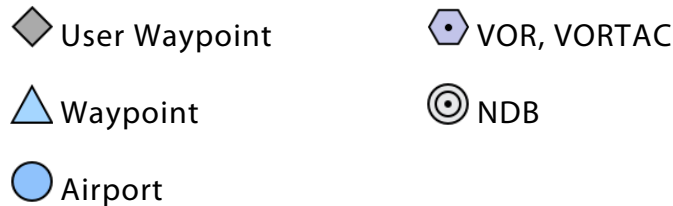

Tap the **“More”** button next to an entry in the popup to show additional options for that entry (see following example for 84R):

Tap the orange **Direct To** to make a new route direct to that airport or waypoint from your present position.

Tap the magenta **Add to Route** to add that airport or waypoint to the end of the route.

Tap the blue **Details** to see that airport’s or waypoint’s detail view.

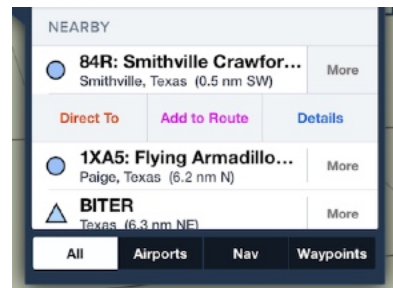

To add a User Waypoint or a waypoint from a KML layer to a route, tap the point then tap **Add to Route**.

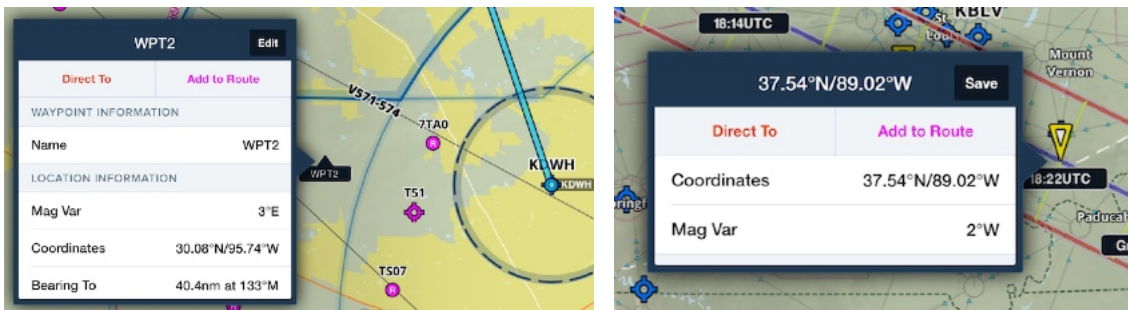

To add an address search result, tap the result in the search box, then tap **Add to Route** on the Maps page.

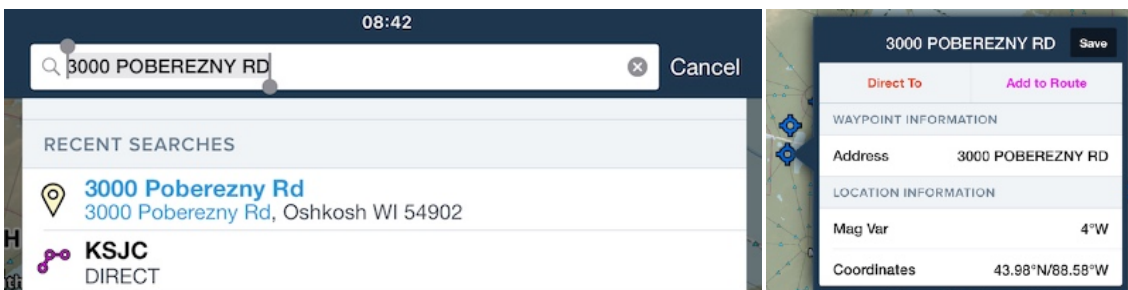

To fly direct to a point from on route, tap the point then choose **Direct To**. To delete a point from your route, tap the point then choose **Remove from Route**.

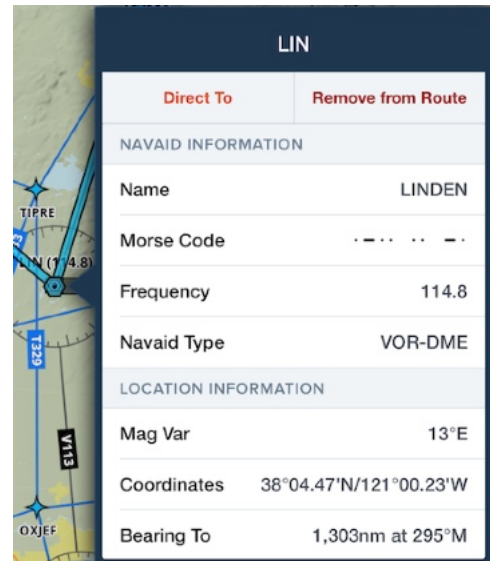

Planning a flight using Search

Create a route by typing in the Search box on any of the Maps, Airports, or Plates tabs by typing multiple identifiers in a *Search* box, separated by a space, in the order in which you will visit them.

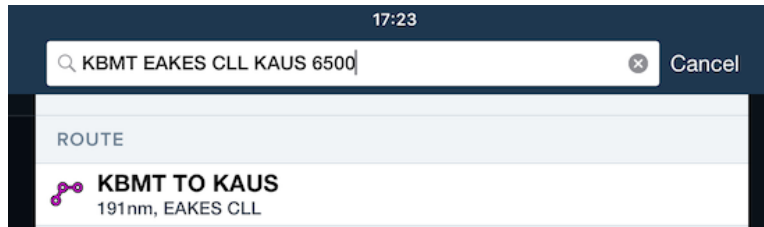

When typing a search, look for the hints that appear underneath the search box. These hints provide example route searches that act as great reminders for quickly visualizing your route.

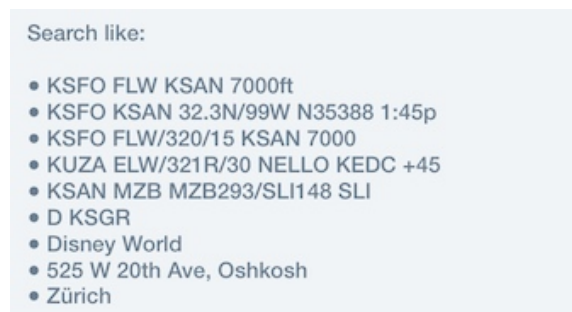

Any of the search options specified in the [“Finding an Airport or Navigation Aid using Search”](#) section are supported as route waypoints. Additionally airways, arrivals and departures are supported, as well as any custom waypoints you have created.

Your current location, if it can be determined, can be used as the origin for your route, as in the last example in the screenshot above: D KSGR. ForeFlight will replace the “D” with the coordinate for your position.

Entire airways can be viewed on the map by searching for just the airway identifier, for instance: *V16*. Airways can also be used in a route, just as ATC would issue them. For example: *NIKOL V244 ILC*. ARINC 424 coordinates (ex: 5275N) can also be entered in the Search box or Route Editor.

DPs and STARs (as well as associated transitions) are also supported in a route. If the DP or STAR requires a runway input, ForeFlight Mobile will prompt you for one and provide an example. When briefing and flying these procedures, it is critical to *always* refer to the official arrival/departure plate from the Airport view as the

ForeFlight Maps view is *not able to show heading vectors, altitude info, and certain other details you'll need.*

When building a route in the search box you can also provide basic performance information about your aircraft. These can be in any order, but must come after the route waypoints. These include:

- ❖ **Altitude** in feet.
- ❖ **KJFK KSFO** - this is a simple direct route from NY to San Francisco.
- ❖ **D KSFO** - this is a direct route from your current position to San Francisco.
- ❖ **KJFK FLW 32.3N/99W** - this is a route from NY to the FLW VOR to a lat/lon waypoint.
- ❖ **KSFO FLW/320/15** - this is a route from KSFO to a point on the 320 radial 15nm from FLW VOR. If a VOR is not given as the reference waypoint, then the directional information is assumed to indicate a bearing, not a radial. Enter "M" after the bearing to position the point on the magnetic bearing; enter "T" after the bearing to position the point on the true bearing.
- ❖ **KCLT RDU J209 ORF J121 SIE.CAMRN4 KJFK** - this route includes multiple jet airways and an arrival.
- ❖ **KUZA KOSH 8000ft** - this is a route from Rock Hill to Oshkosh at an altitude of 8,000'. The selected aircraft's performance profile is used because fuel burn and true airspeed cannot be entered in the Search box.
- ❖ **KJFK YQM V311 YQX 5050N 5330N 5315N EGLL** - This hypothetical route from JFK to London Heathrow uses ARINC 424 coordinates between Gander and Heathrow. See http://code7700.com/arinc_424_shorthand.html for additional information.

A route search can also include a *tail number* of an aircraft setup in the **More > Aircraft** view. When that aircraft has performance data it will be automatically used.

Lastly, you can also indicate a departure time in your route search; ForeFlight will use this time to incorporate the proper winds aloft forecasts into your time and fuel usage calculations. If you don't provide a time, ForeFlight Mobile assumes you are departing ASAP. You can include the departure time as a specific time or as a time relative to *now*, as a local time or Zulu time, NOTE: since the iPhone does not have the ETD button you *must* enter a departure time to see an ETA.

- ❖ **KUZA KOSH 8000 1315Z** - The route details will be calculated for conditions starting at 1315Z. The time can be designated in Zulu time, as in the example, or

local time, such as: **13:15**, **1:15p**, **1:15pm**, **1:15a**, **1:15am**, or **1:15** (with no am/pm given, ForeFlight will assume you desire the next upcoming 1:15).

❖ **KUZA KOSH 8000 +60** - The route details will be calculated for conditions starting 60 minutes from now. This relative time *must* begin with a + and may be specified in minutes, hours, or a combination; **+60** or **+60m** for minutes, **+2h** for hours, **+2:30** for 2 hours 30 minutes.

A route entered in Search will automatically be transferred to the Route Editor. If you enter a new route in the Search box it will replace the route in the Route Editor. To clear the current route from the Search box, tap the “X” in the Search box. To clear the route from the Route Editor, change to the Edit view and tap the Clear button, then tap “Clear All.”

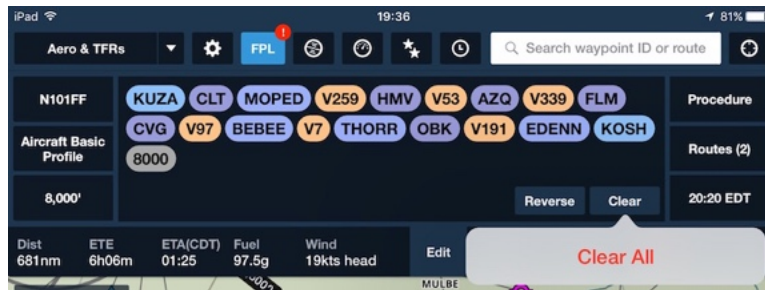

Search for N-number or Scheduled Flight

You can use the Airports, Maps, or Plates Search bar to find Scheduled (upcoming) flights for an aircraft and load them into the Route Editor. Search by tail number (e.g. N12345), call sign (e.g. NGF345), or commercial flight number (e.g. SWA44). ForeFlight searches FlightAware for any flights that are either currently enroute or set to depart in the next 24 hours and displays those flights in a list. Each flight listed includes the departure and destination airports, the filed altitude, the departure time, and the filed route. Tap on a flight to load the route and altitude into ForeFlight’s flight plan editor.

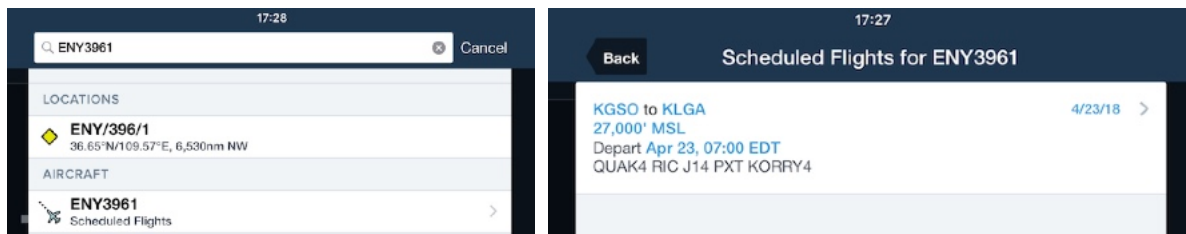

3D Review

3D Review is a powerful flight planning and debriefing tool that allows you to review the path of a planned (or recorded flight) with aerial imagery overlaid over high-resolution 3D terrain. You can use it to prepare for an upcoming flight by familiarizing yourself with landmarks and ground features along your planned route, and you can replay a past flight with pitch and bank data (if the Track Log was recorded from an AHRS-capable device) to evaluate your maneuvers. 3D Review is included in ForeFlight Performance plans.

Access 3D Review by tapping the 3D button in the Flight Plan Editor in the Maps view, in a Logbook entry, in the Flights view, or above the graph within a Track Log.

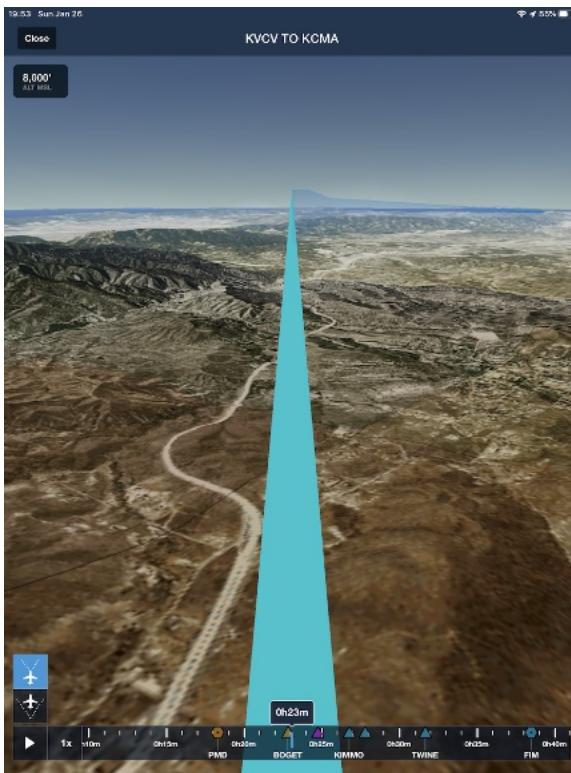

First Person (upper button)

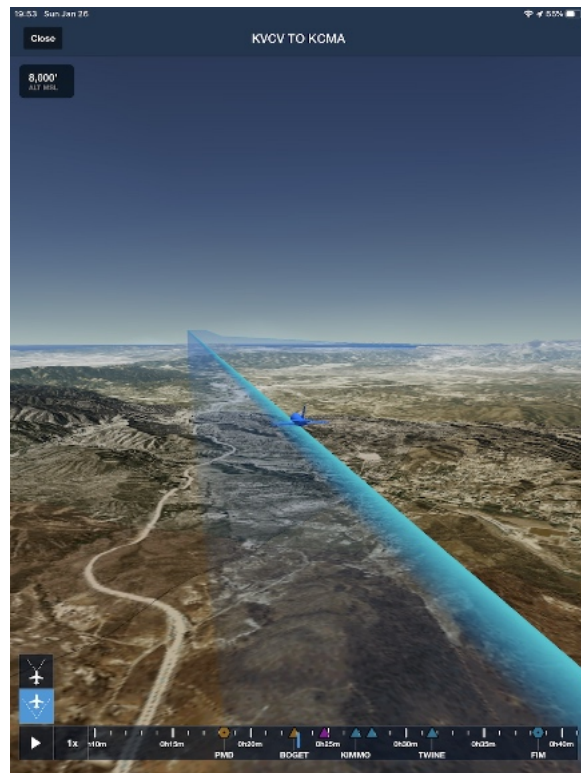

Third Person (lower button)

Use one finger to pan and two fingers to pinch-zoom within the interactive 3D View to get a 360° panorama of the environment along a route. Switch between first person and third person views using the buttons in the lower-left of the screen.

Manually scrub through a flight using the built-in timeline, or auto-play the flight at 1x, 3x, 5x, 10x, or 20x normal speed for a faster overview. The points in the planned route are depicted in the 3D Timeline.



You can use two fingers to pinch-zoom within the timeline for finer moment-by-moment adjustments.

When viewing a Track Log recorded by a device such as a Sentry that supplies AHRS data, tap the AHRS button in the upper-right to toggle between including the pitch/roll, or showing straight-and-level.

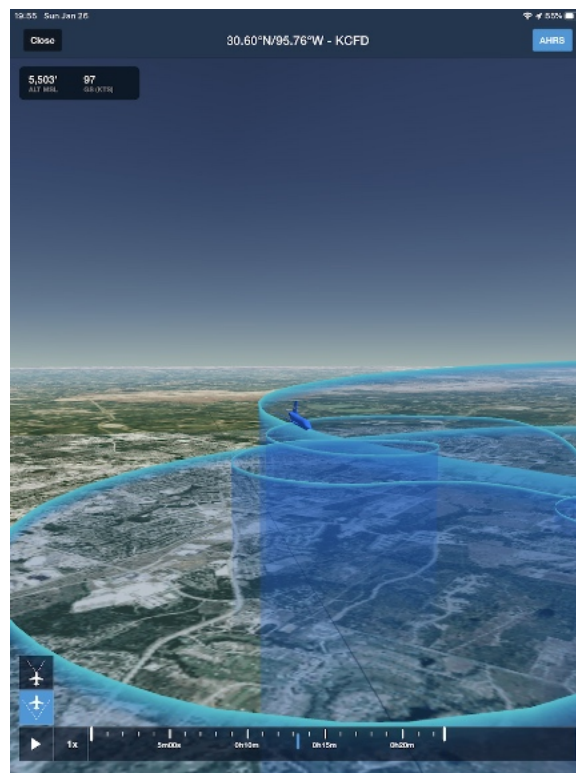

Third Person (lower button) with AHRS (pitch/roll) ON

Airports

The *Airports* view displays airport information, frequencies, airport thumbnail diagrams, taxi diagrams, terminal procedures, service provider details, fuel prices and terminal area weather for over 20,000 airports worldwide.

Buttons located on the *Airports* view menu bar will help you find airports near the current airport, find airports near your current position, display the airport's location in the *Maps* view, and add or remove an airport to your *Favorites* list.

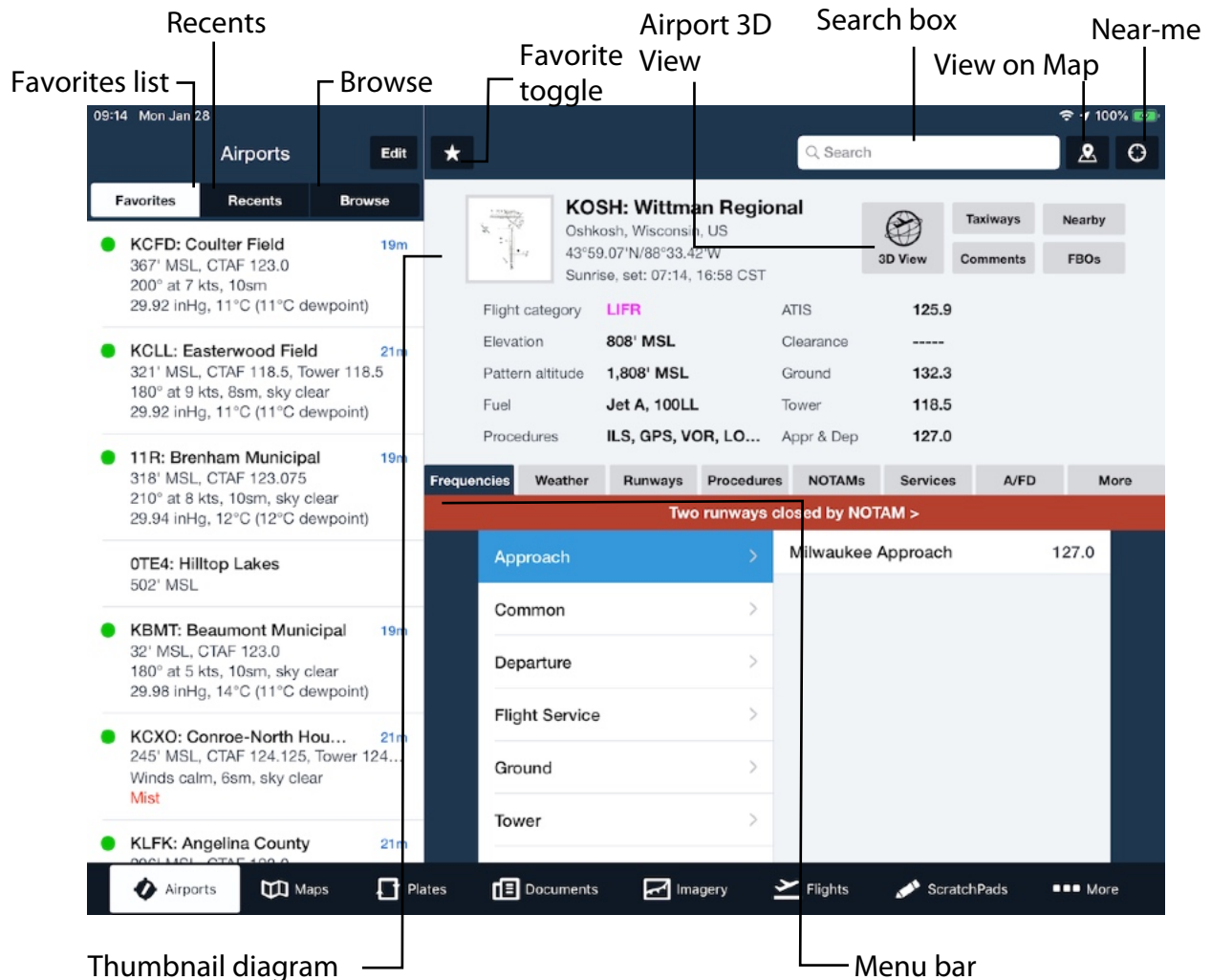

For Performance Plus and Business Performance customers, larger US airports where electronic Pre-Departure Clearances (PDC) are available for IFR flights are noted with the "PDC" badge next to the Clearance frequency.

Clearance **PDC** 128.1

About the Design

The *Airports* view is designed to fill the whole screen, reducing scrolling and the effort required for your eyes to lock on to important airport information. The colors selected reduce brightness, draw attention to the top half of the page, and help highlight critical information.

Airport Detail information is displayed on the top half of the Airports view. Refer to this portion of the view when preparing to taxi or when approaching an airport, as it contains elements such as the current flight rule; field elevation and pattern altitude (estimated or verified in the USA & Canada, verified only in Europe); automated weather frequencies, and controller frequencies. For airports in Europe, the Transition altitude (from VFR to IFR) is shown next to the position, altitude, and sunrise/sunset information.

Additional information from one of the available lower views is displayed in the bottom half of the screen. The views can include airport related frequencies, current and forecast weather, runway details, terminal procedures, notices to airmen, airport services, the Airport/Facility Directory entry, and supplemental airport information.

Finding an Airport using Search

Search is a useful method of finding information and creating flight plans within ForeFlight Mobile. Find airports by entering a search term in the search box, then tapping the 'Search' button displayed on the iPad's on-screen keyboard.

Valid search strings include Federal Aviation Administration airport identifiers (three-letter identifiers), International Civil Aviation Organization identifiers (four-letter identifiers), city name, or keyword.

If ForeFlight doesn't find an instant match for the search term used, a list of close matches will appear.

Example Searches:

- ❖ **KJFK** - immediately displays airport information for Kennedy Int'l.
- ❖ **CDG** - immediately displays airport information for Charles De Gaulle.
- ❖ **Kennedy** - produces a list of all airports with "kennedy" in the airport or city name.
- ❖ **N35388** - returns aircraft information for the tail number N35388, including a link to FlightAware.com to track that aircraft's flights.
- ❖ **KXIH** - shows the METAR and related info for the KXIH weather station

Favorites/Recents/Browse

The button in the top-left corner of the Airports view opens a sidebar containing three lists of airports: Favorites, Recents, and Browse. When in landscape mode, the sidebar is automatically displayed on the left side of the screen.



Finding an Airport Using Browse

The **Browse** tab on the *Airports* view side-bar allows browsing airport listings by country and region. Search is the preferred method for locating airports, but Browse is a helpful option for locating an airport using the same State/City hierarchy you may already be familiar with from using Airport/Facilities Directories.

Tap the **Favorites/Recents** button and tap **Browse** to display the *Airports* List. Use the 'A - Z scroller' on the right hand side of the Airports List to move forward and backwards quickly through the list. Tap the *Global* tab at the bottom of the airports list to view airports outside of the United States.

Favorite Airports List

Use the Favorites list to store frequently visited airports, area airports, and airports for upcoming flights. Having a nicely populated list of favorite airports makes scanning airport conditions a snap.



While viewing an airport, tap the single star button on the Airport view menu bar to add the airport to your Favorites list. Tap the button a second time to remove the airport from your Favorites list.

While the Favorites list is visible, tap any airport listed to display that airport's full information.

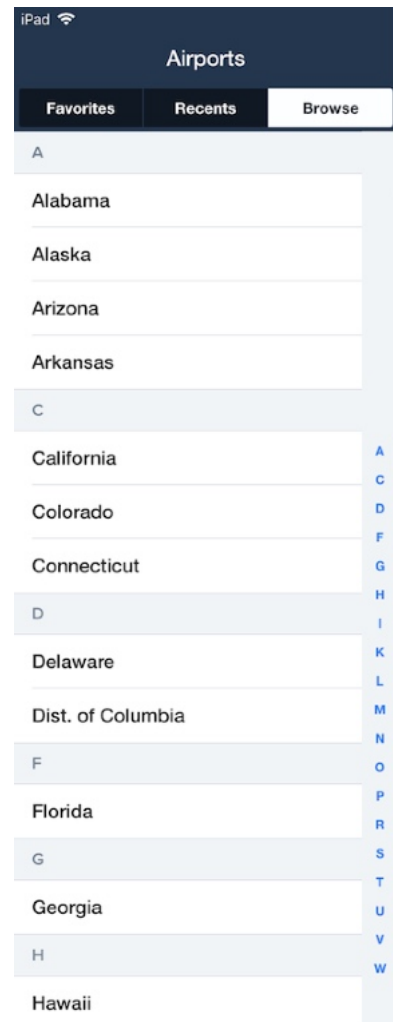

Tap the Edit button in the top-right corner of the Favorites list to reorder or remove airports. Reorder an airport by touch-holding on the stacked lines to the right of the airport, then sliding it up or down in the list. Remove an airport by tapping the red circle to the left of the airport and tapping the Delete button that appears. Tap Done to exit Edit mode.

Airports can also be deleted outside of Edit mode by swiping left across the airport to reveal the Delete button.

Each airport in the Favorites list displays the most recent weather information for the airport (if available).

Information displayed includes the current flight rule, observation age, wind speed and direction, ceiling, barometric pressure, temperature, and dew point. Weather warnings (e.g., fog, thunderstorms, cumulonimbus clouds, lightning, mist) - are displayed and highlighted in red when present. ForeFlight Mobile automatically checks for updated weather observations every minute. If a more current observation is available, it is downloaded immediately and the display is updated.

ForeFlight uses the following convention for conveying the airport's current Flight Category:

- Green** **VFR**
- Blue** **MVFR**
- Red** **IFR**
- Magenta** **LIFR**

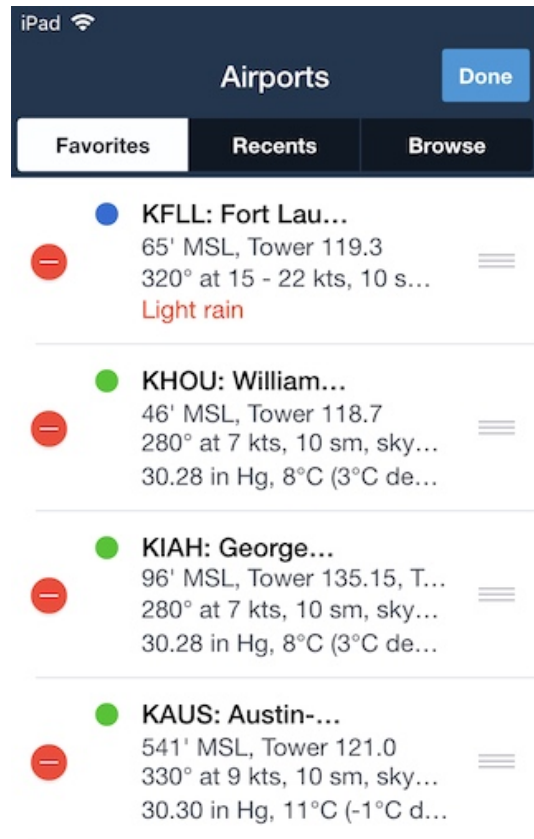

Recent Airports List

Tap the Recents tab to display a list of airports you've viewed in reverse-chronological order.

To remove airports from the Recents list, there are two methods available: *clear* and *swipe-to-delete*. Tap the **Clear** button to remove *all* airports from the list. To remove a single entry from the Recents list use the standard Apple 'swipe-to-delete' function: swipe your finger across the airport, then tap the red "Delete" button.



Favorite and Recent Airport Sync

Changes to your Favorite and Recent airports, including adding, removing and changing the order of Airports, are automatically synchronized to each device that is signed-in to your ForeFlight Mobile account. For more information, see the [Sync chapter](#).

Airport 3D View

Airport 3D View provides a dynamic 3-dimensional preview of the airport environment combining high-resolution terrain data and aerial imagery to help you familiarize yourself with the airport environment before arrival.

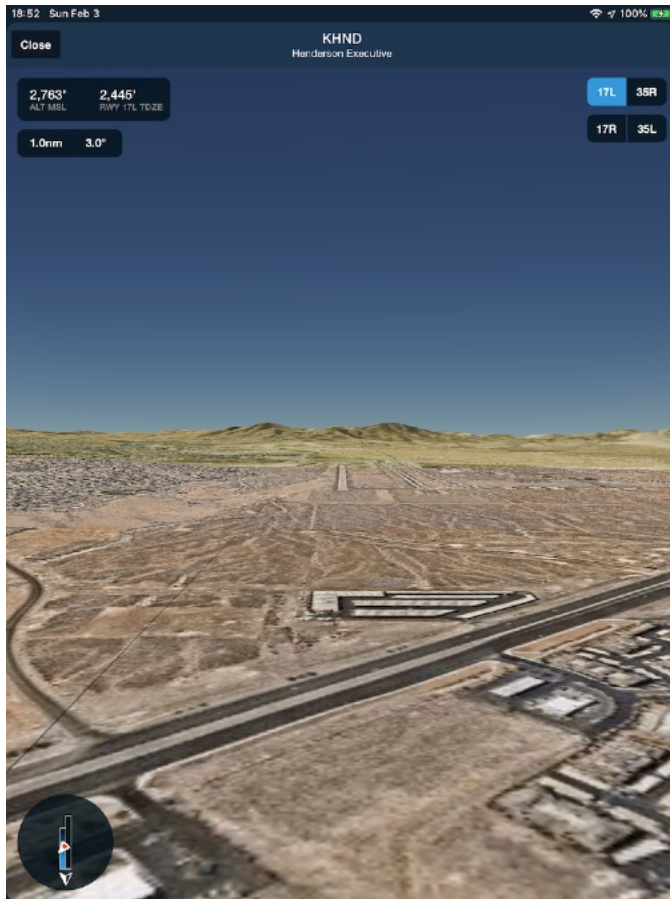

iPad 3D View

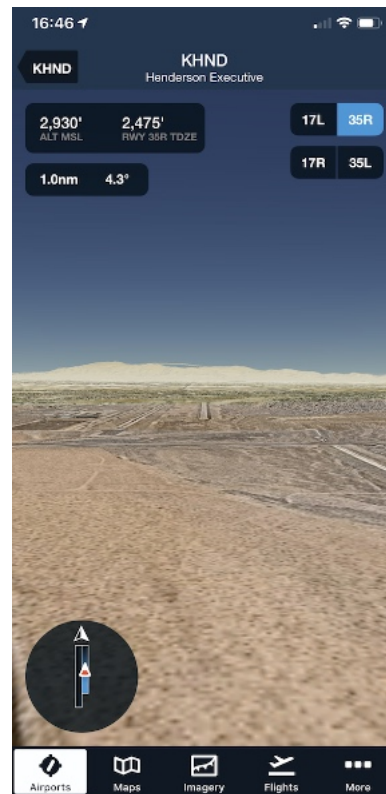

iPhone 3D View

Selectable runway buttons in the upper-right allow you to visualize straight-in approaches by automatically positioning the camera 1 nm from the runway threshold along the published glideslope (or at an inclination of 6° if no glideslope information is available).

Use a single finger to pan the view around and the 2-finger “pinch to zoom” to zoom the view out up to 15 nautical miles from the airport. A data readout in the upper-left corner of the view provides information about the runway and current camera elevation, and the distance and angle of the camera from the end of the selected runway.

When Airport METAR data is available a windsock icon appears over the selected runway icon in the lower-left. In the examples above, the icon on the iPad screen

indicates a headwind with right crosswind, and the icon on the iPhone indicates a tailwind.

The Airport 3D View uses high-resolution Aerial imagery, which is cached in memory the first time you view it for a particular airport. Use Pack before the flight to save the 3D View Aerial Imagery for all of the airports currently added to your route.

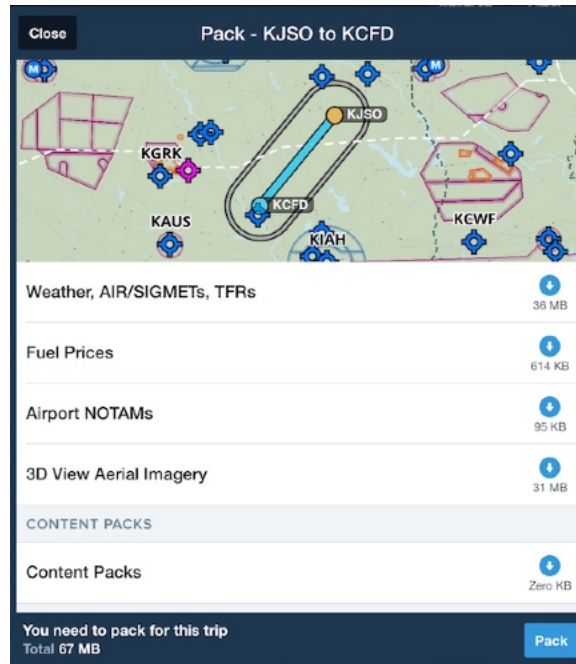

The app caches the 3D Aerial imagery for up to 20-25 airports, so the Airport 3D View for a previously-viewed (or Packed) airport may still be available while offline (eg: in-flight) even if that airport was not in the most recently-Packed route. However once the cache fills-up, the data for airport(s) that has been in the cache the longest will be cleared-out to make room for the new.

Airport 3D View is included in Performance Plus, Business Performance, and MFB Performance subscription plans.

Viewing Airport Frequencies

Airport Frequencies are shown in the first tab, broken-down by categories such as Approach, Center, Clearance, Common, etc...

For airports in the US, in support of the FAA's Clearance Relay Initiative, ForeFlight now shows the phone number and facility name for a pilot to call to obtain an IFR clearance directly from the appropriate overlying Air Route Traffic Control Center (ARTCC) or approach control facility.

When using ForeFlight Mobile on an iPhone, tap on the number to initiate a phone call to that facility.

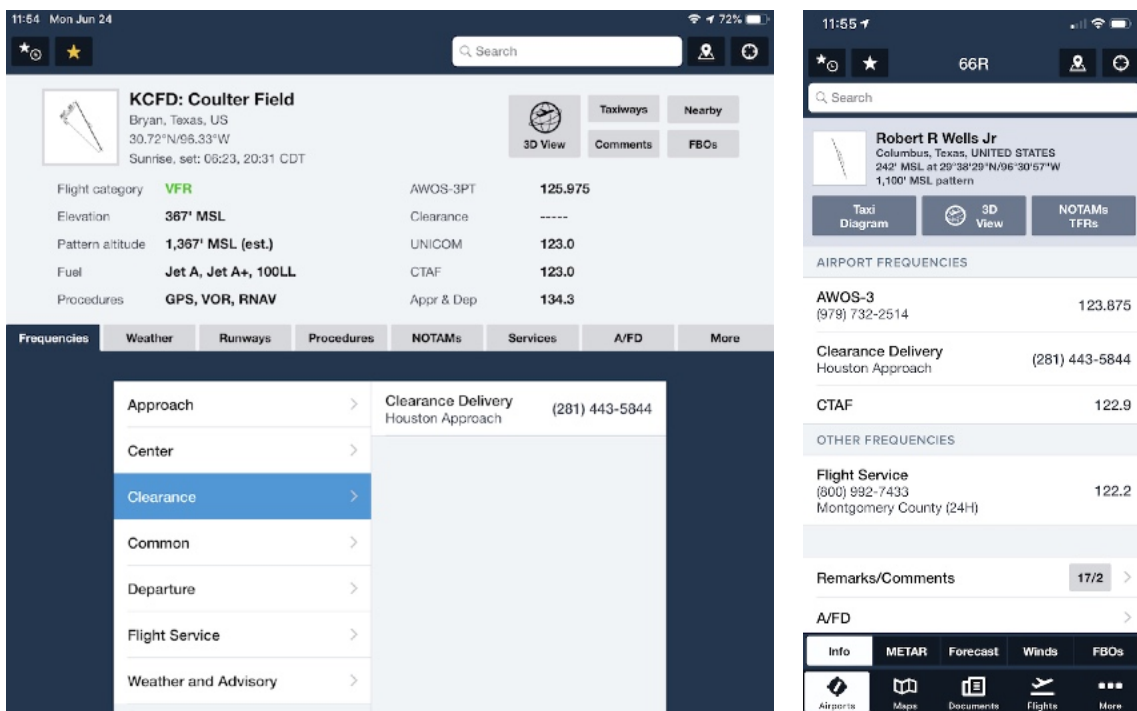

Viewing Airport Weather

Current Flight Category and a summary of weather (METAR) are shown for each airport on the [Favorite Airports](#) list. Tap the “Weather” tab to view detailed weather data for the selected airport, including METAR, TAFs, Model Output Statistics (MOS) forecasts, the Forecast Discussion for that area (US only), and Winds and Temperatures aloft with calculated difference from ISA (International Standard Atmosphere). Scroll down to see future forecasted TAFs and Winds Aloft.

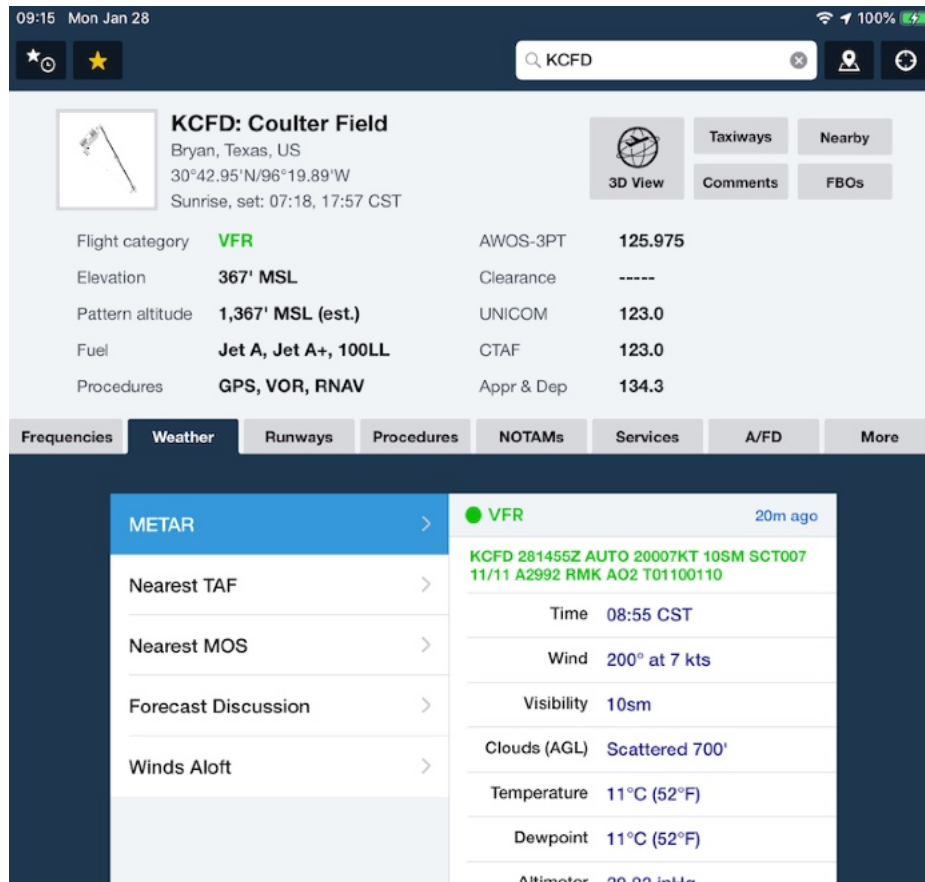

09:15 Mon Jan 28

KCFD

KCFD: Coulter Field
Bryan, Texas, US
30°42.95'N/96°19.89'W
Sunrise, sat: 07:18, 17:57 CST

3D View Taxiways Nearby Comments FBOs

Flight category	VFR	AWOS-3PT	125.975
Elevation	367' MSL	Clearance	-----
Pattern altitude	1,367' MSL (est.)	UNICOM	123.0
Fuel	Jet A, Jet A+, 100LL	CTAF	123.0
Procedures	GPS, VOR, RNAV	Appr & Dep	134.3

Frequencies Weather Runways Procedures NOTAMs Services A/FD More

METAR > **VFR** 20m ago

KCFD 281455Z AUTO 20007KT 10SM SCT007 11/11 A2992 RMK AO2 T01100110

Time 08:55 CST

Wind 200° at 7 kts

Visibility 10sm

Clouds (AGL) Scattered 700'

Temperature 11°C (52°F)

Dewpoint 11°C (52°F)

Altimeter 29.92 inHg

The forecast Temperatures Aloft at different altitudes are colored based on temperature range:

- Grey** Above +2° C
- Magenta** From +2° C down to -25° C
- Tan** Below -26° C

Digital ATIS (D-ATIS)

For Performance Plus and Business Performance customers, the latest D-ATIS is shown on the Airport Weather view and on the Maps view when viewing the Airport popup. D-ATIS requires an active Internet connection (Wi-Fi or Cellular Data).

09:15 Mon Jan 28 100%

KHOU: William P Hobby
Houston, Texas, US
29°38.73'N/95°16.74'W
Sunrise, set: 07:12, 17:55 CST

3D View Taxiways Nearby
Comments FBOs

Flight category	VFR	ATIS	124.6
Elevation	46' MSL	Clearance PDC	125.45
Pattern altitude	1,046' MSL (est.)	Ground	121.9
Fuel	Jet A+, Jet A, 100LL	Tower	118.7
Procedures	ILS, GPS, LOC, RNAV	Appr, Dep	Multiple

Frequencies
Weather
Runways
Procedures
NOTAMs
Services
A/FD
More

<p>METAR ></p> <p>D-ATIS ></p> <p>TAF ></p> <p>MOS ></p> <p>Forecast Discussion ></p> <p>Winds Aloft ></p>	<p>KHOU ATIS</p> <p>ARR/DEP F 22m ago</p> <p>KHOU ARR/DEP INFO F 1453Z. 18007KT 10SM FEW020 SCT250 13/11 A2995 (TWO NINER NINER FIVE). ILS RWY 13R APPROACH IN USE. PRIMARY DEPARTURE RWY 22. DEPARTURE RUNWAY ASSIGNED BY GRO UND CONTROL. NOTAMS... TAXIWAY K 2 CLSD. TWY C NEAR SOUTHEAST RAMP CLSD. TWY J BETWEEN RWY 4/22 AND TWY K CLOSED. ILS RWY 4GS OTS, HUB OTS. BIRD ACTIVITY VICINITY HOU APT. ALL ACFT TAXI WITH TRANSPONDER ON. ...ADVS YOU HAVE INFO F.</p>
-------------------------------------------------------------------------------------------------------------------------------------	---------------------------------------------------------------------------------------------------------------------------------------------------------------------------------------------------------------------------------------------------------------------------------------------------------------------------------------------------------------------------------------------------------------------------------------------------------------------------------------------------------------

KSEA
Seattle-Tacoma International

Direct To Add to Route Fullscreen

METAR D-ATIS

KSEA ATIS

ATIS F 64m ago

KSEA ATIS INFO F 1253Z. 14006KT 1/8SM FG VV001 07/06 A2988 (TWO NINER EIGHT EIGHT). ILS RY 16R , APCH IN USE. DEPG RWY 16C. SIMUL APCHS IN USE, BFI & SEA. TRAFFIC BELOW YOU ON FINAL. NOTAMS... RWYS 16L CLSD. TWY B CLSD BTN TWY N AND TWY G TWY H CLSD BTN RWY 16L AND TWY B, TWY K, L, M, S CLSD. BIRD ACTIVITY VICINITY ARPT. FLOW RESTRICTIONS IN EFCT FOR SFO. ...ADVS YOU HAVE INFO F.

Info METAR Forecast Winds FBOs

Model Output Statistics (MOS) Forecasts

Model Output Statistics (MOS) forecasts are derived from the output of numerical weather prediction models. An automated process developed by research meteorologists at NOAA, MOS takes the "raw" model forecast and uses a statistical approach to produce an objective site-specific forecast. For most stations, MOS forecasts are updated hourly for the first 24 hours, then updated every six hours from 25 hours to 3 days in the future. The new forecast is ordinarily available at 30 minutes past the hour.

IMPORTANT: MOS should ONLY be used as a supplemental product for enhanced situational awareness and is not meant as a substitute for official NWS forecasts.

While TAFs provide the official forecast for over 660 civilian airports throughout the US and its territories, MOS provides weather guidance for over 2000 airports including some military air bases.

KOSH: Wittman Regional
DeKalb, Wisconsin, US
43.98°N 88.06°W
Sunrise, set: 8:24 AM, 5:46 PM CST

Flight category	VFR	AIS	123.9
Elevation	808' MSL	Clearance	----
Pattern altitude	1,806' MSL	Ground	121.9
Fuel	Jet A, 100LL	Tower	118.5
Procedures	ILS, GPS, VOR, LOC, RN...	Appr & Dep	127.0

MOS 6:00 PM CST 1h 1m ago
● VFR
Winds 110° at 16 - 21 kts
Visibility more than 6sm
Clouds Sky clear
Temperature 1°C (33°F)
Dewpoint -9°C (22°F)
Expires 5:00 AM CST Tomorrow

KOSH: Wittman Regional
DeKalb, Wisconsin, US
43.98°N 88.06°W
Sunrise, set: 8:24 AM, 5:46 PM CST

Flight category	VFR	AIS	123.9
Elevation	808' MSL	Clearance	----
Pattern altitude	1,806' MSL	Ground	121.9
Fuel	Jet A, 100LL	Tower	118.5
Procedures	ILS, GPS, VOR, LOC, RN...	Appr & Dep	127.0

MOS 9:00 PM CST TOMORROW
● IFR
Winds 080° at 15 kts
Visibility 1/8sm
Clouds (AGL) Overcast 700'
Weather Mist Snow
Temperature 0°C (32°F)
Dewpoint -3°C (27°F)
Expires 3:00 PM CST Tuesday

MOS builds on the original forecast model by taking into account a historical record of observations at forecast points (such as airports), removes any known systematic model biases, and quantifies any uncertainty (like precipitation or thunderstorm chances) into probabilistic forecasts. MOS also transforms the model data into sensible weather elements basic to aviation such as sky cover, ceiling height,

visibility, wind speed and direction, the probability of precipitation, and the precipitation type. Unlike TAFs, MOS forecasts also include temperature and dewpoint when available, which can be expressed as either single values or a range of values, indicating that the value is expected to vary over the forecast period.

MOS is a point forecast similar to a TAF. That is, MOS is valid at the station (airport) and should not be used as zone or area forecast. Pilots should use MOS in a similar way they may use a TAF, keeping in mind that TAFs are constructed by highly trained meteorologists and will ordinarily be more accurate than a MOS forecast for the same airport. Although MOS cannot be used as a forecast for dispatch to the airport or for IFR alternate requirements as required by FAA regulations (use TAFs and the area forecast (FA) for this purpose) they are useful for getting a picture of likely weather at airports without a TAF, and for getting a more recently updated forecast for airports that do have a TAF, since MOS are updated hourly.

The use of "Nearest MOS" is provided strictly for convenience. Keep in mind that a MOS forecast for an airport that is 20 miles away, for example, may not be representative of the forecast for the intended airport.

Despite its advantages, the MOS has some **important limitations vs. TAFs**:

- ❖ MOS is only available for US airports and some airports in US territories.
- ❖ MOS forecasts are never amended.
- ❖ MOS does not predict temporary conditions.
- ❖ MOS cannot forecast multiple cloud layers.
- ❖ MOS does not predict specific cloud layers above 12,000' AGL.
- ❖ MOS cannot forecast precipitation intensity and cannot distinguish between rain and drizzle.
- ❖ MOS cannot distinguish between freezing rain, freezing drizzle and ice pellets. so if any is present, it just says "Freezing Precipitation."
- ❖ MOS cannot predict variable winds.
- ❖ MOS cannot forecast non-convective low level wind shear (LLWS) or no significant weather (NSW).

Runway Winds

Tap on the Runways tab to view the preferred runway based winds reported in the last METAR received by ForeFlight Mobile. Headwinds are indicated by a green arrow and tailwinds by a red arrow in the first column. The first column assumes the runway heading is straight up & down, and the direction of the arrow reflects the relative direction of the winds when flying that runway heading.

The magnitude and direction of the crosswind are shown next to the grey arrow in the middle column. The far right column shows the magnitude of headwind or tailwind.

Remember that Runway heading is listed in Magnetic, while Wind direction is True. ForeFlight automatically applies the current Magnetic Variation when calculating the wind components. You can see the Magnetic Variation on the Airports page "More" sub-tab, under Features.

In this example, the most recently received METAR for KAUS reports the winds are from 330° at 9 knots. This means that the wind on Runway 35R is a headwind from the left: the resulting left crosswind component is 4 knots and the headwind component is 8 knots.

KAUS: Austin-Bergstrom International
Austin, Texas, US
30.19°N/97.67°W
Sunrise, set: 7:16 AM, 5:30 PM CST

Flight category **VFR** ATIS 124.4
Elevation 541' MSL Clearance 125.5
Pattern altitude 1,541' MSL (est.) Ground 121.7, 121.9
Fuel Jet A, Jet A+, 100LL Tower 121.0
Procedures ILS, GPS, LOC, RNAV, RNP Appr. Dep Multiple

17L - 35R 9,000' x 150' Good concrete
17R - 35L 12,250' x 150' Good concrete

Runway	Wind Direction	Crosswind	Head/Tailwind
Rwy 17L	← 4kts	↖ 4kts	↘ 8kts
Rwy 35R	→ 4kts	↗ 4kts	↙ 8kts

Winds: 330° at 9 kts (50m ago)

Wind direction relative to runway
Green = Headwind
Red = Tailwind

Crosswind component from direction of arrow

Headwind or tailwind component on runway

Current Winds

Tap on each runway in turn to view the expected headwind and crosswind components for that runway.

Viewing a Procedure

Terminal Procedures include Standard Terminal Arrival Routes (STARs), Departure Procedures (DPs), and approach plates. These are all accessible from the *Airports* view. Use the search or browse methods of finding an airport, then tap the **Procedures** tab located on the segmented menu bar in the middle of the *Airports* view. Depending on the procedures available for this airport, several types of procedures may be displayed according to type (e.g., Arrival, Departure, Approach). Takeoff minimums and alternate minimums can be found in the Departure and Arrival tabs, respectively. Custom procedures can be added using ForeFlight Mobile's *Bring Your Own Plates* feature. For information about using BYOP, see: www.foreflight.com/support/byop

Procedures are organized by their type in order to reduce scrolling. Procedures are saved to the device in one of two ways:

❖ **Downloads View** (bulk downloading procedures): Using the *Downloads* view allows bulk downloading of procedures for one or more regions for access when offline. This is the preferred and most efficient method for ensuring you'll have the procedures you need, whether or not you're online when it's time to view them.

❖ **On-demand** (downloading procedures one at a time): If you have not previously downloaded a procedure, tap a procedure name to download it immediately. This download method requires an Internet connection and thus will be unavailable while in flight. For this reason, ForeFlight recommends either using the bulk download functionality described above, or using this on-demand method while on the ground to ensure you'll always have the procedures you need while in flight.

Procedures are marked as **Saved** or **Not Saved**. Procedures marked *Saved (in green)* are stored locally on your iPad and are available when offline. Procedures marked **Not Saved** are **NOT stored** on your iPad and must be downloaded by viewing them or by using the Downloads view to download that region's terminal procedures in bulk.

Airport >	NOT SAVED ILS or LOC Rwy 36	Map
Departure >	NOT SAVED LOC/DME BC Rwy 18	Map
Arrival >	SAVED NDB Rwy 36	Map
Approach >	SAVED RNAV (GPS) Rwy 09	Map
	SAVED RNAV (GPS) Rwy 18	Map

From the **Procedures** tab, touch a procedure's name to display the ForeFlight procedure viewer. The procedure viewer includes buttons for: accessing a list of recently viewed procedures, [sending a plate to the Map](#) (if you have a Pro, Pro Plus, or Performance Plus subscription) printing a procedure, adding a procedure to your current Plates binder, and locking the procedure.

ForeFlight Mobile's **Lock** button disables touch interaction (zooming and scrolling) with the terminal procedure viewer, which minimizes the risk of accidental closure when in turbulence. It also disables the automatic rotation that would normally occur when the iPad is turned. The lock button can also, optionally, disable all buttons on the screen, including those that change views. That feature is configured in Settings.

Multi-page procedures can be viewed by sliding pages left or right with a single finger.

To print the plate, tap the **Send To** button in the upper toolbar and choose "Printer." An AirPrint capable printer is required. For more information about this requirement, see:

support.apple.com/kb/HT4356

Tap the **Rotate** button  in the upper toolbar to rotate the plate clockwise 90 degrees per tap.

Note: Procedures are also available directly from the [Plates](#) view.

Swipe to Change Plates

When viewing a plate from the Airports page or the Plates page (including in a binder) you can quickly change between plates by **swiping three fingers** from Right to Left (or Left to Right).

When viewing plates at an Airport, swiping from Right to Left with three fingers will display the next Procedure in that airport's list and swiping from Left to Right will display the previous Procedure in that airport's list.

When viewing plates in a binder on the Plates page, swiping from Right to Left with three fingers will display the next Procedure in the binder and swiping from Left to Right will display the previous Procedure in the binder.

In either case the lists do not "wrap around" so when you get to the end of the list, additional swipes in the same direction will not take you to the end (or beginning) of the list or binder.

IMPORTANT: The “Zoom” Accessibility option (in Apple Settings, General, Accessibility) must be OFF for plate swiping to work. If the “Zoom” Accessibility feature is ON, swiping with three fingers will not change between plates.

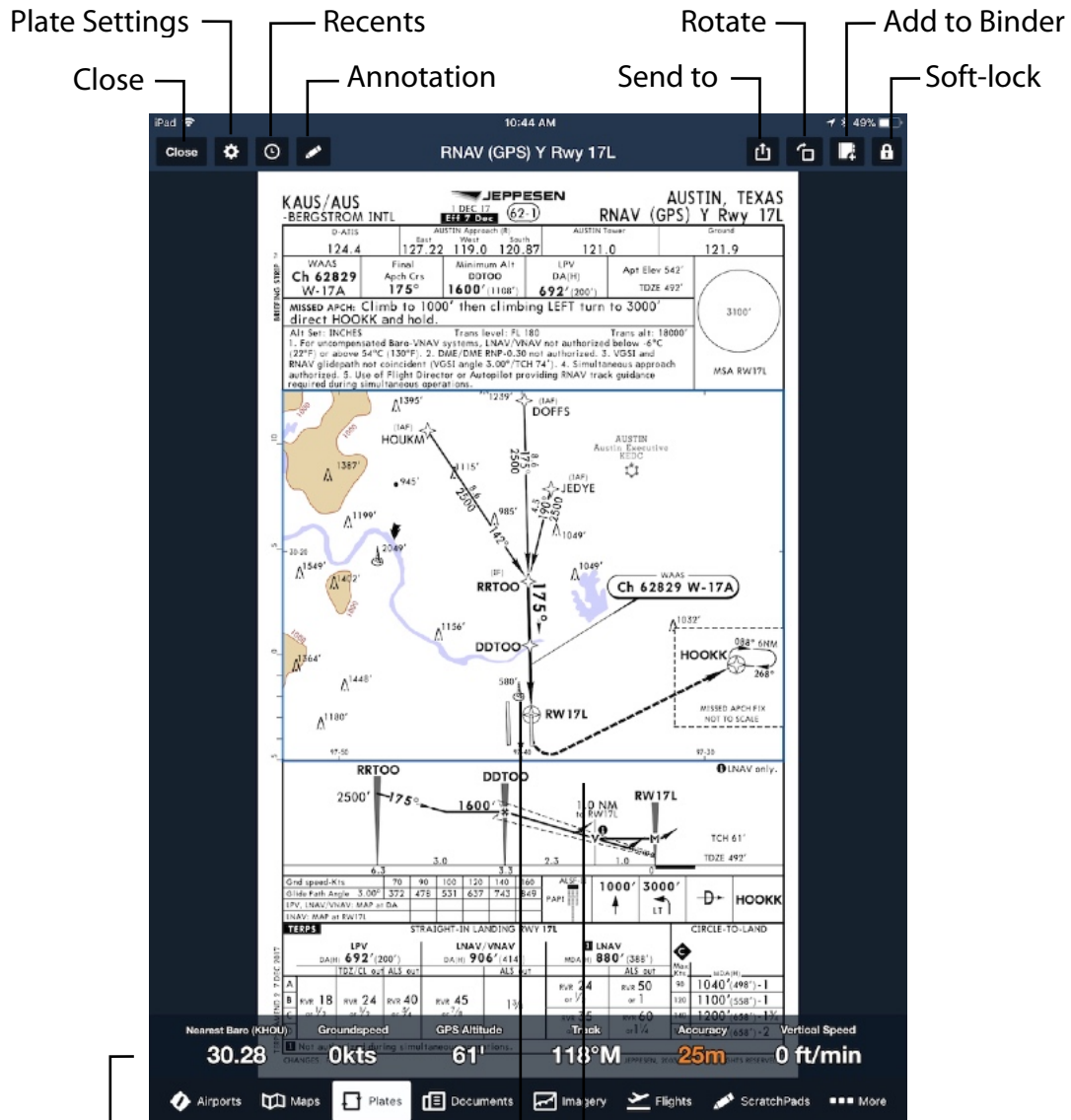

Instrument Panel
Tap to hide/show Instrument Panel & menu
Touch-hold, then release to show Annotation menu, or tap Annotation button in Menu bar

NOTE: Displaying the Instrument Panel and aircraft position on a Plate requires a ForeFlight Pro, Pro Plus or Performance Plus subscription. Basic Plus subscriptions do not show the Instrument Panel on the Plates page.

Using Geo-Referenced Procedures

Geo-referencing is an optional feature that requires a ForeFlight Pro, Pro Plus, or Performance Plus subscription. Go to www.foreflight.com/buy or the Accounts view to learn how to purchase or upgrade your subscription.

Most instrument procedures can be geo-referenced. This allows ForeFlight Mobile to display the aircraft's position on the procedure.

Only approach plates and taxi diagrams are geo-referenced; STARs/DPs are not drawn to scale and so cannot be geo-referenced. But using the "Procedure" button on the Flight Plan Editor you can add the points on the SID/STAR to your route.

When a geo-referenced FAA procedure is displayed, a blue square is drawn around the geo-referenced area (this is not the case with geo-referenced Jeppesen procedures). This is the only area of the plate in which your aircraft will be shown. Note that some plates are only drawn to-scale in the center portion - if your aircraft's location is shown outside that area it is positioned based on the scale of the center area and must *only* be compared to elements within that center area.

Until GPS data senses movement and provides a track over the ground, position is indicated using a small blue dot. Once your aircraft starts moving, the aircraft icon selected in ForeFlight Mobile settings is shown. Much like the *Maps* view, the aircraft speed, track, etc. is displayed at the bottom of the view. Tap an item in the Instrument Panel to change it. Geo-referenced approach plates and taxi diagrams can now also be displayed on the Map page, see the [Plates on a Map](#) section.

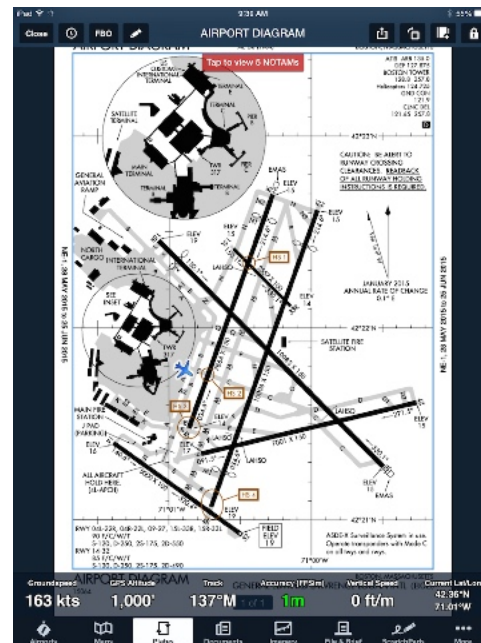

Airport NOTAMs

Tap the NOTAMs tab to view all the NOTAMs that have been issued for that airport. ForeFlight divides NOTAMs according to their type, with sub-tabs for Airport, Obstacle, TFR, and ARTCC NOTAMs. If you've purchased or linked [Jeppesen chart coverages](#) in ForeFlight, a "Jeppesen" tab is also available with NOTAMs for that airport issued by Jeppesen.

If any runway or airport closure NOTAMs are in effect for an airport, ForeFlight will display a prominent red banner across the Airports view to let you know about it. Tap the NOTAM banner to directly view the NOTAMs.

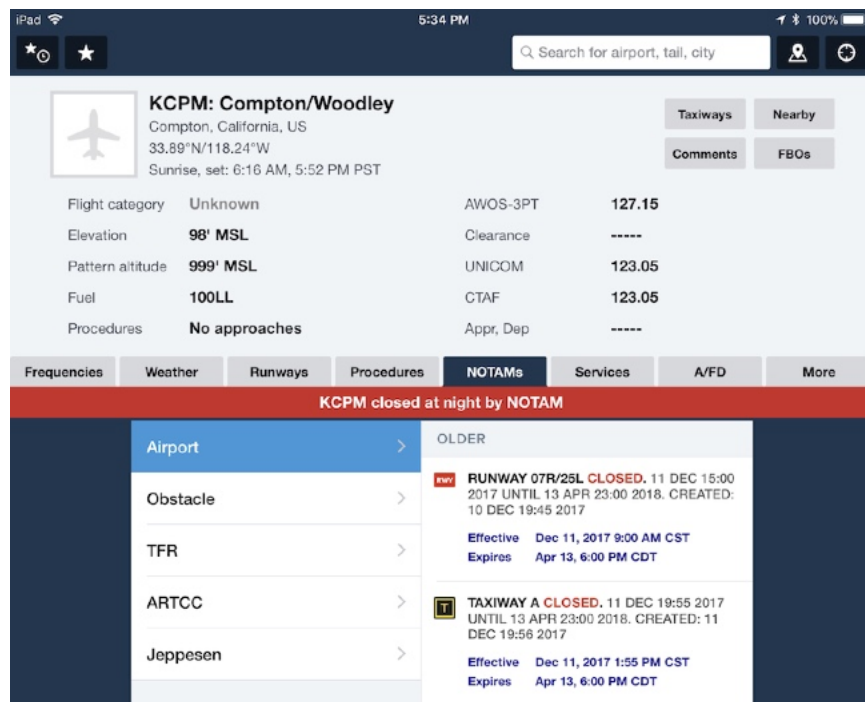

For runway closure NOTAMs, the banner includes the name of the closed runway, and a red "Closed" label is also added on the Runways tab. Tap the closed runway to see the relevant NOTAM.

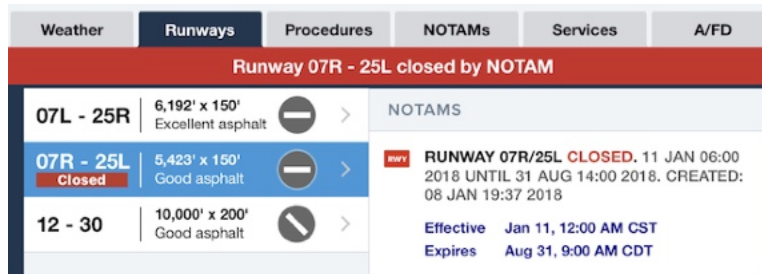

FBO Information

To access a list of Fixed Based Operators providing pilot services at an airport, tap the **FBOs** button. FBO details displayed include hours of operation, fuel prices, location on field, fuel availability, comments, contact numbers and frequencies, and any additional services provided. ForeFlight includes FBO details for thousands of airports worldwide.

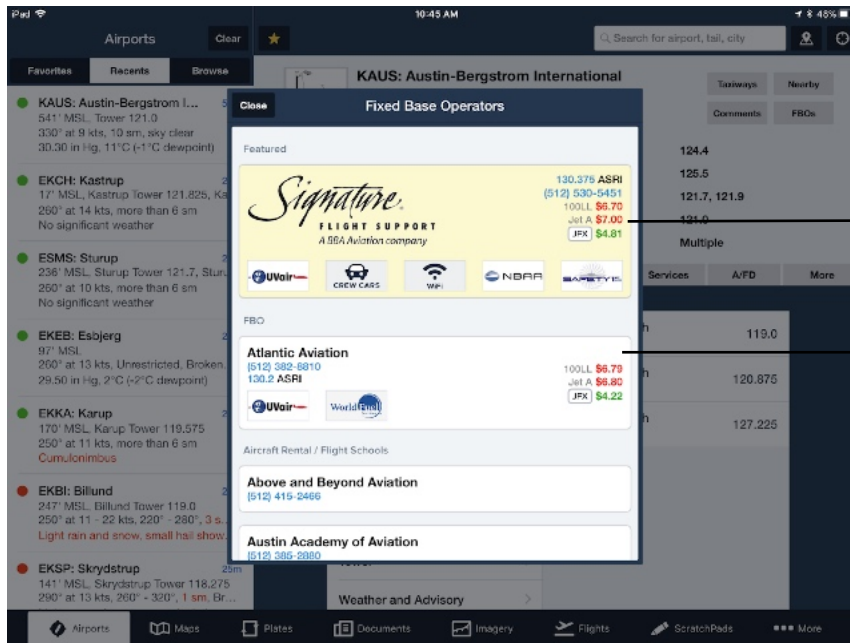

Tap FBO or Service boxes for more detailed information or to update fuel prices

The [location of FBOs](#) that sell fuel can also be shown directly on the Airport Diagram.

FBO information can also be accessed on the Maps page by tapping on an airport icon and choosing the FBOs button in the bottom-right of the popup. When you tap on an FBO's entry, the popup shows details of that FBO including icons for calling the FBO, getting directions (using Apple Maps), and emailing the FBO.

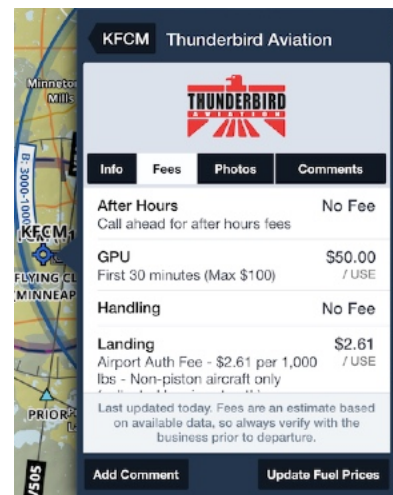

Comments

User-provided comments are available for FBOs and airports. View FBO comments by tapping the Comments tab just above the fuel price information. Once you access comments, they are saved to your device so you'll be able to view them again later - even when you are offline.

To add a comment, tap the "Add Comment" button. Comments are moderated by ForeFlight and will appear for all users to see after they are reviewed.

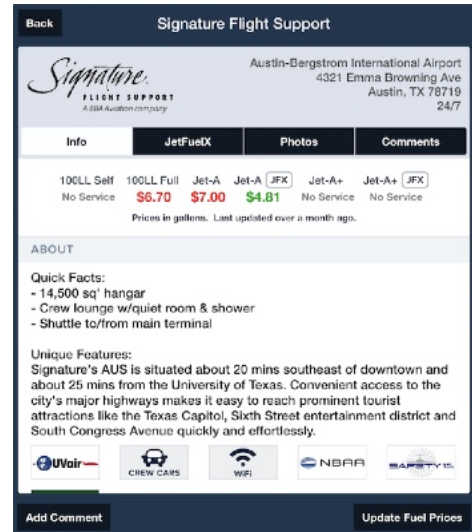

Fuel prices

Fuel price data is provided for thousands of FBOs. This price data is not guaranteed, so it is important to verify the price information with the FBO when complete accuracy is required. The price data does not differentiate between cash or credit pricing, nor will it reflect any discounts that may be available.

Tap the "Update Fuel Prices" button when viewing an FBO's details to submit updated fuel prices. When submitting price data, leave unknown prices blank. Blank values will be ignored when the prices are updated on the ForeFlight system.

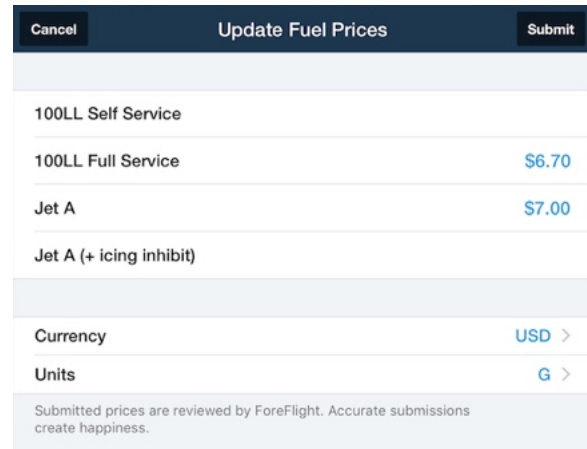

Airport/Facility Directory (A/FD), Canada Flight Supplement (CFS), or Aeronautical Information Publication (AIP)

For additional airport information like pilot-controlled lighting procedures, parachute jumping activities, etc., sometimes there's just no better place than a good old-fashioned Airport/Facility Directory, Canada Flight Supplement (for Canadian airports) or Aeronautical Information Publication (for European and other airports around the world).

Frequencies
Weather
Runways
Procedures
NOTAMS
Services
A/FD
More

232
TEXAS

AUSTIN

AUSTIN EXECUTIVE (EDC)(KEDC) 12 NE UTC-6(-5DT) N30°23.85' W97°33.98'

620 B NOTAM FILE EDC

RWY 13-31: H6025X100 (ASPH) D-101 MIRL 0.4% up NW

RWY 13: REIL. PAPI(P4L)—GA 3.0° TCH 40'. Thld dsplcd 600'. Tree.

RWY 31: REIL. PAPI(P4L)—GA 3.0° TCH 40'.

RWY 16-34: H1550X25 (ASPH) S-8 1.0% up N

SERVICE: S4 FUEL 100LL, JET A LGT ACTIVATE MIRL Rwy 13-31, REIL Rwy 13 and Rwy 31—CTAF. PAPI Rwy 13 and Rwy 31 opr continuously.

AIRPORT REMARKS: Attended continuously. Fuel avbl 24 hrs with credit card. Acft tiedowns and buildings within Rwy 16-34 primary sfc. Rwy 16-34 twy unmarked. Rwy 13-31 twy edges are marked by reflector posts. Northwest end of Rwy 13-31 and parallel twy have a 16' descending embankment off end of pavement. Touch and go landings prohibited. VFR departures requesting ATC svc remain clear of the final apch course of Rwy 17L and Rwy 17R. If the acft is initially eastbound, ctc Austin Apch Ctl on 127.22. If the acft is initially westbound ctc Austin Apch Ctl on 125.32. Austin clearance delivery 126.025

AIRPORT MANAGER: 512-247-7678

WEATHER DATA SOURCES: AWOS-3 118.825 (512) 616-2967.

COMMUNICATIONS: CTAF/UNICOM 122.975

Ⓜ **AUSTIN APP/DEP CON** 127.225 **CLNC DEL** 126.025

RADIO AIDS TO NAVIGATION: NOTAM FILE AUS.

CENTEX (H) VORTAC 112.8 CWK Chan 75 N30°22.71' W97°31.79' 295° 2.2 NM to fld. 593/6E.

COMM/NAV/WEATHER REMARKS: For Clnc Del ctc AUS Apch at 512-369-7865.

SAN ANTONIO
H-7C, L-19C, 21A
IAP

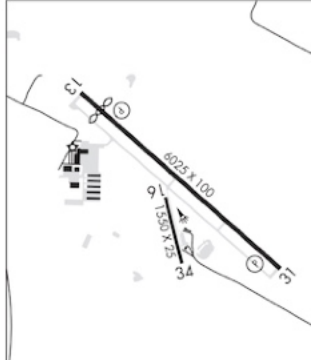

AUSTIN-BERGSTROM INTL (AUS)(KAUS) P (ARNG) 5 SE UTC-6(-5DT) N30°11.67' W97°40.19'

542 B LRA Class I, ARFF Index D NOTAM FILE AUS

RWY 17R-35L: H12250X150 (CONC-GRVD) S-75, D-210, 2S-175, 2D-618, 2D/2D2-913 PCN 98 R/B/W/T HIRL

RWY 17R: MALS. PAPI(P4L)—GA 3.0° TCH 60'. RVR-TR Rgt ttc. 0.6% down.

RWY 35L: MALS. PAPI(P4L)—GA 3.0° TCH 60'. RVR-TR Rgt ttc. 0.3% up.

SAN ANTONIO
H-7C, L-19C, 21A
IAP, AD



1 of 2

Airports
 Maps
 Plates
 Documents
 Imagery
 Flights
 ScratchPads
 More

Each airport's A/FD entry is available from the A/FD (or CFS, or AIP) tab - just as you'd see it in the familiar green-covered printed version. If the entry has multiple pages you can single-finger swipe to the left or right to change pages. A single-tap on the A/FD page will display the "1 of n" at the bottom of the page, where n is the number of pages relating to that airport.

Airport and Aircraft Flight Tracking

Flight tracking data is provided by FlightAware.com, and is available only while connected to the Internet. On the Airports page, tap on the **More** tab then choose **Flight Tracking**. Tap Scheduled Arrivals, Scheduled Departures or Enroute to open Safari and show a list of aircraft scheduled to arrive or depart, or that are enroute to the airport.

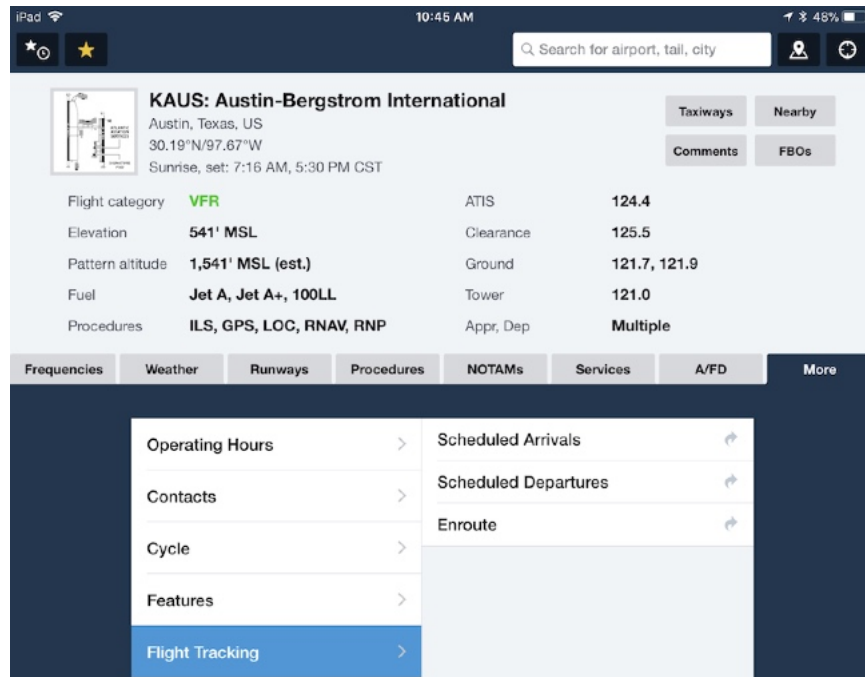

To track an individual aircraft, type an aircraft Tail-number in the Search box, then tap the "Track" button in the aircraft registration information popup.

Maps

About the Design

The Maps view is the place to visualize airspace, weather, terrain and other factors that may affect your route. The maps view is also the place to chart your progress during a flight. The maps themselves take center stage with supporting data surrounding them.

The screenshot shows the ForeFlight Mobile v12.0 interface in the Maps view. The top bar includes 'Aero & TFRs', 'FPL', and various icons. A search box is located in the top right. Below the top bar is a flight plan table with columns for FROM, TO, HDG, TOTALS, LEG, REMAINING, and ETA(CTD). The main map area displays a flight route with various waypoints and altitudes. A bottom status bar shows flight data such as Distance to Next, GPS Altitude, ETE Next, Course Next, Track, Groundspeed, Accuracy, and Descent to Dest. The bottom navigation bar includes icons for Airports, Maps, Plates, Documents, Imagery, Flights, ScratchPads, and More.

Labels and callouts in the image include:

- Hide/Show Flight Plan (! indicates Pack needed before flight)
- Favorites/Recents
- Map Settings
- Search box
- Layer Selector
- Synthetic Vision
- Show/Hide Instrument Panel
- Auto-center
- Show/Hide:
 - Airports
 - Airspace
 - Airways
 - FIR/UIR
 - Terrain
 - Roads/RR
 - Annotate
 - Track Log
 - Record
 - Zoom to
 - Route
 - Zoom In or Out
- Instrument Panel
- Route line (future legs)
- Radar / Satellite Animation
- Route line (active leg)
- Annotation
- Route line (past legs)
- Edit, NavLog, Profile, 3D

Pinch, Zoom, and Pan

Each map in the Maps view supports the standard iPad gestures for zooming and panning. Drag your finger on the map to slide it to a new region. Use two fingers in a pinch or expand gesture to change the zoom scale of the map. You can also double tap the map to zoom in one level or tap once with two fingers at the same time to zoom out one level. Anytime you display a new route on the map the zoom level and region shown will auto-adjust to bring your route into view.

Tap the Zoom to Route button in the lower left of the Maps screen to automatically zoom the map in or out to show the entire Route.



Map Annotations

Map Annotations allow you to write and draw directly on the Maps view for easier note-taking on the fly.

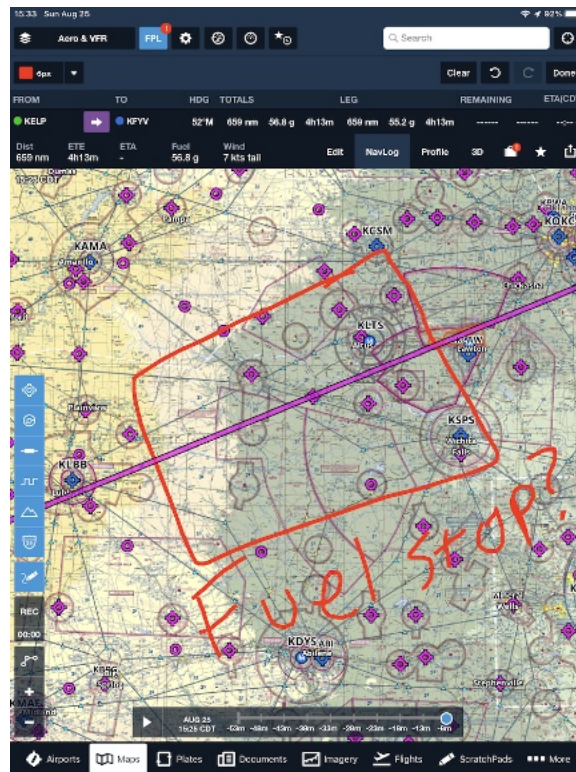

Tap the Annotation button  on the left sidebar to enter Drawing Mode and use one finger to draw, and use two fingers to move the map without adding new annotations.

Map Annotations remain on the map until cleared, and automatically scale as you zoom out and in.



To clear Map Annotations, tap the Annotations button:



then tap the “Clear”

button at the right of the top Annotation menu to clear ALL annotations off the map, or tap Undo or Redo to remove or re-add the latest annotations.

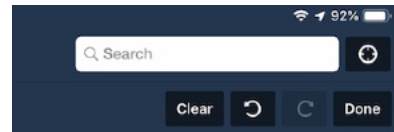

To change line options, tap the drop-down at the left of the top Annotations menu. There you can choose line color, opacity, and thickness:

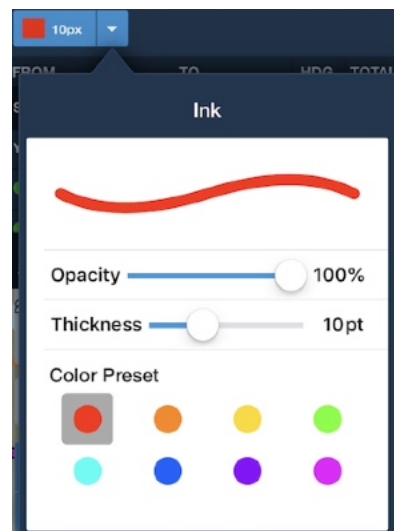

If your iPad supports the Apple Pencil, quickly add Map Annotations by touching your Apple Pencil to your iPad’s screen, while normal touch gestures still allow you to pan, zoom, or tap on map objects. Auto Apple Pencil Drawing mode will automatically exit after 10 seconds without input.

Enable the Auto Apple Pencil Drawing setting and change or disable the Drawing Mode Reset time in More > Settings.

Changing Maps / Map Layers

A variety of chart and map types are available. To change which map is displayed, tap the Layer Selector in the top-left. Tap a chart or map name to display it. Beginning with version 11.9, the drop-down now allows you to toggle multiple map layers in a row without having to reopen the Layer Selector each time, by enabling the new “[Multiple Selections](#)” setting at the bottom of the Map Settings menu. Once enabled, the Layer Selector remains open until you tap elsewhere on the screen so you can quickly toggle as many layers as you want. And on the Pad you can also now pan and zoom around the map while the layer selector is open, even if the Multiple Selections setting is disabled.

The chart types shown in the layer selector are based on the regions included in your subscription plan (U.S., Canada, and/or Europe), your selections in [Download Settings](#), and any Jeppesen chart coverages that you have purchased or linked to your account.

Each chart is geo-referenced and seamless, meaning that you can view your current location on the map and do not need to change maps to view a new region - simply drag with your finger to move the map.

Weather data can be overlaid on any chart selection (such as VFR charts). Additionally, any marker or shape layer can be selected for viewing. Examples of these are TFRs or Visibility. Only one marker-type can be selected at once. To de-select a layer and hide it, tap it in the layer selector.

Chart Types:

- ❖ **ForeFlight Map** - The permanent, customizable base map that all other maps and layers are overlaid on, which shows political boundaries and geographic features. See [Maps Settings](#) for more information.
- ❖ **Aeronautical** - ForeFlight’s Global Aeronautical Map. This displays Jeppesen-sourced aeronautical data, such as airports, airspace, VORs, waypoints, FIR (Flight

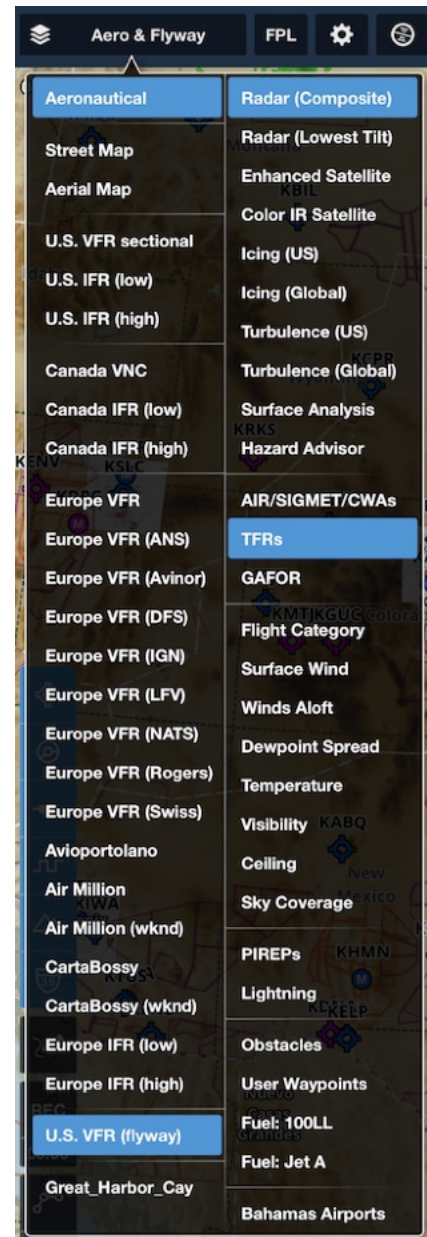

Information Region) or UIR (Upper Information Region) boundaries, and more. See [Global Aeronautical Map](#) for more information.

❖ **Jeppesen Enroute Charts** - Global set of VFR, IFR Low, and IFR High enroute charts. Available for anyone who purchases or links a Jeppesen chart coverage in ForeFlight. See [Using Jeppesen Enroute Charts in ForeFlight](#) for more information.

❖ **Street Map** - Detailed street map. This map can only be used when connected to the Internet. However, views you display while connected to the Internet are cached in memory and may be available in-flight, provided the cache is not cleared or filled to capacity.

❖ **Aerial Map** - Satellite image map including street labels. This map can only be used when connected to the Internet. However, views you display while connected to the Internet are cached in memory and may be available in-flight, provided the cache is not cleared or filled to capacity.

❖ **U.S. VFR Sectional** - Terminal Area Charts (TACs) are automatically displayed when a VFR sectional is zoomed in to major cities containing a TAC inset.

❖ **U.S. IFR** - low or high IFR enroute charts from FAA.

❖ **Canada VNC** - VFR Terminal Area Charts (VTAs) are automatically displayed when a VNC is zoomed in to major cities containing a VTA inset.

❖ **Canada IFR** - low or high IFR enroute charts from NavCanada.

❖ **Europe VFR** - visual navigation charts from European national AIP providers (e.g. DFS for Germany), available as optional add-ons to the Europe region.

❖ **Europe IFR** - low or high IFR enroute charts via EUROCONTROL.

❖ **U.S. IFR (planning)** - IFR planning chart covering contiguous 48 states.

❖ **U.S. IFR (ocean)** - Atlantic and Pacific ocean IFR charts.

❖ **U.S. VFR (flyway)** - VFR planning charts (from the “back” of the TAC charts). Also available in the FAA Drive in Documents.

❖ **Carib/Mexico IFR** - IFR Low or High charts covering Mexico and the Caribbean. Tap **More > Downloads > Canada, Mexico, Central America**, then turn **IFR Low Charts** and/or **IFR High Charts** to **ON**.

❖ **U.S. Helicopter** - Three-color charts showing aeronautical information useful to helicopter pilots navigating in 9 major metro areas with heavy helicopter activity. Includes helicopter routes, heliports, nav aids and obstructions. Can be selected with any U.S. base map.

❖ **Heli Gulf VFR** - U.S. VFR Sectional-style chart of the Gulf of Mexico (GOM) showing airspace, GOM blocks, airspace, and oil rig and weather station locations. Can be selected with any U.S. base map.

❖ **Heli Gulf IFR** - IFR style chart of the Gulf of Mexico (GOM) showing GOM blocks, GPS waypoints, airspace and weather station locations. Can be selected with any U.S. base map.

❖ **Custom Charts** - display a custom .mbtiles chart on the map. Multiple Custom charts can be imported and displayed at a time. See the [Custom Content](#) section for details about creating the files and importing them into the app.

Map Layers:

Refer to the [Weather Legends](#) chapter near the bottom of this document or the dedicated **Legends in ForeFlight Mobile** guide to find legends for many of the following map layers.

Map layers IMPORTANT NOTICE:

An active Internet connection or in-flight weather receiver such as a Sentry ADS-B or SiriusXM SXAR1 are required to display timely map layer information.

Immediately before your flight: While still connected to the Internet, use the [Pack](#) feature to ensure all relevant TFR and weather data is downloaded. Note the time-stamp in the upper-left corner of the Maps page, indicating the time when the layer's data was received.

❖ **Radar (Composite)** - Radar for the US and Canada showing a composite of multiple angles of radar scan.

❖ **Radar (Lowest Tilt)** - Radar for the US and Canada showing only the lowest angle (tilt) radar scan, useful for determining where precipitation is actually reaching the ground.

You can animate the radar layers using the [Time Slider](#). The radar layers check for updates every three minutes. For more details, see the [Radar Legend](#), and radar color vs. intensity legends for [Rain](#), [Mixed Rain/Snow](#), and [Snow](#).

Radar requires an active Internet connection, or ADS-B "In" receiver (Composite only), or SiriusXM in-flight weather receiver (Composite and Lowest Tilt). Selecting Radar in-flight without one of these will display diagonal hashmarks with the message "Radar not Available" across the Map. Clear the hashmarks and message by de-selecting the Radar layer using the Maps drop-down.

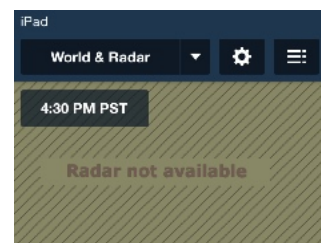

Beginning with ForeFlight Mobile 11.10, the limits of Internet Radar coverage can now be shown with “Radar not available” and grey ////-marks across the screen (similar to when viewing Radar via ADS-B or XM). The display updates dynamically to reflect radar provider outages, and can be selected ON or OFF in [Maps Settings](#).

Examples of Radar coverage areas for North America, Europe, and Japan and Australia, are shown below:

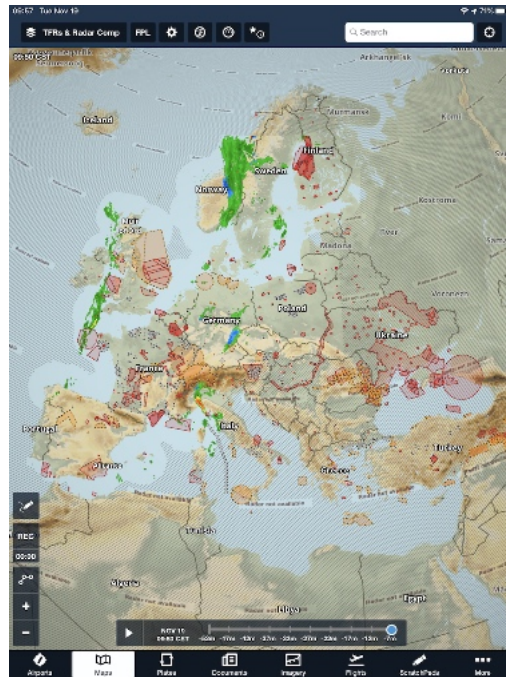

❖ **Echo Tops (SXM) (requires GDL 51, GDL 52, or SXAR1)** - Displays the height where ground-based radar detects reflectivities above 18 dBZ. Use the altitude slider on the right to filter out echo tops at lower altitudes. Covers CONUS plus northern Mexico and southern Canada.

❖ **Cloud Tops (SXM) (requires GDL 51, GDL 52, or SXAR1)** - Displays cloud top height derived from satellite temperature sensors. Use the altitude slider on the right to filter out cloud tops at lower altitudes. Covers CONUS plus northern Mexico and southern Canada.

❖ **Cloud Tops (ADS-B) (requires ADS-B receiver)** - Displays cloud top height derived from satellite temperature sensors. Use the altitude slider on the right to filter out cloud tops at lower altitudes.

❖ **Enhanced Satellite** - Visible- or infrared-derived (depending on time of day) grayscale satellite with color infrared highlights for high-altitude cloud tops.

❖ **Color IR Satellite** - Infrared satellite colorized to depict the temperature of the cloud tops. Ground temperature depictions are masked out to show regions without clouds. Color-temperature scale is the same as used in the [Infrared Satellite imagery](#).

You can animate the satellite layers using the [Time Slider](#). The satellite layers check for updates every three minutes, but new images are typically transmitted every 30 minutes.

Satellite requires an active Internet connection or Baron Mobile Link weather receiver (IR Satellite is not available with Baron Mobile Link). The Satellite layer is not available with an ADS-B or SiriusXM weather receiver.

❖ **Icing (SXM) (requires GDL 51, GDL 52, or SXAR1)** - Displays icing severity levels (light, moderate, heavy), plus SLD threat. Use the altitude slider on the right to view icing severity at different altitudes. Covers CONUS plus northern Mexico and southern Canada generally between 16N and 59N Latitude.

❖ **Icing (US)** - Displays icing severity forecasts (light, moderate, heavy). Use the [Time Slider](#) to view different frames in the forecast, and use the altitude slider to view icing severity at different altitude. Covers CONUS plus northern Mexico and southern Canada generally between 16N and 59N Latitude. Requires an Pro Plus, Performance Plus, or Business Performance subscription.

❖ **Icing (Global)** - Displays icing severity forecasts (light, moderate, heavy). Use the [Time Slider](#) to view different frames in the forecast, and use the altitude slider to view icing severity at different altitude. Provides worldwide coverage. Requires an Pro Plus, Performance Plus, or Business Performance subscription.

- ❖ **Turbulence (SXM) (requires GDL 51, GDL 52, or SXAR1)** - Displays turbulence intensity forecast based on a **medium** aircraft weight category. Use the altitude slider on the right to view turbulence intensity forecasts at different altitudes. Covers CONUS plus northern Mexico and southern Canada.
- ❖ **Turbulence (ADS-b) (requires ADS-B receiver)** - Displays turbulence intensity forecast based on a **medium** aircraft weight category. Use the altitude slider on the right to view turbulence intensity forecasts at different altitudes.
- ❖ **Turbulence (US)** - Displays EDR (eddy dissipation rate) forecasts which translate into turbulence severity based on aircraft weight. Use the [Time Slider](#) to view different frames in the forecast, and use the altitude slider on the right to view EDR forecasts at different altitudes. Covers CONUS plus northern Mexico and southern Canada generally between 16N and 59N Latitude. Requires an Pro Plus, Performance Plus, or Business Performance subscription.
- ❖ **Turbulence (Global)** - Displays EDR (eddy dissipation rate) forecasts which translate into turbulence severity based on aircraft weight. Use the [Time Slider](#) to view different frames in the forecast, and use the altitude slider on the right to view EDR forecasts at different altitudes. Provides worldwide coverage. Requires a Pro Plus, Performance Plus, or Business Performance subscription.
- ❖ **Sfc Analysis (SXM) (requires GDL 51, GDL 52, or SXAR1)** - Displays isobars, pressure readings, and other weather features associated with a surface analysis product. Covers almost all of North and Central America (excluding northernmost Canada and Alaska) and as far west as Hawaii.
- ❖ **Surface Analysis** - Displays isobars, pressure readings, and other weather features associated with a surface analysis product. Use the [Time Slider](#) to view different frames in the forecast. Provides global isobar and pressure readings and more detailed weather features for North America. Requires an Pro Plus, Performance Plus, or Business Performance subscription.
- ❖ **Freezing Levels (requires GDL 51, GDL 52, or SXAR1)** - Displays freezing level boundaries in 1,000 foot intervals using a colorful overlay. Covers CONUS plus northern Mexico and southern Canada.
- ❖ **Hazard Advisor** - Terrain-based map, colored red or yellow based on terrain height relative to aircraft position (yellow for terrain between 1,000' and 100' below the aircraft, red for higher terrain). Also shows obstacles in local area within 1,000' of aircraft altitude. Requires a Pro Plus, Performance Plus, Business Pro, or Business Plus subscription plan.

❖ **Search & Rescue Grids:** *These map layers are available when Search and Rescue is enabled in Settings. For more details see the Search and Rescue Supplement in Documents > Drive > ForeFlight:*

❖ **CAP Grid** - “Conventional” 15-minute quadrangle grid squares, in the format ORD385.

❖ **Cell CAP Grid** - “new” grid based on 1 degree of latitude/longitude, in the format 40092AA.

❖ **GARS Grid** - Grid Area Reference System made up of 30-minute cells with 15-minute quadrants and 5-minute areas, in the format 175LX.

❖ **Traffic (requires ADS-B)** - When connected to an ADS-B receiver, the Traffic option is shown. When selected, ADS-B traffic is displayed on the map. **TRAFFIC DISPLAY WILL BE LIMITED UNLESS YOUR AIRCRAFT IS EQUIPPED WITH ADS-B OUT. SEE [ADS-B TRAFFIC SECTION](#) FOR MORE DETAILS.**

❖ **TFRs** - covers regions provided by FAA as well as 3rd party sources (Stadium TFRs), and **in Europe: Graphical NOTAMs**. Tap a TFR shape to see more details. TFR shapes are shown in **Yellow** until 8 hours before the scheduled start time. Within 8 hours of the TFR being active, it is shown in **Red** until the end of the TFR.

TFRs IMPORTANT NOTICE:

Graphical TFR information is ONLY updated and displayed if you select the TFR Map layer while connected to the Internet, or while using an in-flight weather receiver.

However if the FAA publishes a TFR without associated graphical shape information it may not be possible for ForeFlight Mobile to show the graphical TFR on the Maps page.

Therefore you should also check the Airports page, under NOTAMs > TFRs for airports along your route, and contact FSS or ATC to confirm that your route does not cross any such TFRs

Immediately before your flight: While still connected to the Internet, use the [Pack](#) feature to ensure all relevant TFR and weather data is downloaded. TFRs issued **after** you Pack will not be shown, unless you are using an ADS-B or XM in-flight weather receiver.

For limitations when using a Sentry or other ADS-B receiver or XM weather receiver, please see the [ADS-B Weather](#) or [XM Weather chapters](#).

Graphical NOTAMS (Europe)

Graphical NOTAMs in Europe are available for most of Europe and Turkey. NOTAMs are color-coded based on type and severity, with airspace and obstacle notices in **Gray**, scheduled exercises in **Orange**, and restricted/danger areas in **Red**. Where possible the NOTAM's exact shape is displayed.

Graphical NOTAMs are automatically downloaded when you pack for a flight so you can access them without an internet connection.

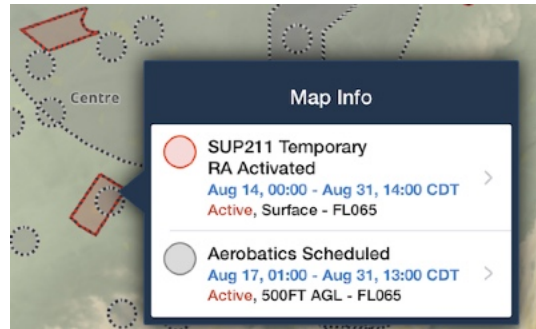

❖ **AIR/SIGMET/CWAs** - covers regions provided by FAA, as well as international SIGMETs. The shapes are colored-coded based on type:

Blue for freezing level and icing conditions.

Orange for turbulence and high winds.

Purple for IFR.

Pink for mountain obscuration.

Yellow for convective outlooks.

Red for SIGMETs of all types.

Center Weather Advisories receive the same color as their underlying report (eg: Purple for IFR, etc...)

These types can be selectively filtered from the map using the four buttons that appear at the bottom of the screen when the layer is selected.

Tap an AIR/SIGMET/CWA shape to display a popup listing all advisories at that location, then tap on one to see full details about the advisory, including the highlighted lateral boundary (thick red border in the image at right); this is especially useful when multiple *METs overlap in one place.

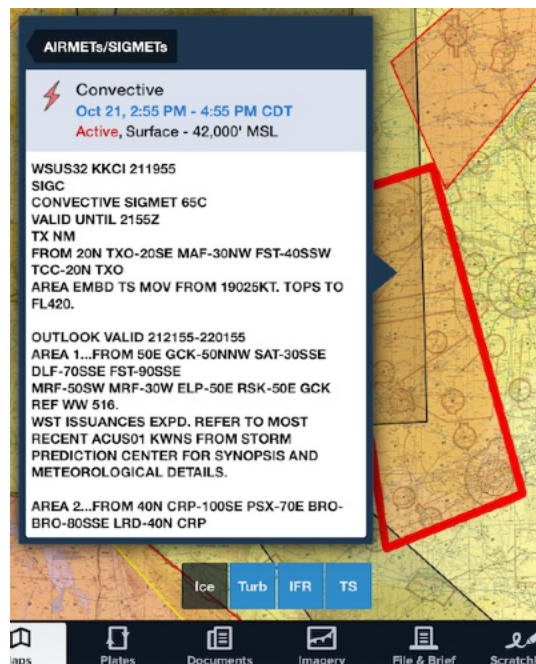

❖ **GAFOR (Europe only)** - The General Aviation Forecasts layer displays color-coded GAFOR indexes in regions for France and Germany, and GAFOR routes for Switzerland, Austria, Slovenia, and Croatia.

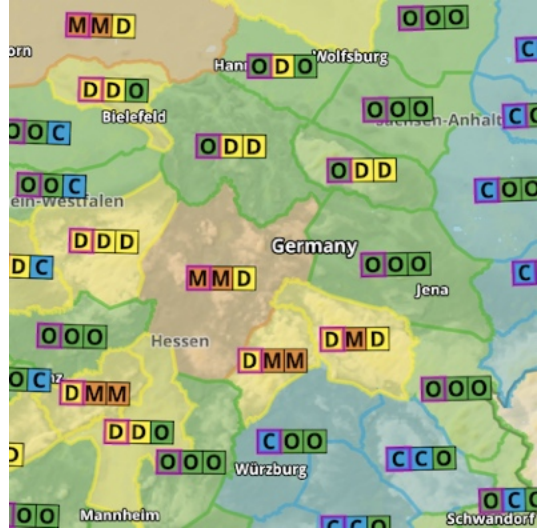

GAFOR is updated multiple times per day, but is not available later at night (typically between 0000Z-0300Z). During this time selecting the layer will display hashmarks and "Data not available."

Tap on a GAFOR icon to see the Index, time periods, and additional weather information: the reference altitude for that region or route, the cloud base height in feet, and the visibility in kilometers

The GAFOR Indexes are:

C - Clear: Visibility greater than 10km and cloud bases higher 5,000ft - Used only in Germany

O - Open: Visibility greater than 8km and cloud bases higher than 2,000ft.

D - Difficult: Visibility greater than 5km and cloud bases higher than 1,000ft

M - Marginal: Visibility greater than 1.5km and cloud bases higher than 500ft

X - Closed: Any visibility with cloud bases lower than 500ft or any cloud base with visibility less then 1.5km

/ - Data Unavailable.

DE43 Nordhessisches Bergland und Vogelsberg	
Reference Altitude	2000
19:00 - 22:00 (JUL 18, 2019)	
GAFOR Index	Unavailable
Cloud Base	Unavailable
Visibility	Unavailable
22:00 - 00:00 (JUL 18, 2019)	
GAFOR Index	Marginal
Cloud Base	500'+
Visibility	1.5km+
Weather Notes	Isolated Rain Showers
00:00 - 02:00 (JUL 19, 2019)	
GAFOR Index	Marginal

❖ **Weather Layers** - a variety of weather measurements can be displayed on the map: Flight Category, Winds Aloft, Dewpoint Spread, Temperature, Visibility, Surface Wind, Ceiling, Sky Coverage, PIREPs, and Lightning. The weather layers are updated every five minutes when connected to the Internet. See [Weather Layer Color Coding](#) for details of color coding for each type of layer.

❖ **Winds Aloft** - Forecasted Winds Aloft, up to 6 hours ahead. To adjust the altitude of the displayed forecasted winds, tap-hold on the altitude slider and move it up or down until your desired altitude is shown, or tap on the bar above or below the slider to move the slider by one increment in either direction. You can select altitudes from 3000' to FL540 in 3000' increments.

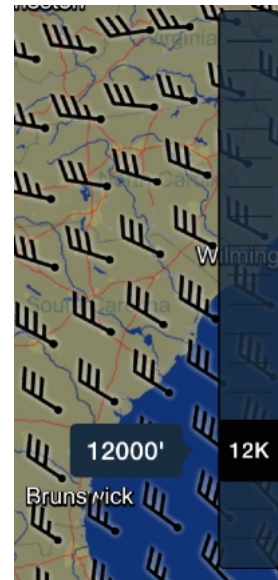
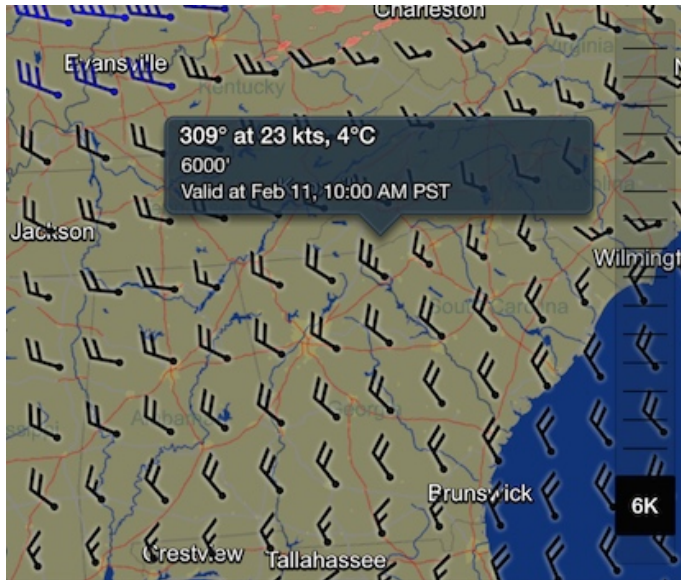

Tap a winds barb to see the forecasted wind speed, direction and temperature at that altitude, and the “Valid at” time for that forecast.

❖ **Surface Winds** - derived from METARs at Airports, shows wind speed and direction at those locations only. *See below for side-by-side comparison.*

❖ **Surface Wind Analysis (requires GDL 51, GDL 52, or SXAR1)** - generated from an automated forecast model, shows forecast wind speed and direction at tens of thousands of evenly spaced points across the country. Good for viewing low-level circulations across a wide area.



Surface Winds



Sfc Wind Analysis

❖ **Obstacles** - shows obstacle markers based on the FAA’s USA data.

❖ **User Waypoints** - all User Waypoints view are shown on the Map.

❖ **Fuel prices** - prices for 100LL or JetA fuel. Fuel prices are color coded by price in the region where the airport is located - less expensive prices are in green,

average in orange, most expensive in red. When searching for the best prices, **Zoom-in** to display more vendors' prices in a given area.

❖ **Custom Map Layers** - display a custom KML or KMZ file on the Map. Multiple KML and KMZ files can be displayed at a time. See the [Custom Map Layers](#) section for details about creating the files and importing them into the app.

NOTE: The Radar layer requires an Internet, ADS-B, or XM WX (SiriuXM SXAR1 or Baron Mobile Link) connection. The Satellite layer requires an Internet or XM WX (Baron Mobile Link only) connection. Weather layers require an Internet connection. Fuel price layers require an Internet connection the first time they are used. The **Downloads** view can be used to download Obstacles as well as World, IFR, and VFR charts for use when offline.

Weather Layer Time Slider

When you select a time- or forecast-based weather layer like radar, satellite, or the icing/turbulence/surface analysis layers, a time slider tool appears at the bottom of the screen. Tap the play button on the left to animate the layer; this advances the time slider frame-by-frame, while the timestamp on the left shows the date and time when each frame was valid. Forecast-based weather layers use a vertical white bar on the time slider to indicate the present time.

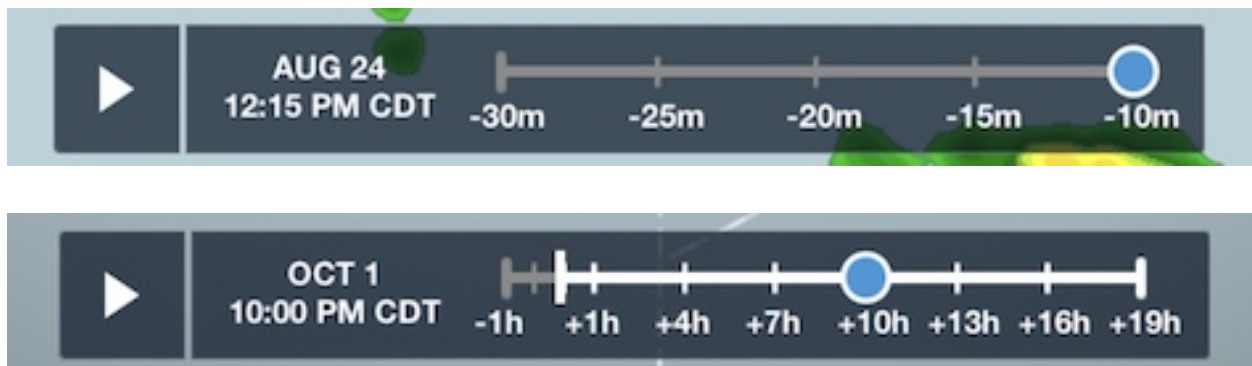

You can manually control the animation by tap-holding on the time slider and dragging it left or right to view different frames, or by tapping on the line to the left or right of the slider to advance it one frame at a time in either direction.

Map Info pop-up for Overlapping Map Layers

In areas where multiple map layers overlap, a single tap now brings up a “Map Info” pop-up with details about each item in that area. Tap one of the items from the list to view additional information.

In this example, the AIR/SIGMET/CWAs layer is selected at the same time as the TFR layer. Tapping in the area around the TFR shows the Map Info pop-up with options for the nearby Airway, the TFR, and the SIGMET.

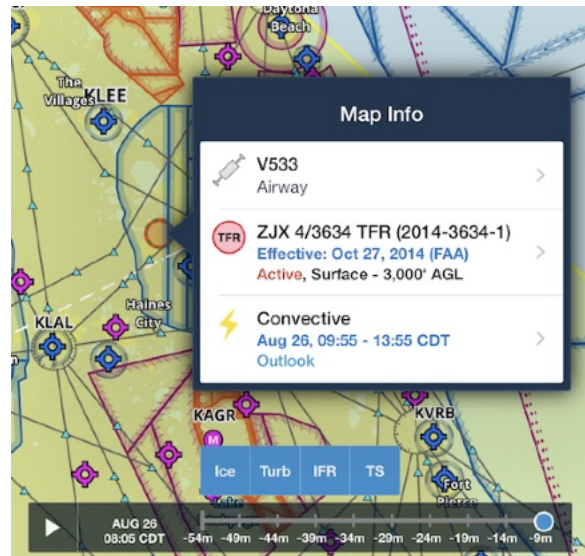

3D View Anywhere

The 3D View can now be accessed anywhere on Earth. With a Performance Plus or Business Performance subscription, touch-hold on the map then tap the “3D” button in the top right of the Add to Route pop-up to see a realistic view of that location, combining high-resolution terrain and aerial imagery.

NOTE: An internet connection is required to view the 3D View Anywhere, and the aerial imagery is not saved when you Pack a route before a flight.

Use one finger to pan/tilt the view, and use two fingers to pinch-zoom the view. The compass circle in the lower left shows your orientation (North is up).

To change positions, close the 3D View, then touch-hold on a different part of the map and tap the “3D” button to re-open the view there.



Global Aeronautical Map

ForeFlight Global Aeronautical Map utilizes a new kind of mapping technology which uses sets of digital aeronautical data to display information on the map. This differs from traditional VFR and IFR charts which are digital image files of charts, also known as “raster” charts. Building a map or chart layer using pure digital data allows information to be manipulated and displayed in many useful and powerful ways.

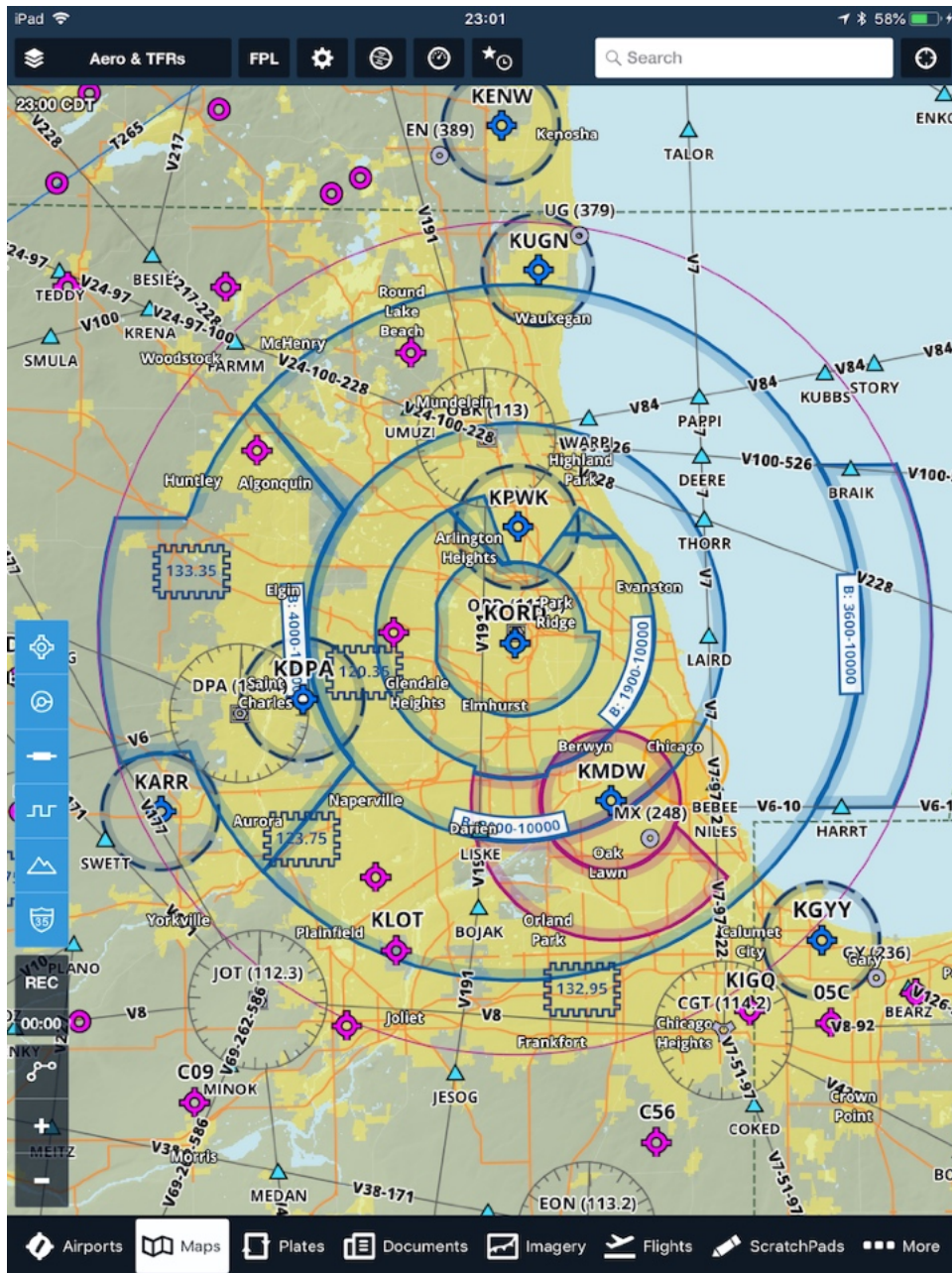

The data used in the Aeronautical Map come primarily from Jeppesen, as well as the FAA, Nav Canada, Eurocontrol, and other official sources. Updates are delivered as part of the Airport and Nav Database updates, which are delivered every 28 days, or more often as needed.

The Aeronautical Map is available with ForeFlight “Plus” subscription plans, and are also available as an add-on for other plans.

When viewing the Aeronautical data by itself, use [Maps Settings](#) to switch between “Light” and “Dark” Map Theme, as well as between “Shaded” and “Colored” terrain.

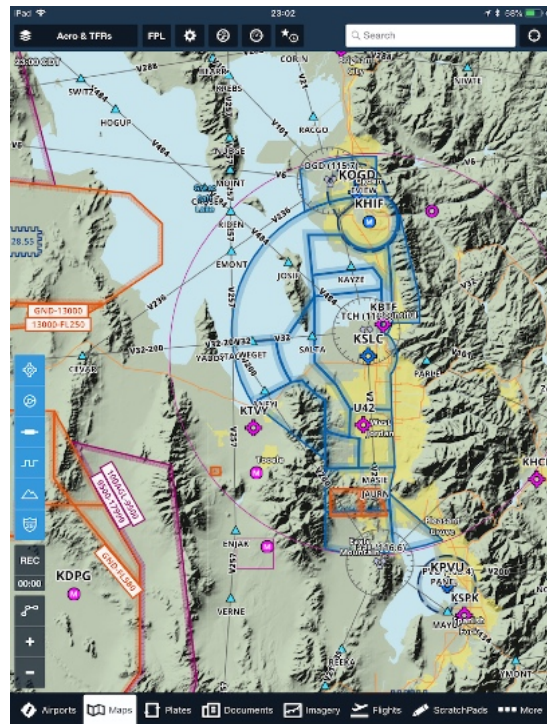
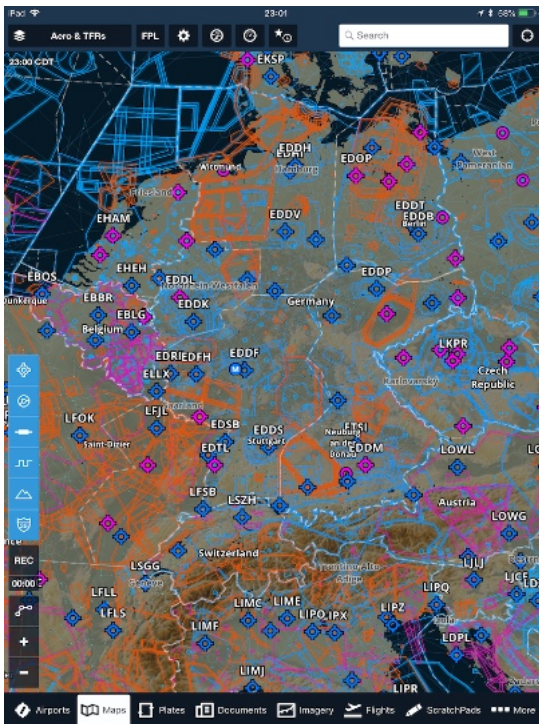

The Aeronautical data can also be overlaid over any available chart or map type.

Aeronautical Map Features

❖ **Continuous Zoom** - Icons, shapes, and text labels smoothly fade in and out as the zoom level changes, in contrast to raster charts which have to re-render at certain zoom levels to maintain their clarity.

❖ **Decluttering** - The information shown on the map changes along with the zoom level, with large-scale features like ARTCC boundaries and major airports appearing when zoomed out, and small-scale features like waypoints, VORs, and smaller airports appearing as you zoom in. This prevents the map from becoming too cluttered with information, and ensures that the most relevant information at any zoom level is shown.

❖ **Automatic Airspace Highlighting** - Automatically highlights airspace within an altitude of +/- 1,000' and a 1-nautical mile corridor of your planned route of flight, and dims all other airspace to reduce clutter. Your aircraft's climb, cruise, and descent trajectory is considered when determining which airspace to highlight. In-flight, airspace ahead of your current track is highlighted.

❖ **Always-Up Labels** - Labels for airports, waypoints, and other map features always appear in the proper orientation, even when the rest of the map is upside down, as when flying south in "Track Up" mode.

❖ **Customizable Data** - The data shown on the map can be customized to the type of planning or flying you're doing. Airspaces can be turned on or off, airways can be set to either high or low IFR, and ARTCC borders, heliports, and private airports can be toggled on or off. See [Maps Settings](#) for more information.

❖ **Adjustable Text Size** - The text size of labels for every map element can be adjusted using a slider. See [Maps Settings](#) for more information.

❖ **Single Tap** - When the Aeronautical layer is enabled, tapping on the icon for any map item will open that item's detail view, allowing you to bypass the tap-hold action and "Add to Route" popup that is normally required to see details about a map item.

❖ **Embedded Airport Diagrams** - ForeFlight airport diagrams are directly integrated with the Aeronautical Map, fading in as you zoom into an airport. The diagrams include labels for runways, taxiways, hold pads, and FBOs.

Airspace Label Style

The Worldwide Altitudes switch in [Maps Settings > Airspace](#) changes the Aeronautical Map airspace labels to a “tag” style label that is attached to airspace boundaries. The “tag” includes both the airspace type, as well as the airspace’s altitudes. The “tags” for relevant airspace automatically reposition to remain in view as you pan/zoom around the map.

This setting defaults ON and applies worldwide. The Worldwide Altitudes setting must be ON to show airspace altitudes in Europe, however pilots in the U.S. can switch back to the traditional “Sectional” style of airspace label by turning the switch OFF.

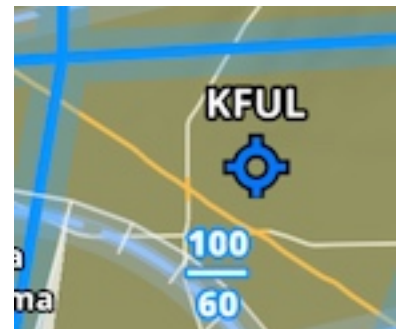

Worldwide Altitudes ON



Worldwide Altitudes OFF
(U.S. Sectional style)

Aeronautical Map Filters

A column of toggle buttons (iPad only) allows you to quickly turn on and off different Aeronautical Map features. The buttons show only when the Aeronautical Map layer is on. The buttons allow you to Show/Hide:

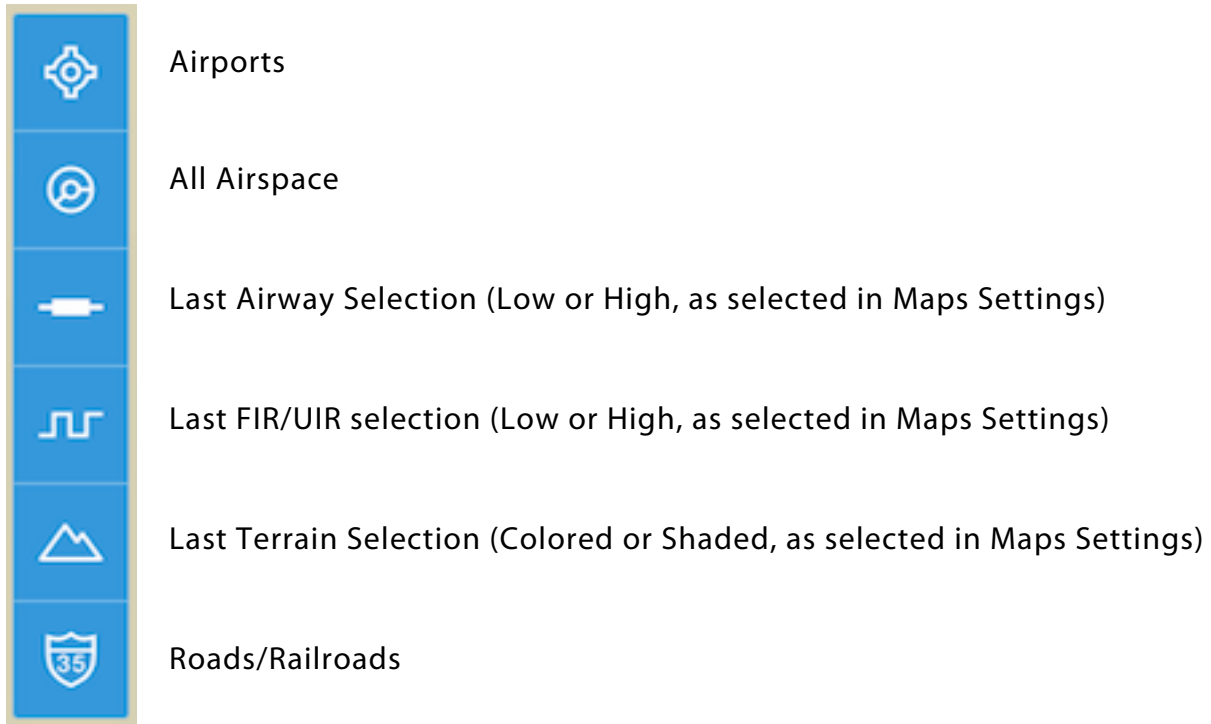

Examples:

USA





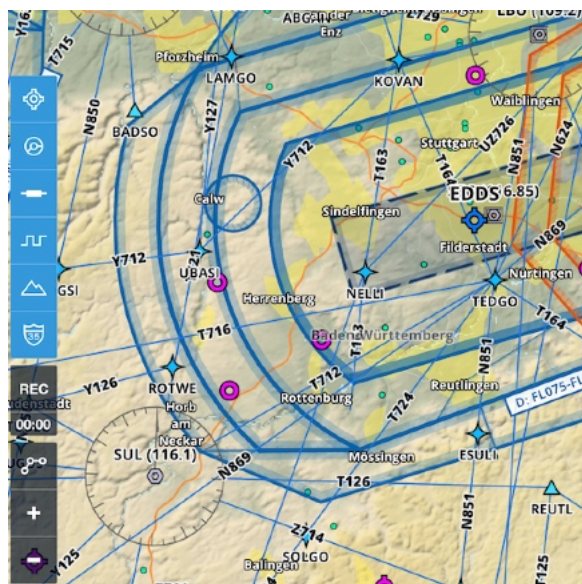





























Europe





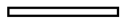



Aeronautical Map Symbols

The following symbols are shown on the Aeronautical Map layer:

	Civil Airports with Services (with and without tower)		Civil Airports without Services (with and without tower)
	Military Airports (with and without tower)		Private Airports (with and without tower)
	Seaplane Bases with Services (w/ and w/o tower)		Seaplane Bases without Services (w/ and w/o tower)
	Heliports (light map color scheme)		Heliports (dark map color scheme)
	Standard fix		RNAV fix
	Standard fix (Compulsory)		RNAV Fix (Compulsory)
	VOR Navaid		VOR/DME Navaid
	VORTAC Navaid		NDB Navaid
	NDB/DME Navaid		FBO Location (on ForeFlight airport diagram)
	ARTCC Boundary		ADIZ
	Class B/TMA/CTA Airspace		Class B Altitude (USA)
	Class C Airspace		Class C Altitude (USA)
	Class D Airspace		Class D Altitude (USA)
	Class E to Surface (USA)		Mode C (USA)
	TRSA (USA)		SATR Area (USA)
	CTR		MOA/Alert/Training Airspace
	RMZ		ATZ/TIZ/TIA
	MATZ		TSA/TRA

	Caution/Warning/Danger Airspace		Prohibited/Restricted Airspace
	Other Airspace		VOR Airways/Jetways
	RNAV Routes		FIS Boundary
	ARTCC Sector Stamps		Global Airspace Altitude Labels
	Helipad		
			Airway ID (MEA)
			Airway ID (MEA / Heading based on route)
VFR (Europe only)			
	VFR Waypoint		VFR Waypoint (Compulsory)
	VFR Helicopter Waypoint		VFR Helicopter Waypoint (Compulsory)
	Landmarks		HIRTA (High Intensity Radio Transmission Area)
	Low Point		Bird Refuge
	Model Flights		VFR Arrival
	VFR Departure		VFR Arrival & Departure
	VFR Flight Corridors		IFR Flight Corridors
	Helicopter Procedure		VFR Transit Route
	Traffic Circuit (Non- standard aircraft)		Traffic Circuit
	Directional Traffic Circuit (Non-standard aircraft)		Directional Traffic Circuit
	Nature Area		No Overfly Area

	Fuel		Parking
	Tower		Cashier
	Beacon		Tower (Lit)
	Windsock		

European Airspace

With a Europe subscription, ForeFlight global Aeronautical Map includes Jeppesen's European VFR navigation and airport data in addition to IFR data, supporting both VFR and IFR flying in Europe.

Data includes VFR Waypoints (Standard and Helicopter),
VFR Procedures including Entries & Exits, Traffic Circuits, Holds,
No Overfly Areas, Nature Areas, Bird Sanctuaries,
and Model Flight Areas.

These examples show how the airspace is depicted at various levels of zoom, all the way down to the Airport level showing the location of Parking, Fuel, and the Cashier.

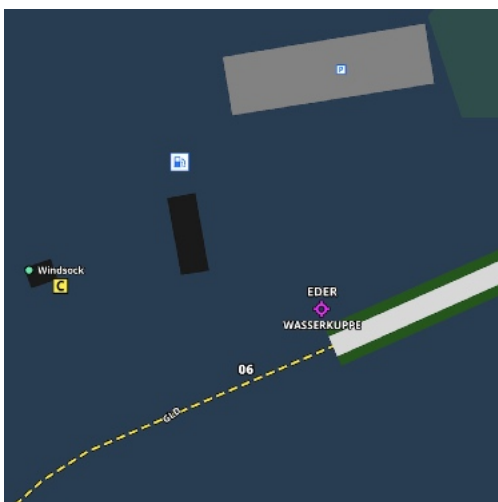
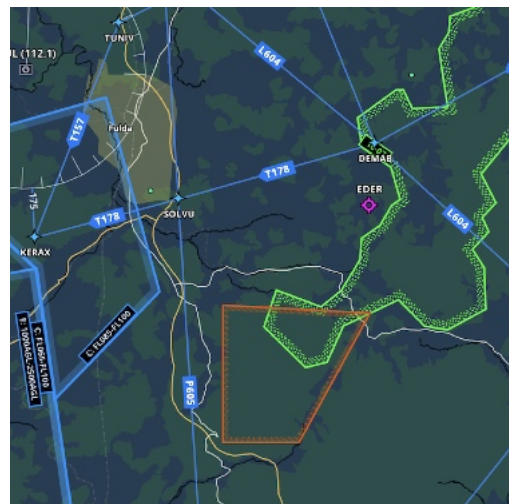

Automatic Airspace Highlighting

Automatic Airspace Highlighting (requires iOS 11 or later) highlights airspace that the planned route will intersect based on the selected aircraft's climb, cruise, and descent profile, or current in-flight track.

Airspace within an altitude of +/- 1,000' of the planned altitude and within a 1-nautical mile corridor of your planned route of flight is highlighted, while other airspace along the route is visible but dimmed to reduce clutter.

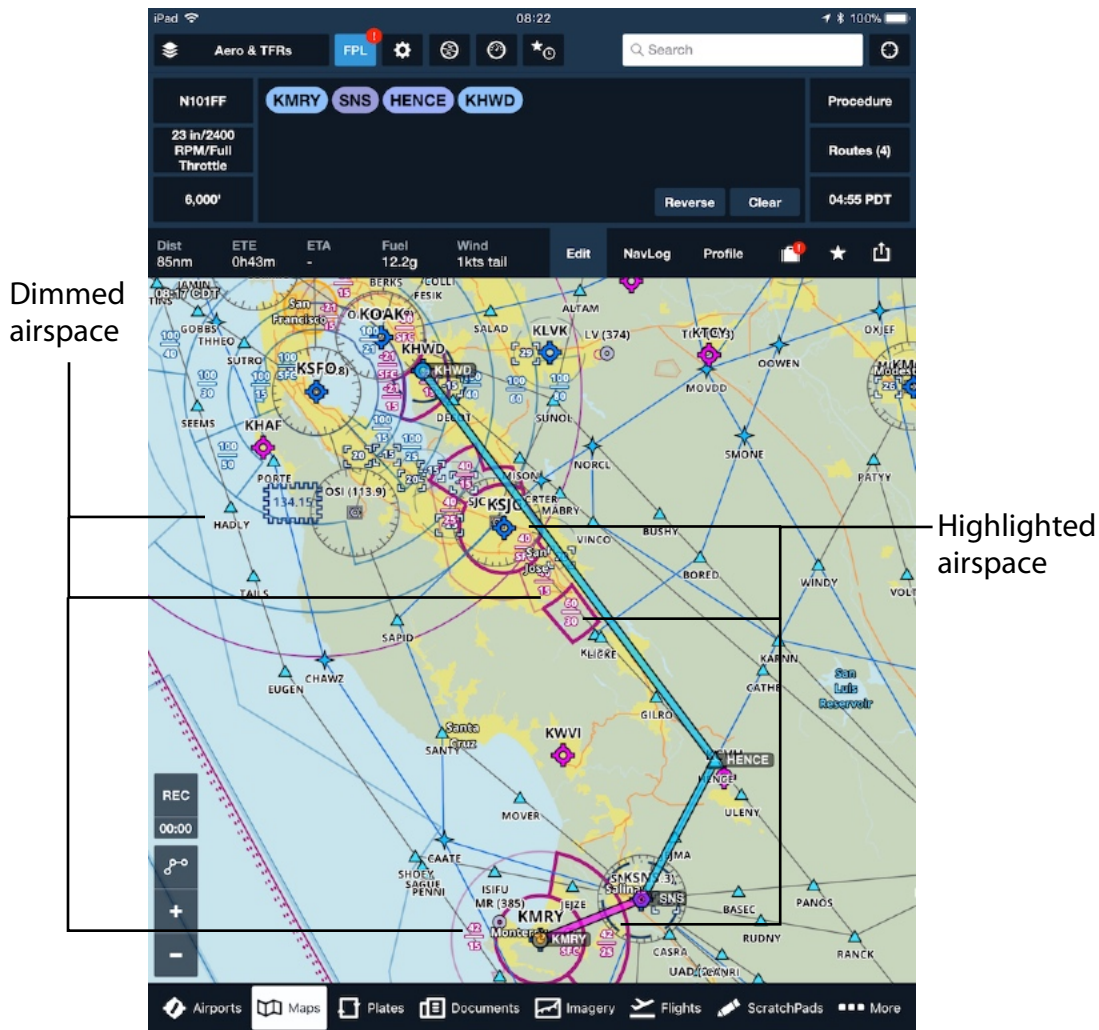

In-flight, airspace up to 50nm ahead of the current track (also within +/- 1,000' of current altitude and within a 1-nautical mile corridor) is highlighted.

Note in the first picture that the HOOD MOA that lies along the aircraft's current track is highlighted. Once the aircraft turns on course, the HOOD MOA is no longer

highlighted, but the GRAY MOA is still highlighted because it is within 1nm of the current track.

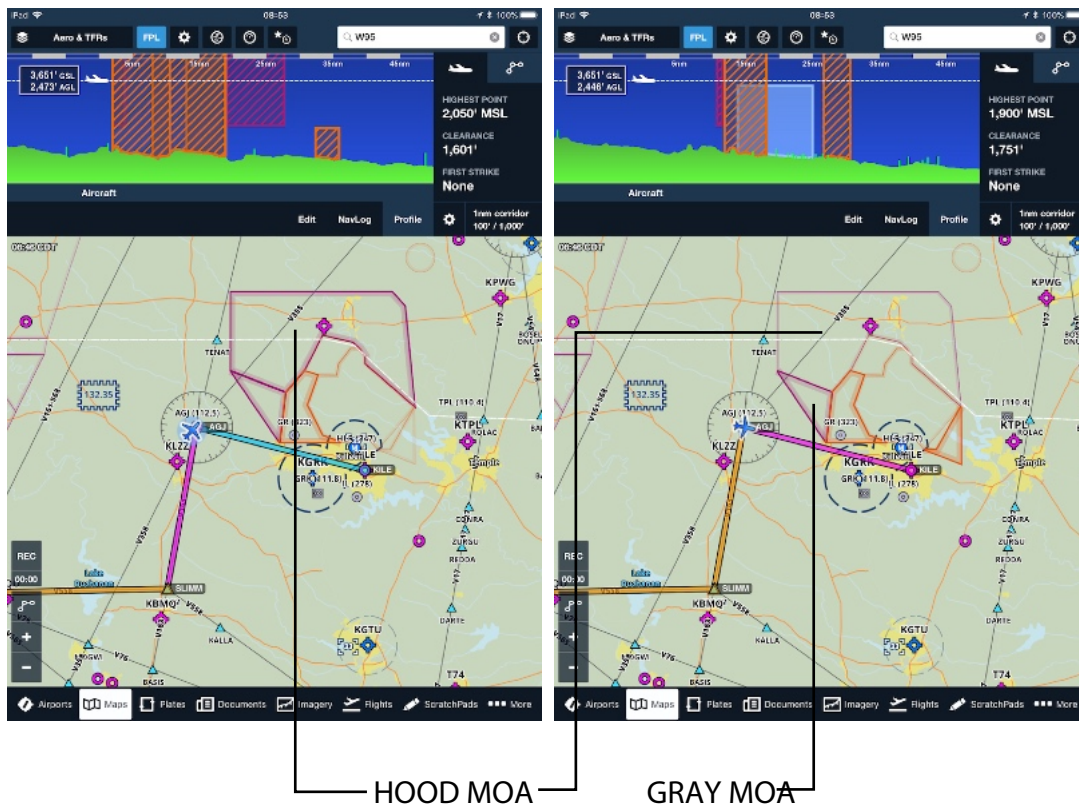

Hide Airspace by Altitude

With the Aeronautical layer selected, tap the Maps Settings (gear) button, then tap Airspace to select whether airspace above a certain altitude (in Feet) is hidden. Values of 500 or more are treated as Feet; values from 5-499 are treated as Flight Level (FL). So 65 is expanded to 6500; 320 is expanded to 32000.

If you climb to within 1,000 feet of hidden airspace along your route, the hidden airspace will automatically be displayed.

The Hide Airspace Above value is also shown in a reminder box in the lower-right of the Maps page.

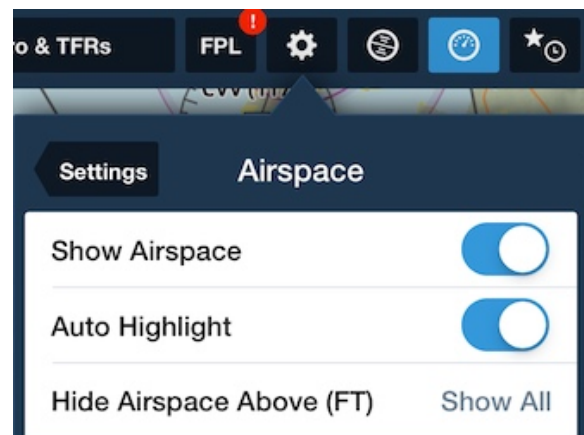

Hiding Airspace Above 15,000' >

Organized Track Systems

ForeFlight Mobile 10.2 and later (requires Performance Plus or Business Performance plan) includes the option of displaying Organized Track Systems (OTS) for North Atlantic, North Pacific, and Australasia.

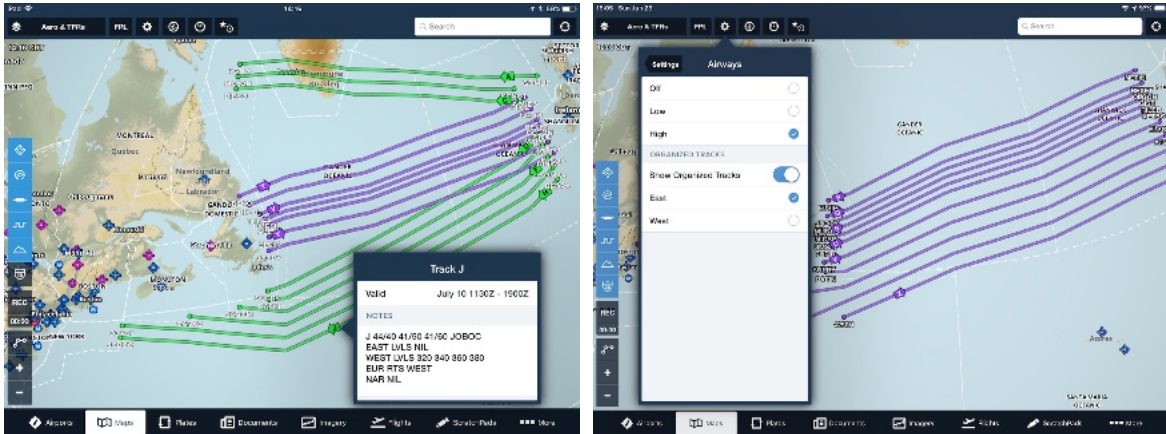

Tracks are updated automatically, and tapping on a track shows additional details such as valid times and controller notes.

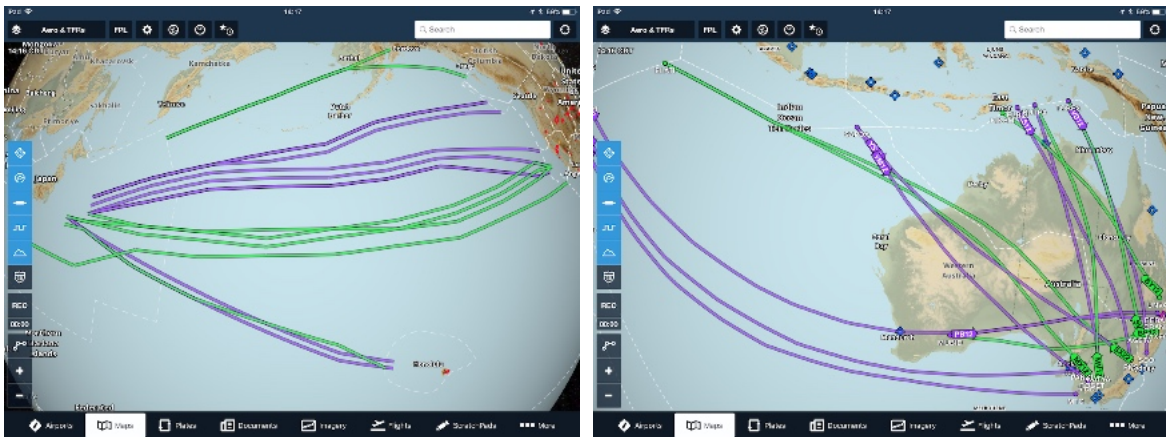

Display the tracks by selecting the Aeronautical Data layer, then tapping the Maps Settings (gear) button, selecting Airways, and turning the Organized Tracks switch ON. You can display only the tracks relevant to your direction of flight by de-selecting "East" or "West" as needed.

NOTE: Organized Tracks cannot currently be automatically added to a route, but the points on a track can be added manually using touch planning.

Global Airspace Details

ForeFlight Mobile v10.0 and later include Jeppesen-sourced global airspace information for FIRs, UIRs, controlled airspace, and Special Use Airspace such as MOAs.

Touch-hold on the Maps page, then tap the name of the airspace to highlight it. Tap the "Details" button next to that airspace to see information including center and radio frequencies, RVSM cruise tables, operational notes, speed restrictions, prior notification procedures, and communication details for CPDLC and satellite services.

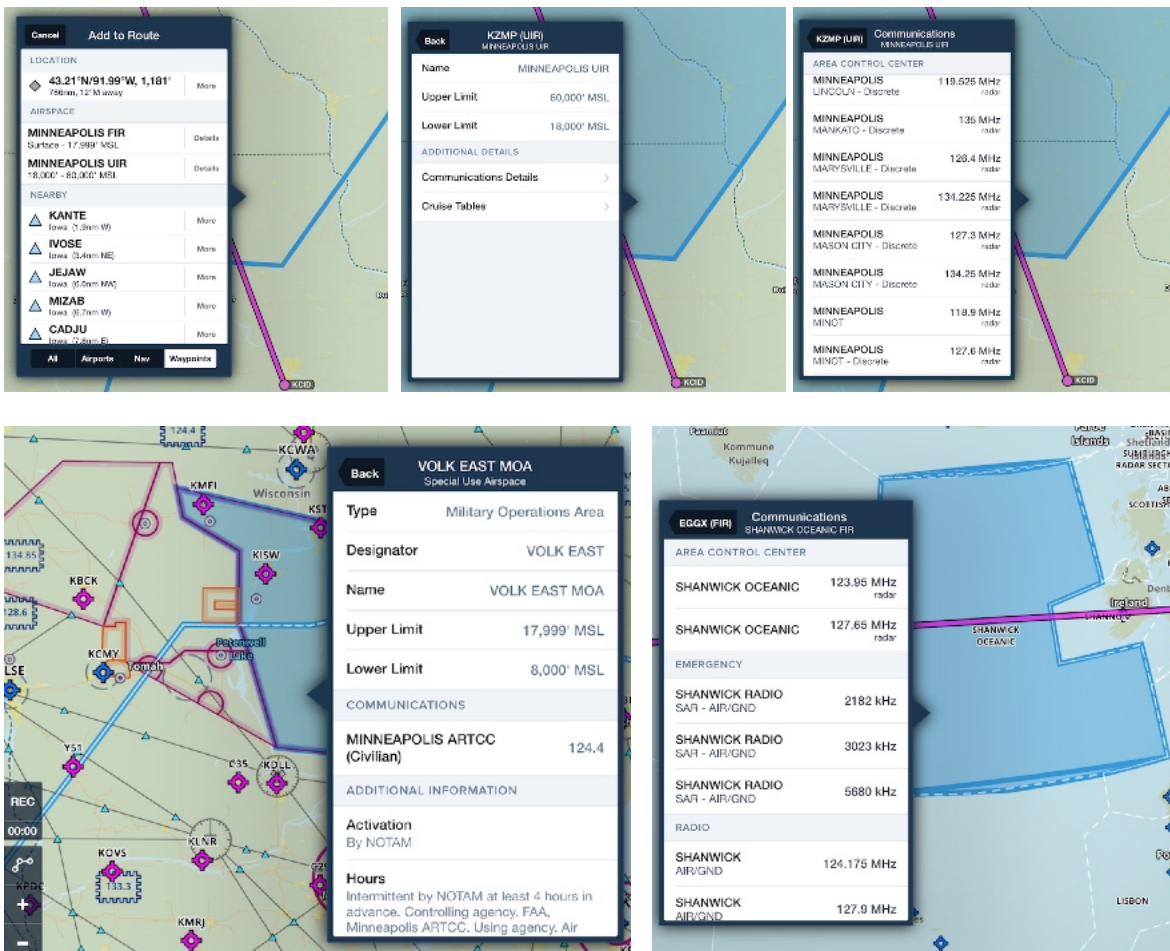

Maps Settings

Tap the Maps **Settings** button  next to the **FPL** button in the dark blue tool bar to show the following Map settings:

Screen Brightness

❖ The brightness slider integrates with the iPad's brightness slider, but allows for even more dimming (see the [Settings](#) section for more info).

❖ **Invert Chart Colors** - turn *ON* to invert black and white colors on charts for improved low-light viewing (does not affect Street or Aerial maps). This setting can also be independently enabled for Plates and Documents, and is controlled by the Day/Night/Auto App Theme selector in More > Settings. **NOTE:** The Aeronautical map and Jeppesen enroute charts are not affected by Invert Chart Colors, so you may want to choose the Dark Map Theme (see below) for low-light viewing when those are selected.

ForeFlight Map

❖ **Map Theme** - select the color theme of the base map. Three options are available: Classic, Light, and Dark.

❖ **Terrain** - select the terrain style to display on the base map. Three options are available: Off, Shaded Terrain (uses grayscale shading to depict local terrain variations), and Colored Terrain (uses colored shading to depict terrain elevation). Both low- and high-resolution worldwide terrain data can be downloaded.

❖ **Place Labels** - turn *ON* to add text labels that identify political and geographic features.

❖ **Cultural Elements** - Tap to select Major Roads, Minor Roads, Railroads, Urban Areas, Forests/National Parks, and Points of Interest.

Aeronautical (when Aeronautical layer is selected)

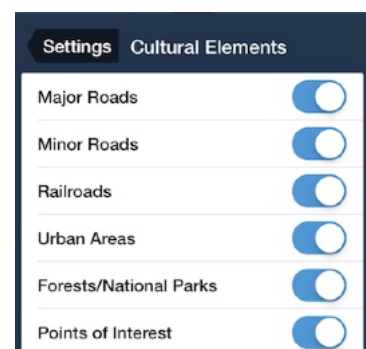
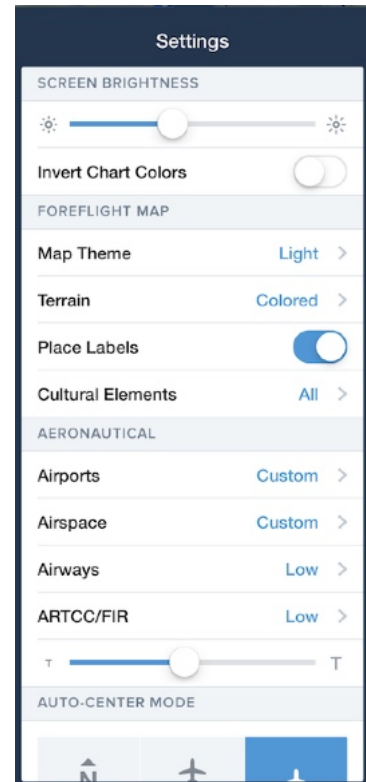

❖ **Airports** - toggle the display of airports on the map or customize it using the switches for heliports, private airports, and seaplane bases.

❖ **Airspace** - toggle the display of airspace on the map, toggle Automatic Highlighting of airspace, and customize it using the switches for Controlled airspace, SUA/MOA, TRSA, Class E (USA), Mode C, and ADIZ. The “Worldwide Altitudes” switch changes the airspace altitude labels to the new “tag” style labels:

B: 2000-7000

which automatically resize and reposition around airspace. Turning Worldwide Altitudes OFF changes US airspace altitude labels back to the traditional “Sectional” style, but removes airspace altitude labels from all international international airspace.

❖ **Airways** - change the airways, waypoints, and VOR radials shown on the map. Three options are available: Off, Low, and High.

❖ **ARTCC/FIR** - change the ARTCC frequency stamps shown on the map. Three options are available Off, Low, and High.

❖ Slider for adjusting the text size of aeronautical elements on the map. The full range of the slider goes from 75% to 150% of normal text size. The slider does not affect place labels or text on other maps or charts.

Jeppesen (when a Jeppesen enroute chart is selected)

❖ See [Using Jeppesen Enroute Charts in ForeFlight](#) for information on the available settings.

Auto-Center Mode

❖ Mode selector for auto-center/moving-map operation: North Up, Track Up Centered, Track Up Forward (see [Track Up](#) for additional information).

Map Overlays

❖ **Hide Distant Traffic** - turn ON to hide traffic beyond 15nm radius and +/- 3,500' from your location/altitude (setting is only shown when connected to an ADS-B receiver; see [ADS-B Traffic](#)).

❖ **Route Labels** - turn ON to enable waypoint and airway labels on route lines.

❖ **Extended Centerlines** - turn ON to enable extended runway centerlines at airports in the current route. Centerlines extend 5 NM from runway end.

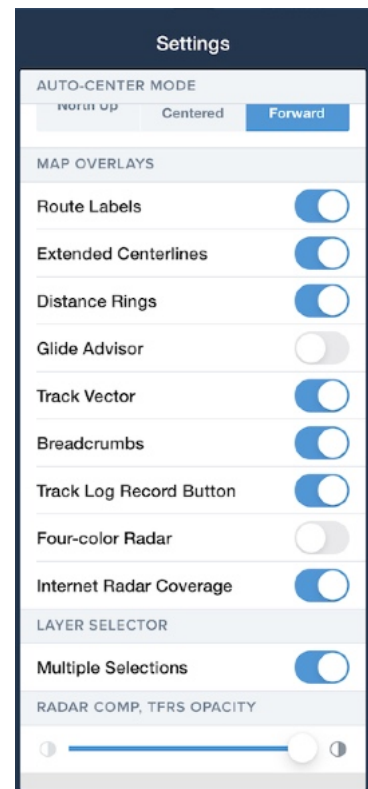

❖ **Distance Rings** - turn *ON* to enable three concentric rings around your aircraft (See [Distance Rings](#) for additional information).

❖ **Glide Advisor** - turn *ON* to enable the green Glide Advisor ring. Glide Advisor ring is hidden at GPS altitudes below 200' AGL.

❖ **Glide Settings** - select glide data to use for Glide Advisor, enter glide performance information (speed and glide ratio, assuming ratio is to 1, eg 8.0:1), and shortcuts to edit glide information for aircraft in the More > Aircraft menu.

❖ **Track Vector** - turn *ON* to display a projected track vector ahead of your aircraft icon (see [Track Vector](#) for additional information).

❖ **Breadcrumbs** - turn *ON* to display a thin green line indicating your recent track. The Breadcrumb trail will display whether or not a Track Log recording is active.

❖ **Track Log Record Button** - turn *ON* to display the "REC" button on the Maps view for recording ForeFlight [Track Logs](#).

❖ **Four-color Radar** - turn *ON* to display radar in a low resolution, four-color scheme that complies with dBZ-to-color mapping standards defined by the Radio Technical Commission for Aeronautics. See [Radar Legends](#) for more information.

❖ **Internet Radar Coverage** - turn *ON* to indicate areas of radar coverage. Areas with no coverage are shown with "Radar not available" and grey ////-marks across the map.

❖ **Map Touch Action** - select what happens when you tap on multiple overlapping charts. "No action" displays charts seamlessly stitched together in the default order. Choose "Bring chart to front" and single-tap the chart to cycle through the charts that overlap at that point. Choose "Bring chart to front with legends" to also show the chart legend and border when tapping to cycle through the charts. See additional details in the Map Touch section below.

Layer Selector

❖ **Multiple Selections** - turn *ON* to have the Maps Layer Selector remain open until you tap elsewhere on the screen so you can quickly toggle multiple layers on or off. On the Pad you can also pan and zoom around the map while the layer selector is open, even if the Multiple Selections setting is disabled.

Opacity Sliders

❖ Slider to change the opacity of radar, TFRs, and other weather layers, and another to change the opacity of plates overlaid on the map (see [Plate on Maps](#) for additional information).

Devices

❖ Quick access to external device status info (see [ForeFlight Connect](#) for information on compatible devices).

Map Touch

Map Touch is an enhancement to the traditional seamlessly-stitched charts that allows each individual chart to also be displayed either as a “trimmed” version without legends or margins, or as a “collared” version that shows the unaltered chart with all legends and borders.

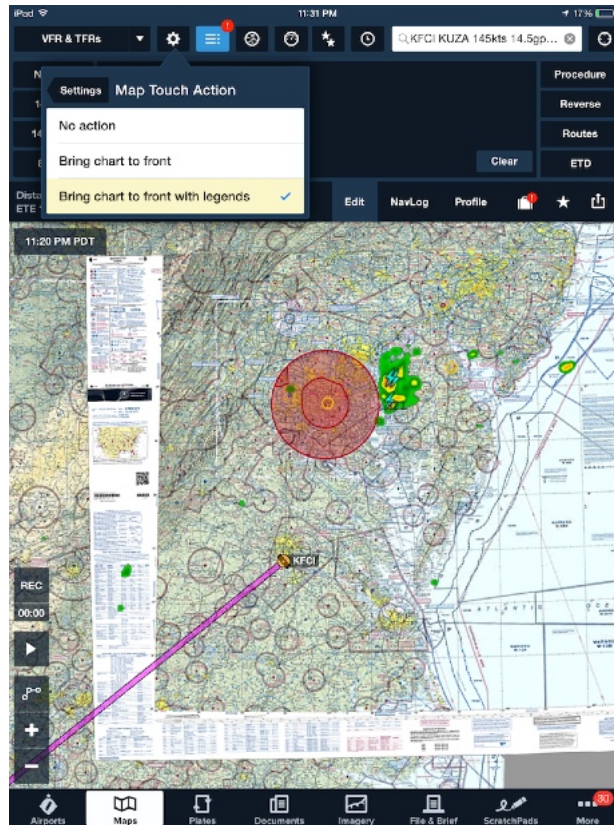

The Map Touch Action is selected using the Maps Settings menu, or in More > Settings.

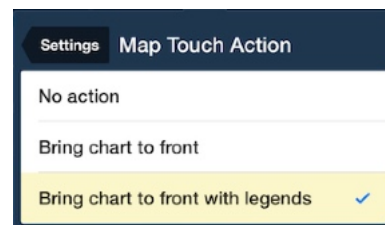
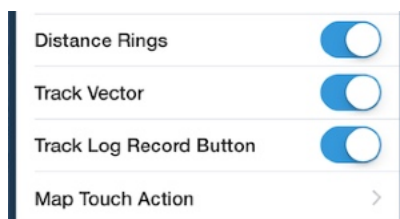

When **Bring chart to front** or **Bring chart to front with legends** is selected in Maps Settings, a single tap on a point where multiple charts overlap will cycle through the charts that overlap at that point. This is useful if there is information on one chart that is obscured by the seamless chart “cut” line. Additional single taps will bring each chart forward in turn.

Bring chart to front

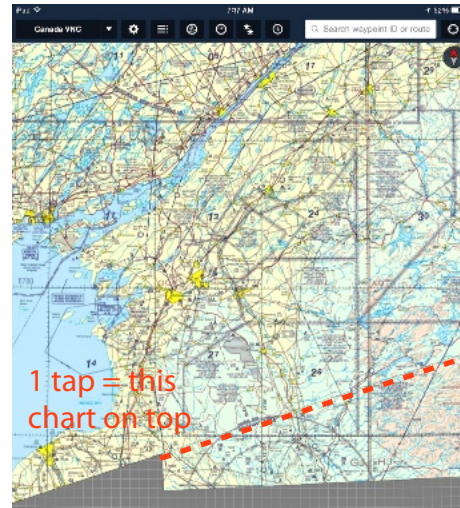

IMPORTANT: Because not every chart is published at the same time, airspace or restricted areas may not be depicted the same on overlapping charts. Consult all applicable charts when planning a flight.

Smart Airway Labels

When the route entered in the Route Editor includes one or more airways, dynamic labels appear along each airway segment with information about the segment, including the name of the airway, the segment's MEA, and the segment's MOCA, if it has one. These labels expand to fill available space between waypoints, adding more information as you zoom in.

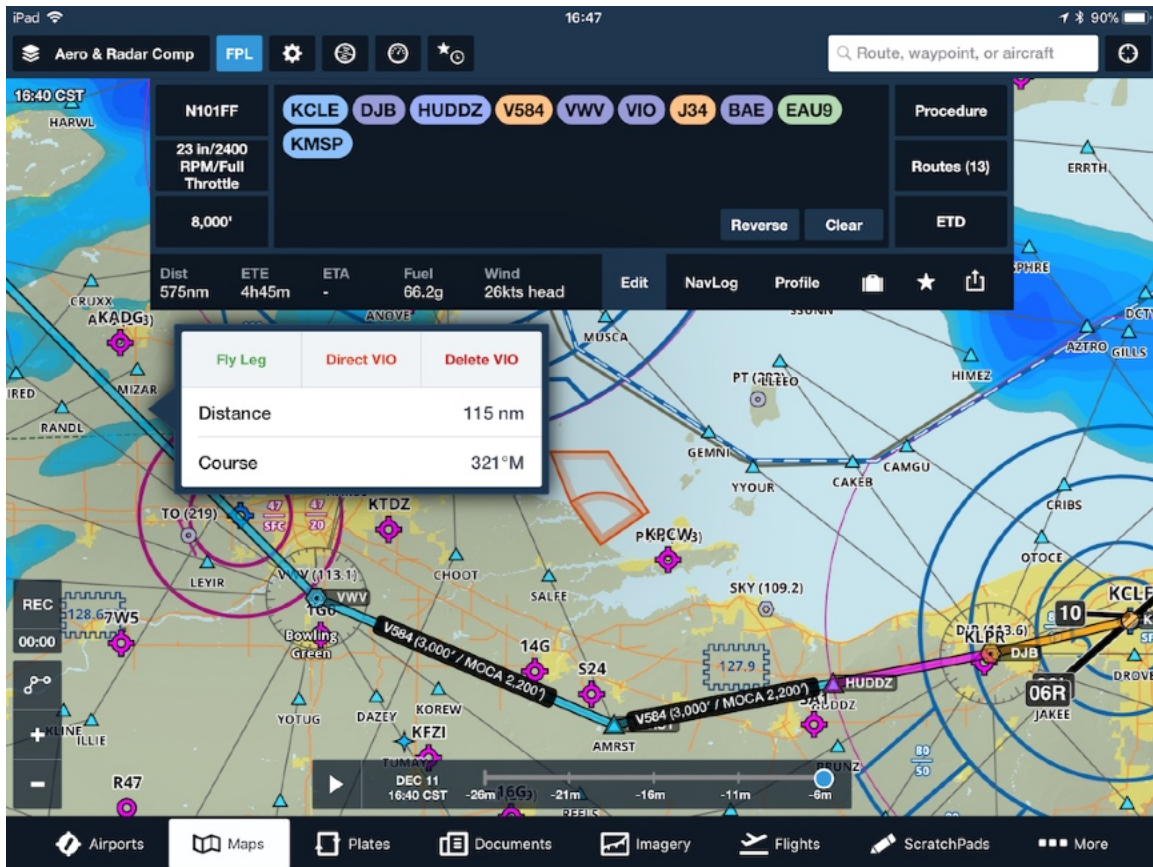

Smart airway labels only appear when an airway is explicitly named in the Route Editor, meaning that one of the route "bubbles" is the airway's name. To ensure all airway labels are shown, turn the Airway Decoding Setting to "All Waypoints Shown." Building a route with the individual waypoints in an airway but without naming the airway itself will result in the airway labels not appearing.

Smart airway labels are tied to other route labels, and can be disabled by turning off Route Labels in [Maps Settings](#).

Airport popup

The Airports popup allows you to quickly check the same information contained in the Airports view right on the Maps view.

When displaying the Aeronautical Map or a weather layer on the Maps view, tap on an airport's icon to display the Airport popup. The **Info** filter shows airport information like runways, frequencies, approaches, etc... The **METAR**, **Forecast**, and **Winds** filters show weather information, and the **FBO** filter shows FBO information and fuel prices.

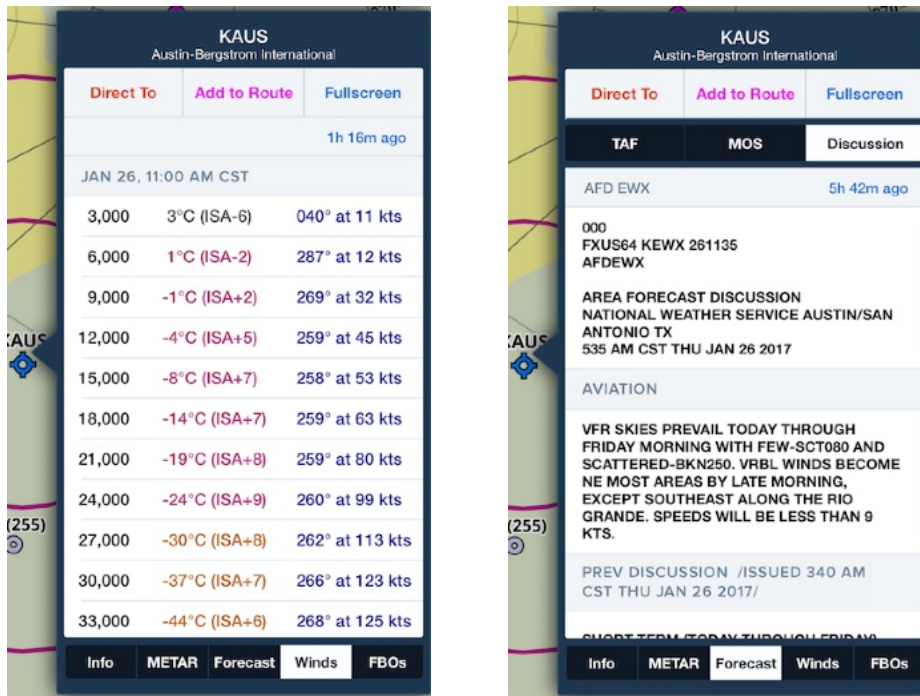



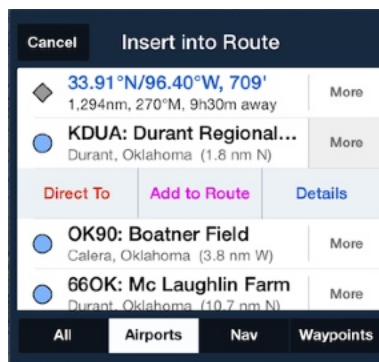













If a tappable layer is not selected, tap-hold on the map near the airport's location. Tap **More**, and then **Details** to display the Airport popup.













Single-tap an airport marker in the Synthetic Vision view to display the Airport popup. This allows you to easily view airport information in whichever view is most convenient, including in full-screen Synthetic Vision.

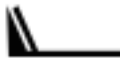

Weather Layer Color Coding

Weather Layer	Color coding	
Flight Category	<p> LIFR: Magenta. Ceiling less than 500' and/or visibility less than 1 mile.</p> <p> IFR: Red. Ceiling 500' to less than 1,000' and/or visibility 1 to less than 3 miles.</p> <p> MVFR: Blue. Ceiling 1,000' to 3,000' and/or visibility 3 to 5 miles inclusive.</p> <p> VFR: Green. Ceiling greater than 3,000' and visibility greater than 5 miles; includes sky clear.</p> <p> Unknown: grey question-mark</p>	
Winds Aloft <i>(wind barb color)</i>	<p>Altitudes < 12,000'</p> <p> 0-29 knots</p> <p> 30-39 knots</p> <p> 40-49 knots</p> <p> 50-59 knots</p> <p> 60-69 knots</p> <p> ≥70 knots</p>	<p>Altitudes ≥ 12,000'</p> <p> 0-69 knots</p> <p> 70-89 knots</p> <p> 90-109 knots</p> <p> 110-124 knots</p> <p> 125-149 knots</p> <p> ≥150 knots</p>
Surface Wind <i>(wind barb color)</i>	<p>Black: Peak <20 knots</p> <p>Orange: Peak 20-30 knots:</p> <p>Red: Peak >30 knots:</p>	

<p>Wind Barb symbology</p>	<p>Wind direction is in "true" degrees depicted by a stem (line) pointed in the direction the winds are coming from. Barbs indicate speed in 5 knot increments and can be combined on the stem to show faster winds.</p> <p>Short barb = 5 kts; Long barb = 10 kts; Flag = 50 kts</p> <p>Examples:</p> <div style="display: flex; flex-wrap: wrap; justify-content: space-around;"> <div style="text-align: center;"> Calm</div> <div style="text-align: center;"> Variable</div> <div style="text-align: center;"> 5 kts (330°)</div> <div style="text-align: center;"> 15 kts (190°)</div> <div style="text-align: center;"> 40 kts (330°)</div> <div style="text-align: center;"> 60 kts (270°)</div> </div>
<p>Dew Point Spread</p>	<p>4 0-4° C: Orange</p> <p>5 ≥5° C: Green</p>
<p>Temperature</p>	<p>2 <3° C: Red</p> <p>3 3-34° C: Green</p> <p>35 ≥35° C: Orange</p>
<p>Visibility <i>(same as Flight Category colors)</i></p>	<p>0 <1 SM: Magenta</p> <p>2 1-2 SM: Red</p> <p>5 3-5 SM: Blue</p> <p>6 >5 SM: Green</p>
<p>Ceiling <i>(same as Flight Category colors)</i></p>	<p>1 <500': Magenta</p> <p>5 500'-999': Red</p> <p>10 1000'-2999': Blue</p> <p>31 ≥3000': Green</p>

Sky Coverage	<ul style="list-style-type: none"><li data-bbox="605 212 802 275"> Sky Clear<li data-bbox="605 306 727 369"> Few<li data-bbox="605 401 808 464"> Scattered<li data-bbox="605 495 769 558"> Broken<li data-bbox="605 590 797 653"> Overcast<li data-bbox="605 684 911 747"> Vertical Visibility
--------------	-----------------------------------------------------------------------------------------------------------------------------------------------------------------------------------------------------------------------------------------------------------------------------------------------------------------------------------------------------------------------------------------------------------------------------------------------------------------------------------------------------------------------------------------------------------------------------------------------------------------------------------------------------------------------------------------------------------------------------------------------------------------------------------------------------------------------------------------

Attitude Indicator / Synthetic Vision

Tap the Attitude Indicator/Synthetic Vision (SV) button  at the top of the Maps page to view the Attitude Indicator display. On the iPad the display also includes GPS altitude (MSL), GPS ground track, GPS ground speed and GPS calculated rate of climb (ft/min). If connected to a Sentry or other supported AHRS-equipped external device, the display will also include AHRS-derived horizon (pitch & roll). However if using a GPS source that does not include an AHRS sensor, then attitude information (pitch, roll) is not displayed and the horizon will appear level regardless of your aircraft's attitude.

If you have a subscription that includes Synthetic Vision (SV), the display will also include a 3D depiction of the terrain ahead of you. Obstacles and Terrain are colored based on the relative altitude (tied to the Profile view altitude selection). By default, Obstacles or Terrain more than 1000' below you are colored green; within 1000' below your altitude are Yellow; and within 100' below to above your altitude are Red. The gridlines on the SV view are aligned North-South and East-West for easy orientation.



Attitude Indicator with GPS input but no SV subscription or AHRS input.

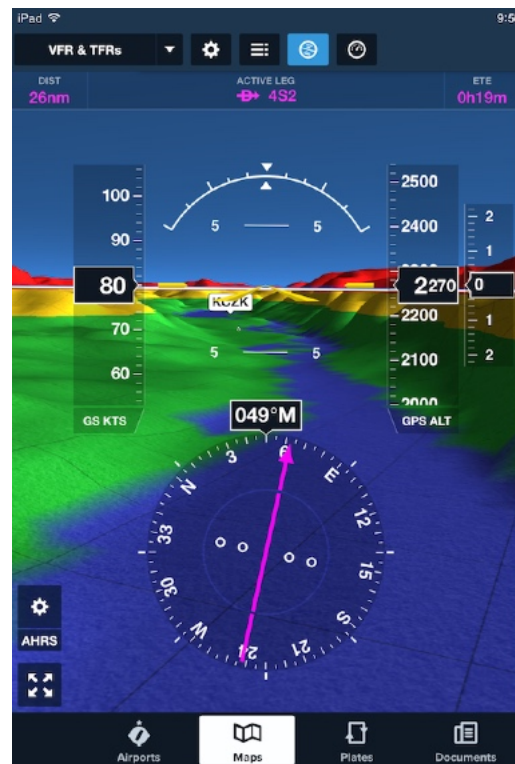

Attitude Indicator with AHRS input and SV subscription.

When the iPad is in Landscape orientation the AI/SV display is shown on the left side of the screen. When the iPad is in Portrait orientation the AI/SV display is shown at the top of the screen on the Maps page.

Tap the full-screen/half-screen button in the lower left corner of the screen to switch between split-screen and full-screen AI display in either landscape or portrait orientation.



iPhone Attitude Indicator/Synthetic Vision (AI/SV)

The iPhone AI/SV display is always full-screen, and does not include the “tapes” for Ground speed, GPS rate of climb, GPS altitude, or the Ground Track compass circle. However you can display the Instrument panel at the bottom of the iPhone screen and choose instruments such as GPS altitude, Ground Speed, etc...

The iPhone AI/SV display works in both portrait and landscape orientation on any iPhone currently supported by ForeFlight Mobile *except* the iPhone 5, 5C, 5S, and SE. The “blue over brown” AI view (the picture on the right) shows without a Synthetic Vision subscription.



NOTE: the iPhone Display Zoom View setting must be set to “Standard” to use SV.



IMPORTANT NOTICE: ATTITUDE INDICATOR DISPLAY

THE FOREFLIGHT ATTITUDE INDICATOR / SYNTHETIC VISION (AI/SV) DISPLAY IS FOR INFORMATIONAL PURPOSES ONLY. DO NOT USE THE FOREFLIGHT AI/SV DISPLAY AS A PRIMARY INSTRUMENT IN ANY PHASE OF FLIGHT.

THE FOREFLIGHT AI/SV DISPLAY SHOWS THE ATTITUDE OF THE AHRS-EQUIPPED EXTERNAL DEVICE. IF THE DEVICE IS NOT MOUNTED PROPERLY AND SECURELY IN THE AIRCRAFT, THE ATTITUDE SHOWN MAY NOT CORRESPOND TO THE AIRCRAFT'S ACTUAL ATTITUDE.

The AI display will automatically begin dimming to a darker "night" mode beginning 20 minutes before local sunset and will be fully dimmed 20 minutes after sunset. 20 minutes before local sunrise the AI display will automatically begin brightening to "day" mode.



Red chevrons are shown on the AI/SV display if the nose-up or nose-down attitude approaches 30 degrees. The chevrons point in the direction of pitch recovery.



In the event that AHRS or GPS data becomes unreliable, the affected instrument(s) will be X'd out until reliable data is received.

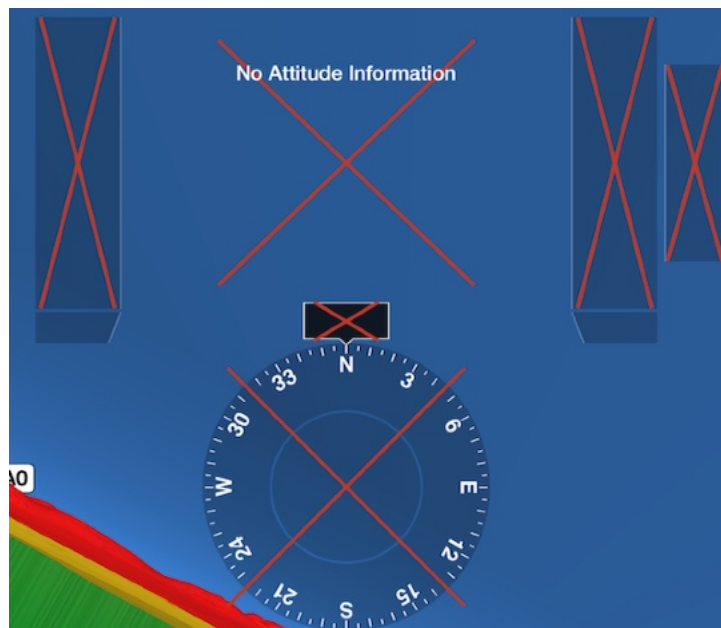

Glance Mode

Swipe within the Synthetic Vision window to enter Glance Mode, an interactive experience with zoomable 360-degree view of the terrain, obstacles, airports, and traffic (requires a compatible ADS-B receiver) around your aircraft.

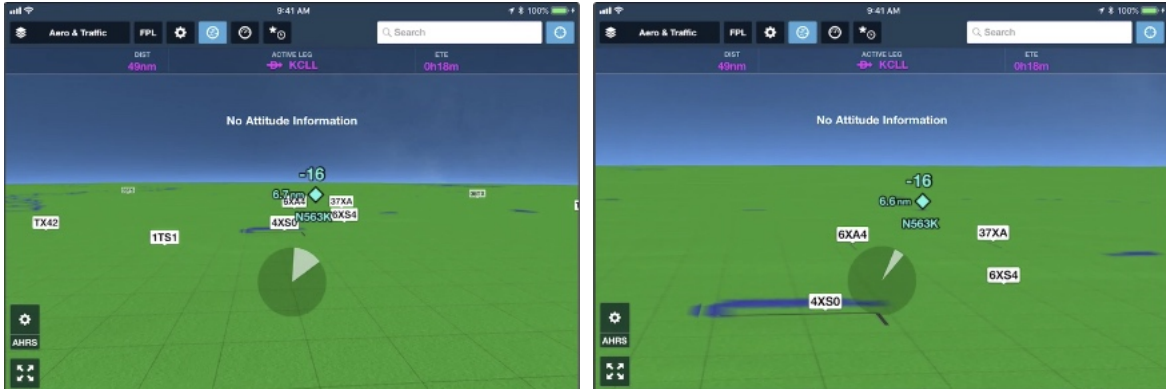

Once Glance Mode is enabled, the heading, altitude, and groundspeed indicators disappear to provide a more open view, and a circular field of view indicator including a “slice” appears to show the camera orientation relative to your ground track and the horizon.

Use single-finger touch to pan the view both horizontally and vertically, and use two fingers pinch to zoom in (up to 10x) and out. The view indicator “slice” narrows as the view zooms in, widens as the view returns to normal, gets shorter as the view tilts down, and gets longer the view tilts up:

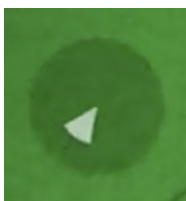

View tilted down

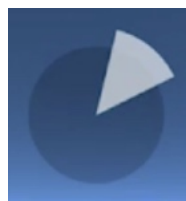

View tilted up



View zoomed out



View zoomed in

A radial timer begins moving clockwise around the view indicator after your last touch, and Glance Mode automatically exits if no touches are received within six seconds. In this example, approximately two seconds have passed since the last touch.



You can also tap on the view indicator to manually exit Glance Mode and return the view to its default forward direction.

Portable AHRS Positioning

For accurate pitch & roll indications a portable AHRS device should be positioned in the aircraft in a stable location that will not shift or move during the flight. If the portable AHRS shifts or moves, the AI/SV display may need to be recalibrated.

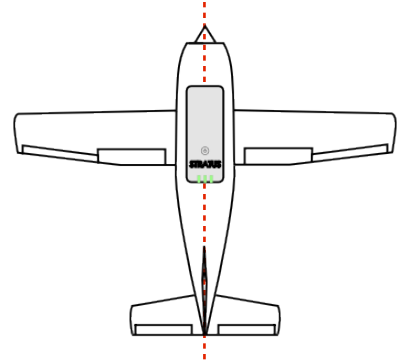

Calibrate the AI/SV display

When using an AHRS device, the Attitude Indicator can be calibrated to straight and level by tapping the AHRS “data source” label (1) in the lower-left of the Attitude Indicator display. Tap the “Calibrate” button (2) on the popup window and then tap on the “Zero Pitch & Bank” button (3) to automatically set the current condition as level, or on the iPad only you can tap on any of the four Pitch & Bank arrows to adjust the pitch and roll in small increments. To save the calibration tap the “Done” button (4) in the upper left corner of the display. Or tap the “Cancel” button (5) to cancel the calibration.

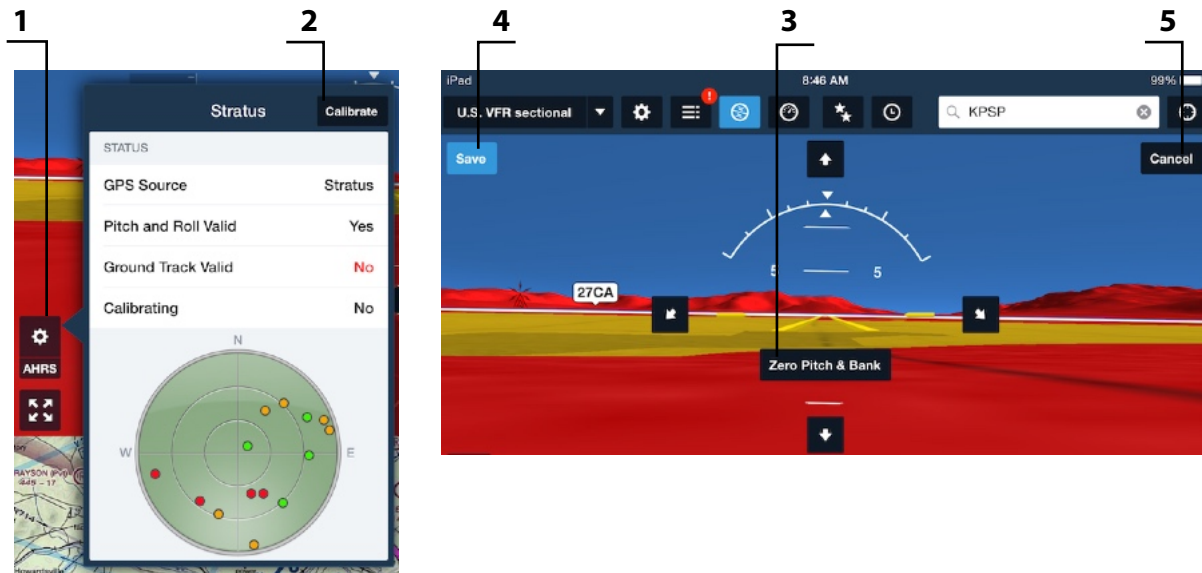

To calibrate the Attitude Indicator when using a Garmin Flight Stream 210 or Garmin GTX345, see [Calibrating Flight Stream 210 AHRS](#) and [Calibrating the GTX345 AHRS](#), respectively.

Synthetic Vision required downloads

To display Synthetic Vision terrain, you must first turn on the “High Resolution Terrain” switch in **More > Downloads > United States** (and/or **Canada** or **Caribbean, Mexico, Central America**), then tap the black <Downloads button to go back to the Download status page, and tap the blue “Download” button to download the High Resolution Terrain data, which includes the data for Synthetic Vision.

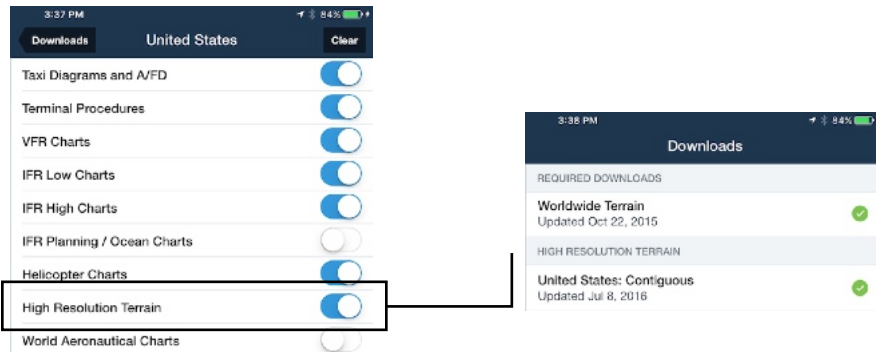

Finding an Airport, Navigation Aid, or Aircraft using Search

To quickly center the map on an airport, navigation aid, or waypoint, tap the *Search* box in the top right of the Airports, Maps, or Plates view. Type the location's identifier, and tap the **Search** button on the keyboard.

You can search by identifier, latitude/longitude, or bearing and distance from a waypoint.

The waypoint will be shown with a marker. Typing in a waypoint will not clear any route showing on the Maps view.

To remove the animated waypoint marker, simply tap elsewhere on the map.

Example Searches:

- ❖ **KJFK** - Centers the map on KJFK airport
 - ❖ **FLW** - Centers the map on the FLW VOR
 - ❖ **32.3N/99W** - Centers the map on the latitude/longitude
 - ❖ **324455/-0804557** - Centers the map on 32°44'55"N, 80°45'57"W
 - ❖ **N324455/W0804557** - Centers the map on 32°44'55"N, 80°45'57"W
 - ❖ **3244.92/-08045.95** - Centers the map on 32°44'55"N, 80°45'57"W
 - ❖ **3244556/-08045576** - Centers the map on 32°44'55.6"N, 80°45'57.6"W
 - ❖ **4952N** - ARINC 424 coordinates, centers the map at 49N 52W
- NOTE:** To enter latitude/longitude coordinates directly into ForeFlight on the web, use the form: **4015N10658W**. Latitudes must be 4 digits in the form DDdd and Longitudes must be 5 digits in the form DDDdd. If the Longitude is less than 100 then enter a leading zero eg: **4253N08549W**.
- ❖ **HIGAL/320/15** - Centers the map on 15nm bearing 320°M from HIGAL. If a VOR is given as the reference waypoint, then the directional information is assumed to indicate a radial, not a bearing
 - ❖ **LAX/246R/20** - Centers map on the 246 radial, 20nm from LAX
 - ❖ **LAX/246M/20** - Centers map on the 246 Magnetic bearing, 20nm from LAX
 - ❖ **LAX/246T/20** - Centers map on the 246 True bearing, 20nm from LAX
 - ❖ **MZB293/SLI148** - Centers map on intersection of MZB's 293 radial and SLI's 148 radial

*For more information about the following SAR grid waypoint options, see the Search and Rescue Supplement in **Documents** > **Drive** > **ForeFlight**.*

❖ **CAP@ORD451C** - Centers the map on the middle of CAP Grid ORD451, quadrant C.

❖ **CAP@40092CD** - Centers the map on the middle of CAP Cell Grid 40092CD.

❖ **GARS@176LW3** - Centers the map on the middle of GARS Grid 176LW, quadrant 3.

❖ **15RTN50008000** or **MGRS@15RTN50008000** - Centers the map on the middle of MGRS grid UTM zone 15, latitude band R, 100,000m grid square TN, easting 5000, northing 8000. MGRS coordinates no longer require entering MGRS@... before the coordinate values.

❖ **N####** or a **flight eg: ENY3961** - shows any flight that is either currently enroute, or scheduled to depart in the next 24 hours (based on currently filed flight plans) for that aircraft. Tap the entry to add that route to the NavLog.

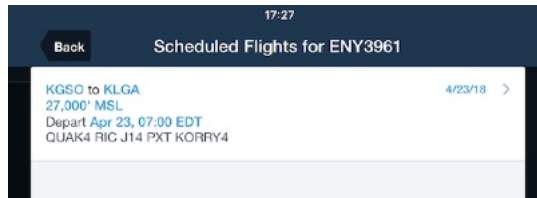

Airspace Information

To see information about Airspace, MOAs and Restricted Areas, tap-hold on the airspace or area on the Map. Airspace information is shown under the "Airspace" header. You can further highlight the airspace by tapping on its name in the popup. Tap **Cancel** (or anywhere on the screen) to close the popup.



Route Line

The route line drawn on the map is color-coded to indicate the active leg. **Magenta** is the current leg, **light blue** is a future leg, and **orange** is a past leg. Waypoints in the route are drawn with an icon to represent their type, such as a VOR.

You can tap on any leg in your route to access certain information and actions. The route leg popup includes the length and magnetic course heading of the route, and if the leg is part of a named airway, the popup also includes the name of the airway, the leg's MEA, and the leg's MOCA, if it has one. The buttons along the top of the popup allow you to activate the leg ("Fly Leg"), fly direct to the waypoint at the end of the leg, or delete the waypoint at the end of the leg.

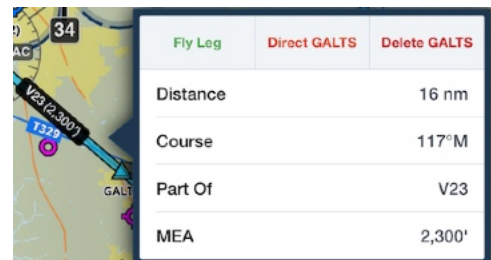

Working with the NavLog, Edit and Profile Views

Overview

Tap the FPL button in the Maps view toolbar to hide or show the Edit/NavLog/Profile views. To change between the views, tap the selectors in the lower portion of the overlay view.





At the bottom of the view is a summary of route and performance data (when available), as well as the effect of winds over the entire route. Winds are only incorporated if a true airspeed and altitude are provided as part of the route.

Winds aloft calculations also require an active network connection to retrieve the latest winds aloft forecast. However, once a forecast has been downloaded it will be saved for a few hours for use when offline.

To see your route without wind adjustments, disable your device's internet connection by turning off Wi-Fi and cellular or turning on Airplane mode.

The suitcase button  displays the Pack menu. Pack offers a 1-step method of downloading all chart, weather, TFR and fuel-price data needed for the route of flight currently in the Route Editor.

The star button toggles the favorite status of the current route. When the star icon is orange , the current route has been saved as a favorite. When marking a route as a favorite, you have the opportunity to name the route as something other than the default "<Origin> to <Destination>" name; having a custom name can be helpful when locating a route in the Favorite Routes list.

The rectangle-with-arrow button  is the **Send To** button. Tapping this will show multiple options:

- ❖ "Mail" creates a new email message with your navigation log and a screenshot of your trip. The message also includes a link that other ForeFlight Mobile users can tap to load your route onto their iPad or iPhone. **Note:** this option only appears if an email account is set up in your device's Mail app.
- ❖ "Flights" copies the current route and performance data to an empty flight plan on the Flights view. *Note:* tapping this button does not directly file the flight plan or submit a request for a briefing.





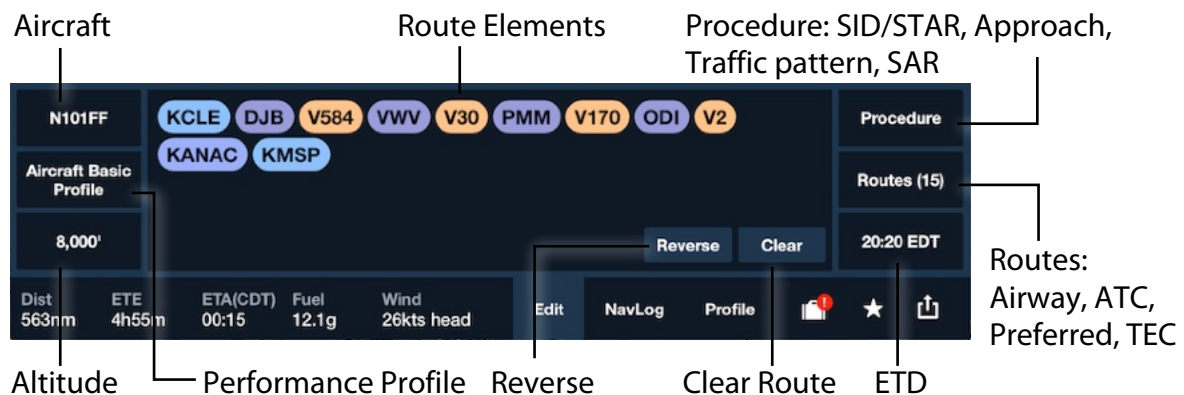

- ❖ “Logbook” creates a new entry in [ForeFlight Logbook](#) and auto-fills it with the current route, aircraft, and estimated time enroute. **Note:** this option only appears if you have a subscription that includes Logbook.
- ❖ “Print” allows printing of the navigation log to a connected AirPrint printer. (Requires iOS 4.2 or higher.)
- ❖ “Clipboard” will copy the flight plan to the iPad internal clipboard to allow “pasting” in another application.
- ❖ Other devices on the same Wi-Fi network that are running ForeFlight (listed by device name). See [Cockpit Sharing](#).
- ❖ Other - includes Social Media, such as:
 - ❖ “Twitter” composes a new Twitter message with your route and a screenshot of your trip. (Requires iOS 5 or higher, plus Twitter account setup in Apple Settings.)
 - ❖ “Facebook” composes a new Facebook post with your route and a screenshot of your trip. (Requires iOS 5 or higher, plus Facebook account setup in Apple Settings.)
- ❖ “LogTen” sends a copy of your route to the LogTen logbook app, if installed on your device.

Flight Plan Editor

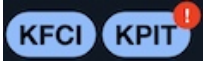
The Flight Plan Editor allows for easy creation and editing of routes on the iPad. To create or append to a route, simply tap the center area and use the keyboard to enter the new route element. Any route element accepted via the Search input is valid in the Edit View, including airways and SIDs/STARs. As you make changes to the entries, the Map and Route Editor will update to reflect the new route.

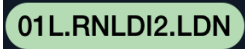

The Route Elements are color-coded for easier identification:

Airport		Airway (J or V)		VOR	
SID/STAR		Waypoint		NDB	
Traffic Pattern		Error			

Tap the Performance Profile button to choose the performance profile to apply to your flight. You can also override any profile information by typing a cruise speed, fuel burn, and/or altitude into the Route Editor. **NOTE:** Climb, Cruise and Descent performance information can also be entered into a Custom Performance Profile for your Aircraft on the **More > Aircraft** page.

Multiple Custom Performance Profiles can be created for each aircraft, and you can select between them by tapping the Performance Profile button.

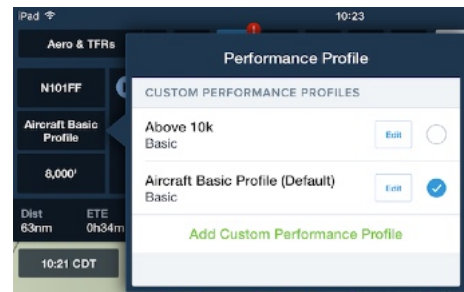

When there is a large difference between your aircraft’s climb speeds and fuel burns and cruise speeds and fuel burns, depending on the length of the flight you may see a meaningful difference in total time and fuel burns when using “Detailed” information (Climb, Cruise, and Descent speeds and fuel burns) instead of only an average fuel burn and speed. In the table below you can compare the time and fuel burn results for three different routes planned with “Detailed” (with all aircraft performance information entered) and “Simple” parameters.

Route	“Detailed”	“Simple”
(winds included)	<i>Climb: 100 kts, 20 GPH, 500 ft/min Cruise: 145 kts, 13 GPH Descent: 145 kts, 9 GPH, 500 ft/min</i>	<i>Fuel burn: 14.5 GPH Speed: 145 kts</i>
KMIC - KFAR (182nm) at 8000'	18.6 gallons, 1h23m	19.1 gallons, 1h19m
KPAO - KSMO (273nm) at 11000'	31.2 gallons, 2h09m	29.5 gallons, 2h02m
KHOU - KERP (587nm) at 6000'	60.8 gallons, 4h09m	59.9 gallons, 4h08m

If the default altitude for the selected aircraft is too high to be reached on the current route (eg: for a short route) the app will display a popup suggesting a lower altitude.

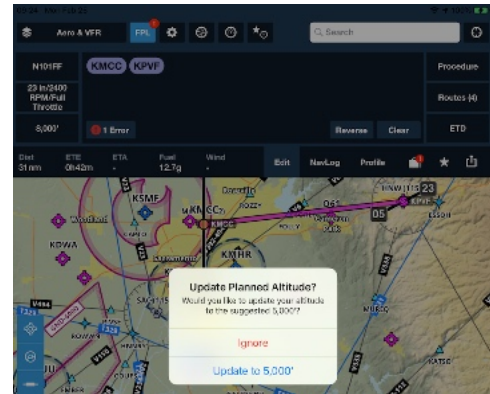

Performance Plus subscribers have access to advanced aircraft performance profiles developed by ForeFlight using aircraft manufacturer data. For additional details, see the Performance in ForeFlight Mobile guide, or visit www.foreflight.com/pricing to upgrade your subscription to Performance Plus.

The Altitude button displays the Altitude Advisor™ which shows the modeled winds aloft at various altitudes, provided the required route and performance data are available. Altitudes resulting in a net average tailwind over the route are shown in **green**, while those resulting in a net average headwind are shown in **red**. Airports included between the departure and destination in the Route Editor are treated as navigation waypoints, so the calculated time and fuel burn do not include descending to and climbing up from those airports.

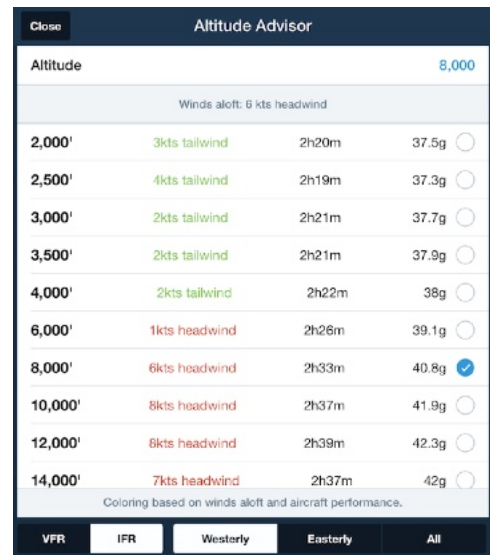

If you have entered your aircraft's [Climb performance](#) on the More > Aircraft page, the Altitude Advisor will automatically calculate whether it is possible to reach the listed altitude based on your aircraft's rate of climb and the distance of the route.

NOTE: If it will not be possible to reach an altitude given your aircraft's performance, the current winds, and time available before needing to descend, the Altitude Advisor will show "-----" for that altitude's row.

When connected to a Sentry or other ADS-B receiver or SiriusXM SXAR1, Altitude Advisor™ will only display wind effects if you have received recent winds aloft data for the entire route.

Procedure Advisor

The Procedure button in the top right of the Flight Plan Edit view opens the Procedure Advisor allowing you to add or replace Arrival procedures (STAR), Departure procedures (SID), Approaches, VFR traffic patterns and Search & Rescue (SAR) patterns in the route.

Departures, Arrivals, Approaches and Traffic Patterns require that at least one airport be entered in the Route Editor. SAR patterns can be entered without an airport in the Route Editor.

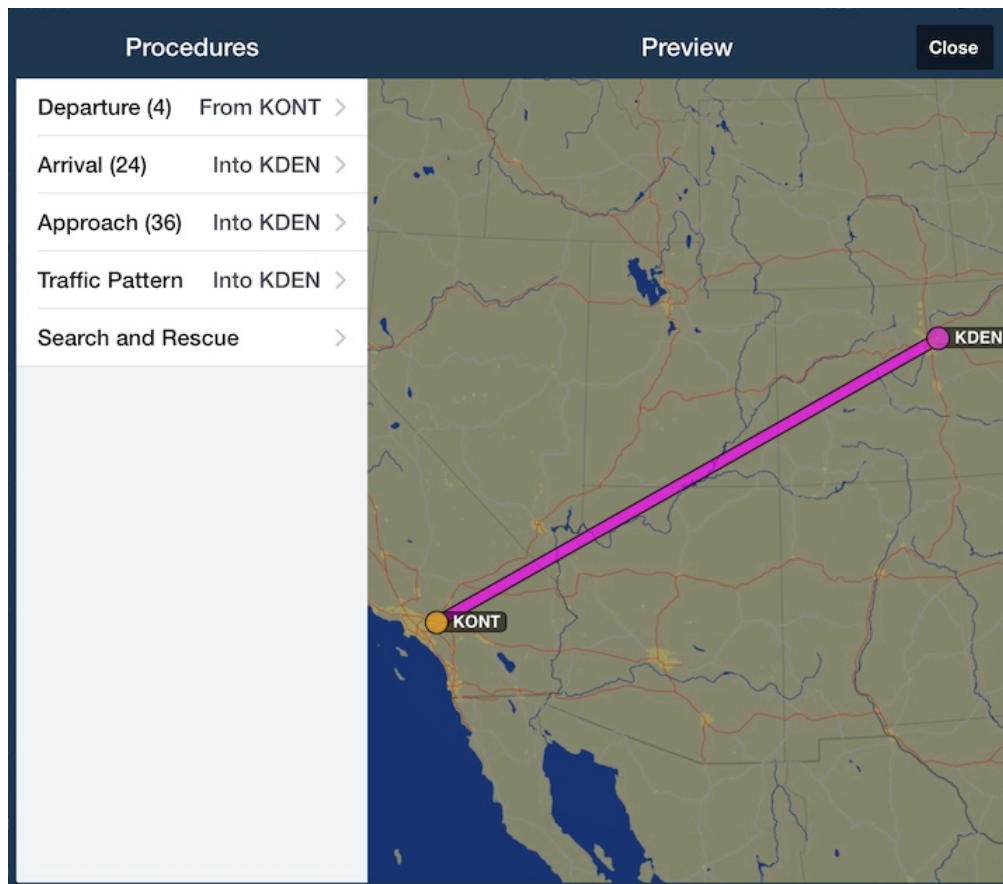

Departure

Tap **Departure** to see an inset map of the different SIDs available from the airport. The inset map can be panned and pinch-zoomed so you can see details of the different SIDs.

Tap a Departure name in the list on the left, or tap the boxed name on the inset map to see all of the transition options for that SID.

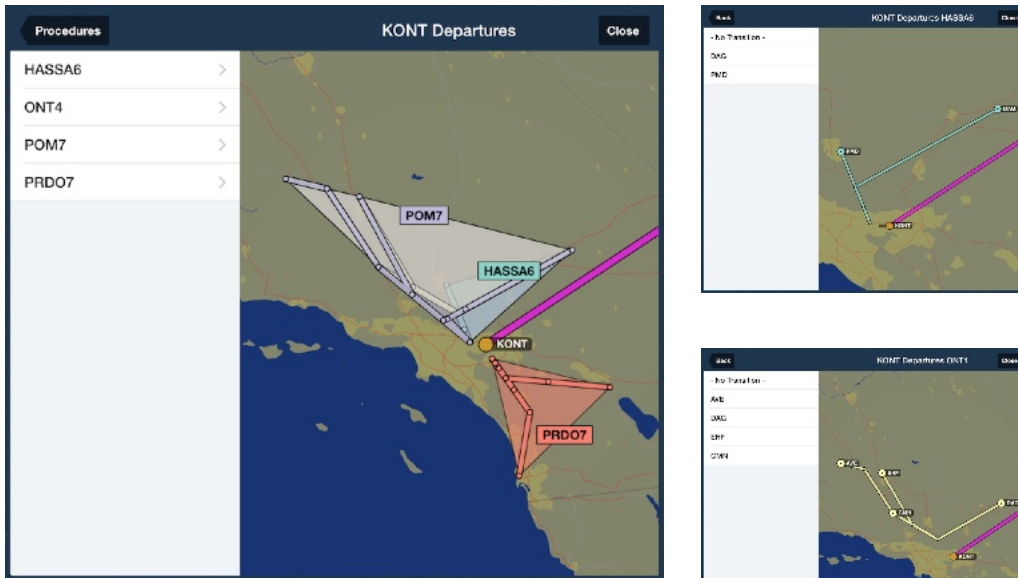

Then tap the Transition (and runway if required). When the desired SID, Transition and runway (if needed) are displayed, tap “Add to Route” to insert that SID into the route.

If you have Pro Plus or Performance Plus as well as Jeppesen coverage (purchased directly through ForeFlight or via a linked Jeppesen account) georeferenced SIDs/STARs will also be shown in the Procedure Advisor.

After adding a SID the Procedure Preview stays open so you can add additional elements to your route, such as an Arrival or an Approach.

To close the Procedure Advisor window and return to the Maps view, tap “Close” or tap anywhere not on the Procedure Preview window.

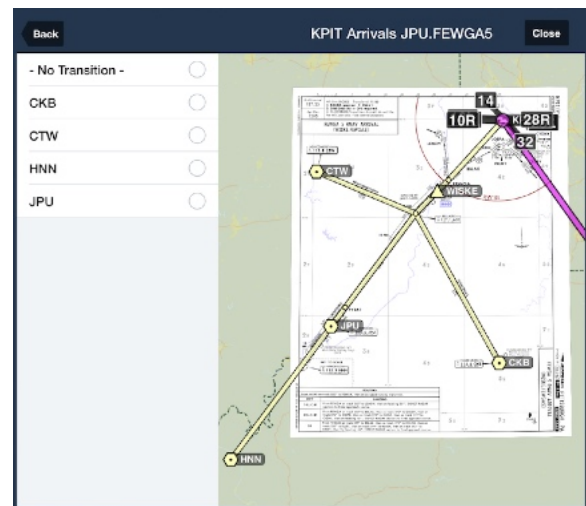

Once the Departure has been added you can change it or the selected runway by tapping the colored Departure oval in the Route Editor and choose **Change Departure...** or **Change Runway...**

Arrival

Tap **Arrival** to see a map of the different STARs available at the destination airport. As when adding a SID, tap an Arrival name in the list on the left, or tap the boxed name on the Preview map to see all of the transition options for that STAR.

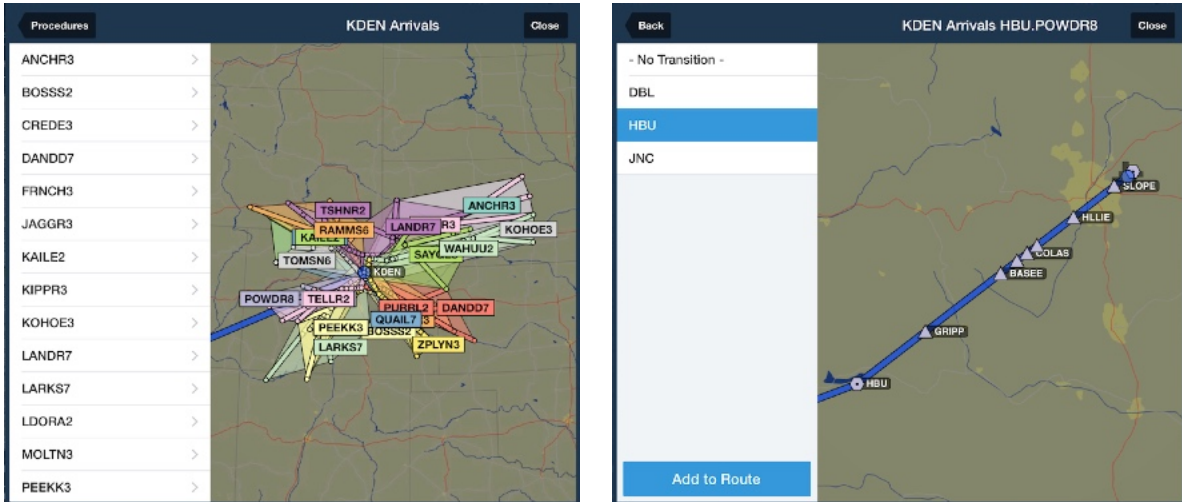

If the list of Arrivals is longer than the Procedure Preview window, scroll down to see the remaining Arrivals. Then tap the Transition (and runway if required). When the desired STAR, Transition and runway (if needed) are displayed, tap “Add to Route” to insert that STAR into the route.

IMPORTANT: Legs that cannot be depicted on the map, such as Radar Vectors, are depicted with a dotted-line.

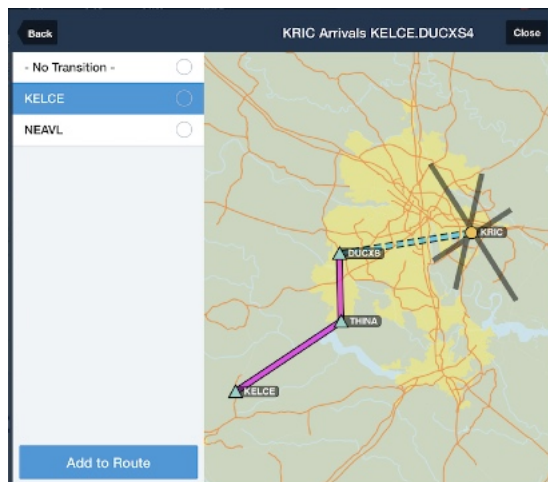
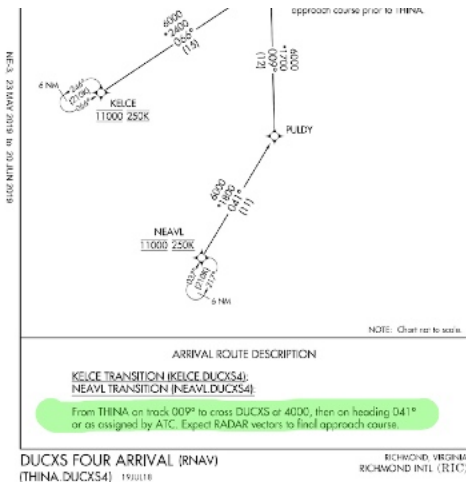

Once the Arrival has been added you can change it or the selected runway by tapping the colored Arrival oval in the Route Editor and choose **Change Arrival...** or **Change Runway...**

Approach

Tap **Approach** to see the available approaches for that airport. If a current METAR is available, the runways with the most favorable winds are highlighted in the list.

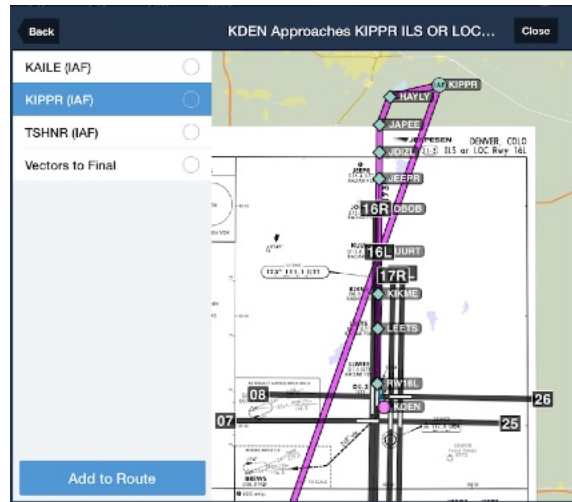
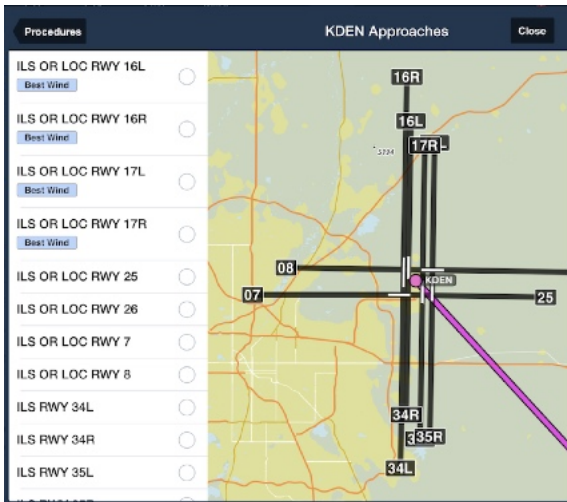

Tap an Approach to see the preview including the available IAFs. Choose an IAF by tapping in the list on the left, or on the Maps page, then tap "Add to Route."

If you have a Pro Plus or Performance Plus subscription, the plate associated with a given approach will automatically appear on the inset map when you select the approach, and will automatically be added to the Map when you close the Procedure Advisor.

And if you have a Performance Plus subscription the **Enhanced Approach Procedure Markers** will show the IAF and FAF with unique icons, and the waypoint labels include the crossing speed & altitude restrictions for each point.

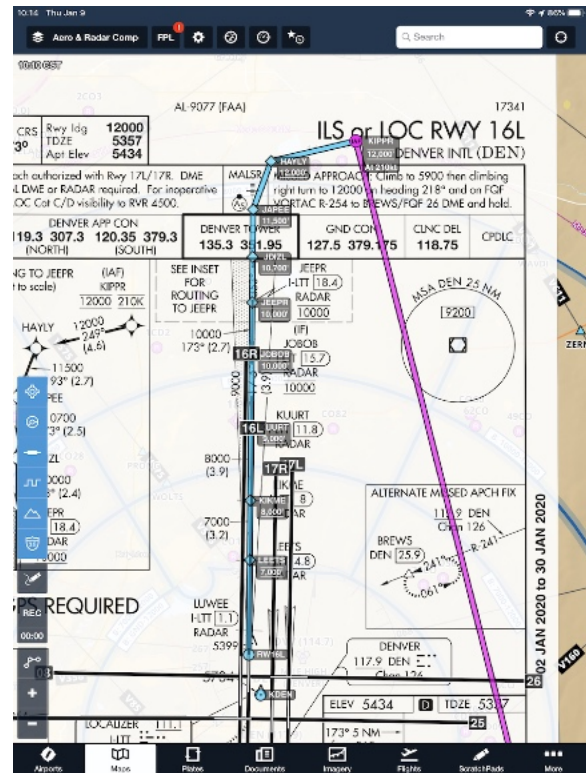

Once the Approach has been added you can change between approaches or IAFs by tapping the Procedure Advisor button again and selecting a new Approach. Or tap the colored Approach oval in the Route Editor and choose **Change Approach...** or **Change IAF...**

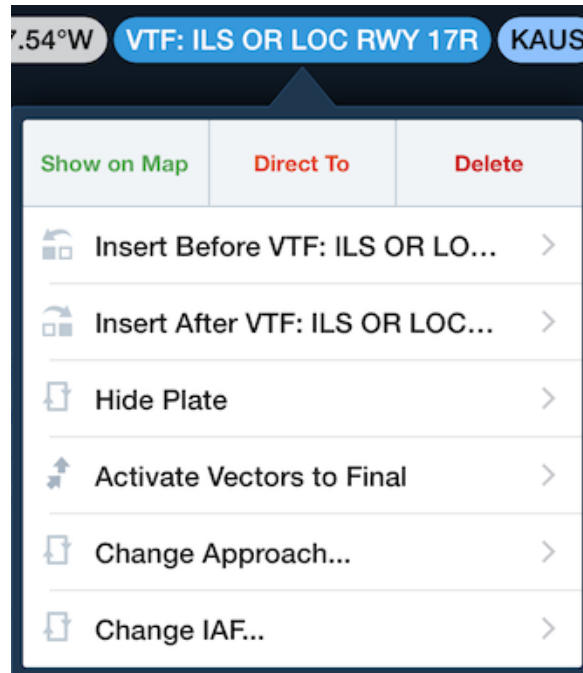

If an Approach entry includes a hold, ForeFlight Mobile will automatically insert the correct Direct, Parallel, or Teardrop entry based on the direction you're coming from.

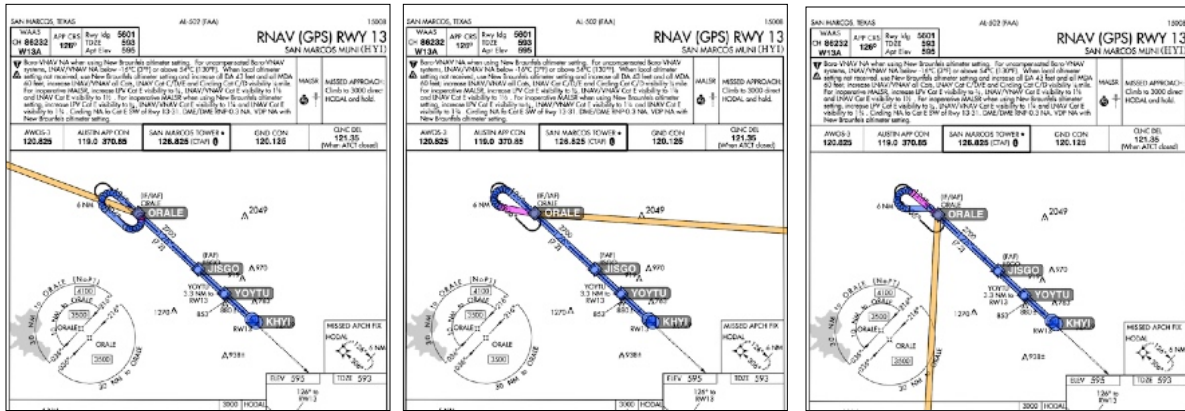

Direct Entry

Teardrop Entry

Parallel Entry

If a hold is automatically added as part of an approach but you want to remove it, tap the green approach "bubble" in the NavLog Edit box and tap "Remove Hold in lieu of PT". If you need to re-add the hold to the approach, tap the green approach "bubble" and tap "Add Hold in lieu of PT".

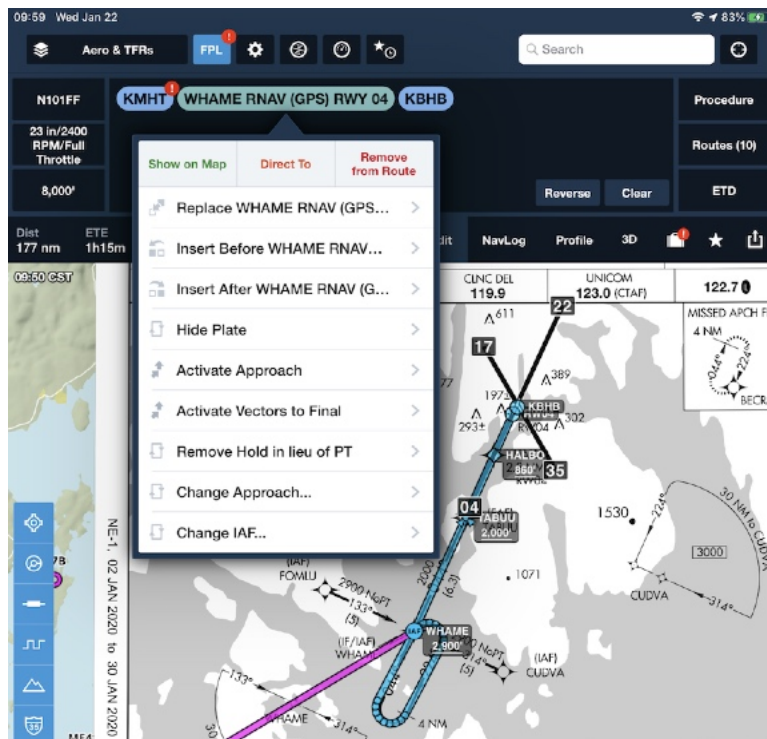

Activate Vectors to Final

Activate Vectors to Final erases any existing IAF, draws a light magenta 30nm extension from the FAF, and plots a direct-to route from your present position to a point 3nm outside the FAF. You can reactivate Vectors to Final anytime to redraw the line from your current position to the point 3nm from the FAF.

Tap the colored Approach oval in the Route Editor and choose **Activate Vectors to Final** or tap the Procedure Advisor button and re-select the approach and choose Activate Vectors to Final.

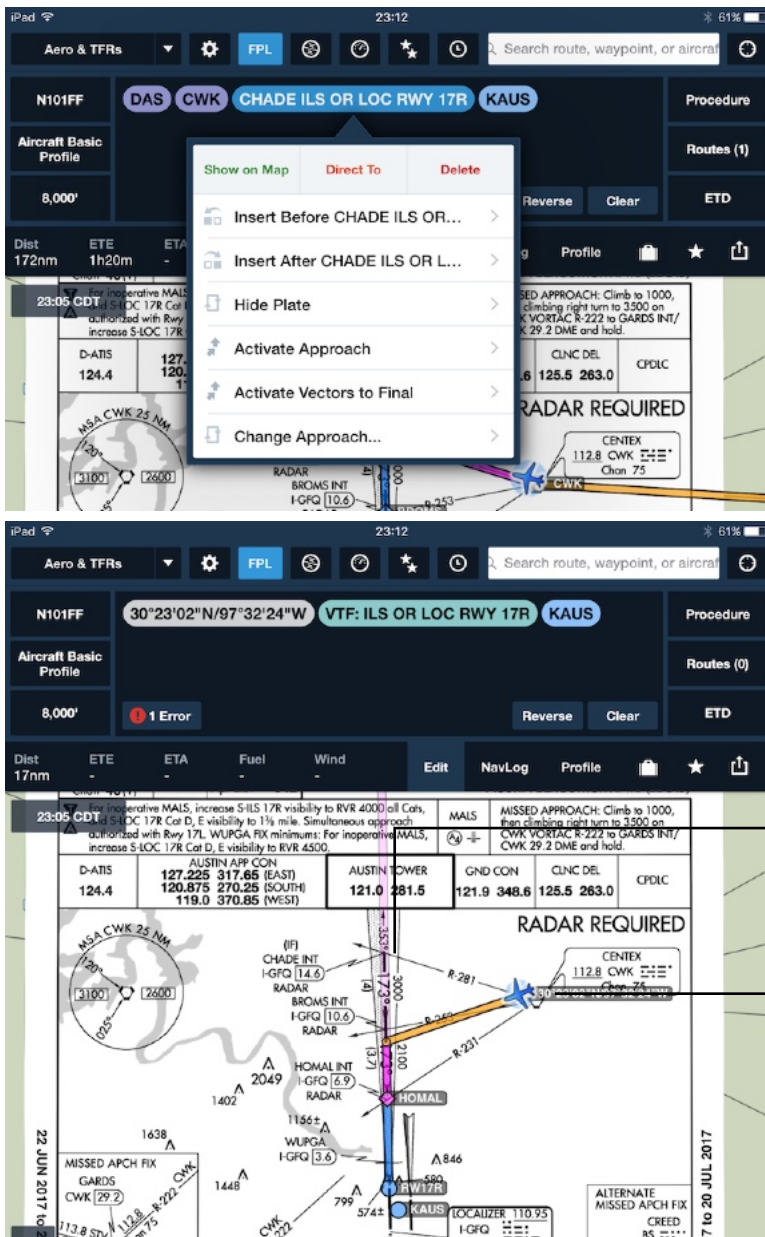

Traffic Pattern

Tap the **Procedure** button, then tap **Traffic Pattern** to display VFR traffic patterns for the airport at the end of the current route. If current winds are available, the runway selections with the best winds are highlighted in the list. Wind direction, speed and age of observation are also shown at the bottom of the list (scroll down if necessary to see the winds).

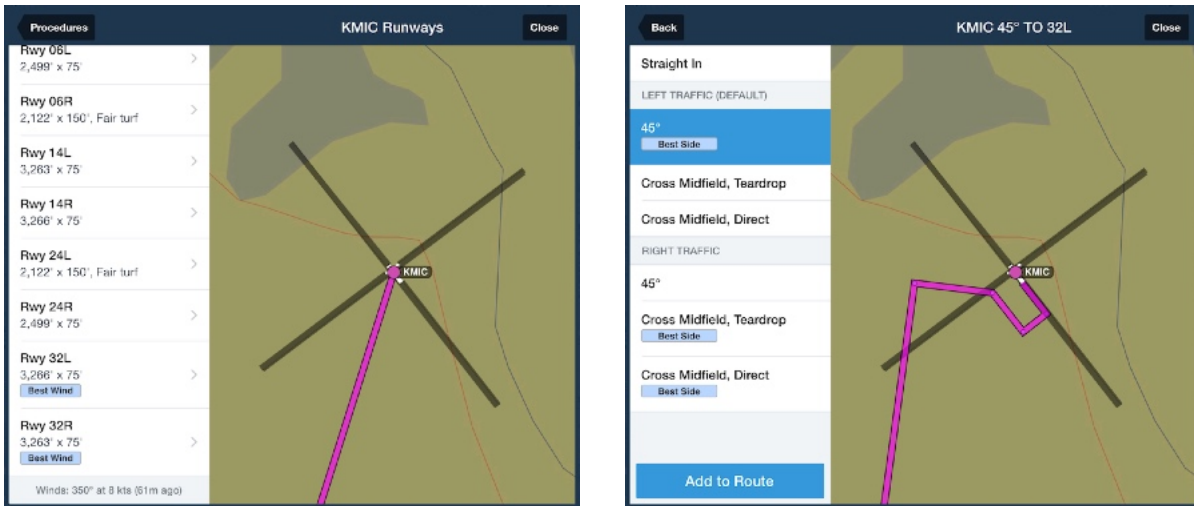

After selecting a runway the available pattern entry options are displayed, such as Cross Midfield or Straight-in. For non-towered airports the entries are sorted based on each runway's pattern side (right or left).

Additionally, entries are highlighted that make the most sense for your route's direction of flight. Tap an entry to add it to the end of the current route (or to replace one already in the route). Traffic patterns are automatically removed from a route when certain route edits are made, such as reversing the route.

IMPORTANT: Traffic patterns cannot currently be sent to another device via [Cockpit Sharing](#).

Search and Rescue

On the iPad, **Search and Rescue** (SAR) patterns can also be inserted using the **Procedure** button (when the Enable Search and Rescue setting is ON). For more details about SAR features, see the Search and Rescue Supplement, in **Documents > Drive > ForeFlight**. SAR patterns created on an iPad can be sent to an iPhone, but cannot be created on an iPhone.

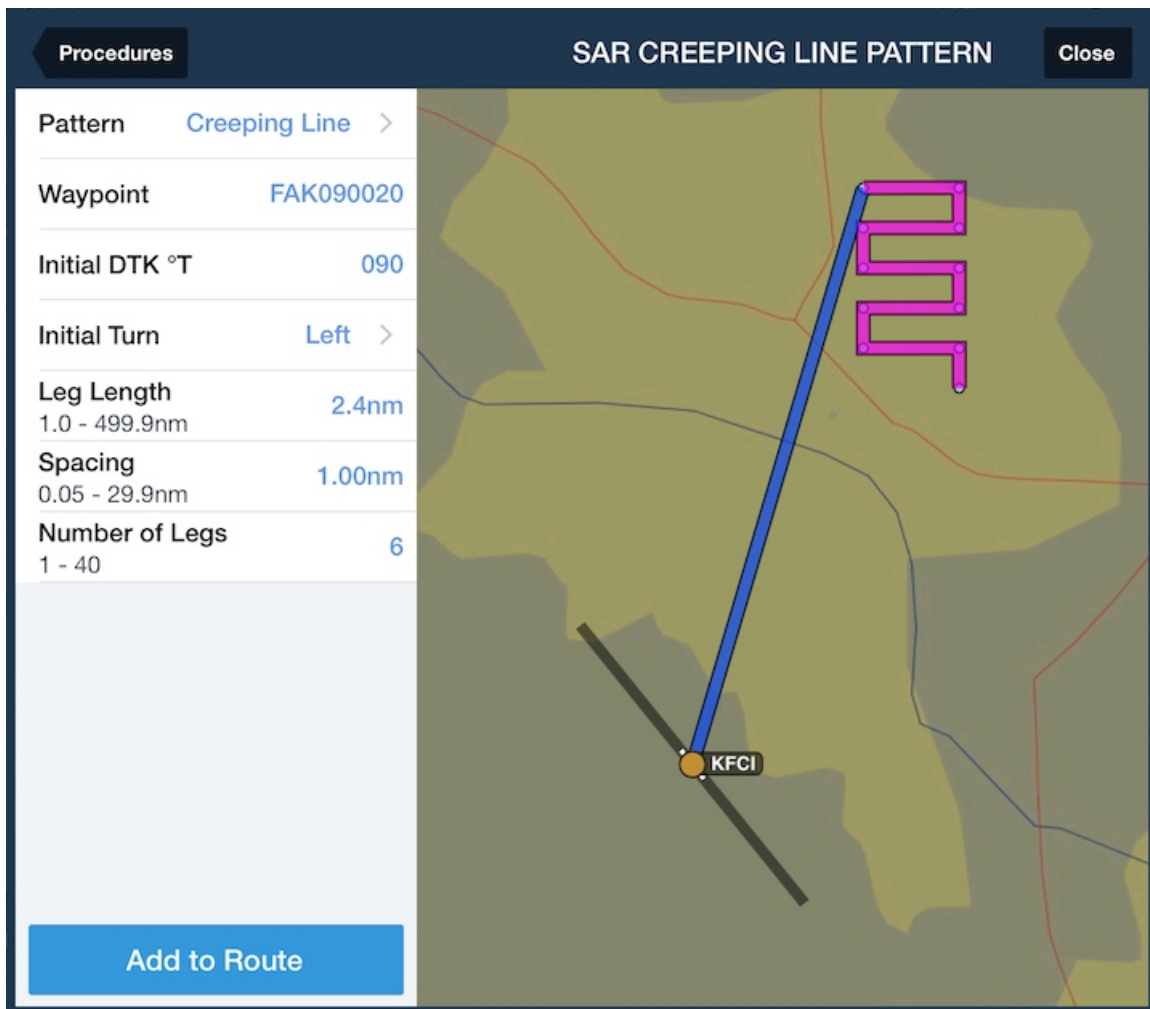

Reverse

The Reverse button reverses the current route, and removes SIDs, STARs and Approaches.

Route Advisor

The Routes button opens Route Advisor, which displays a list of potential routes that you can select for a pair of departure and destination airports. To the right of the list is a Route Preview, showing the path of every route on an interactive map. Tap on a route in the list to highlight it on the map. You can pan and zoom around the Route Preview map and tap the Zoom to Route button in the bottom left to return to a view of the full route. Tap Select Route after tapping on a route in the list to add the route in the Route Editor. This will replace any route that is already there.

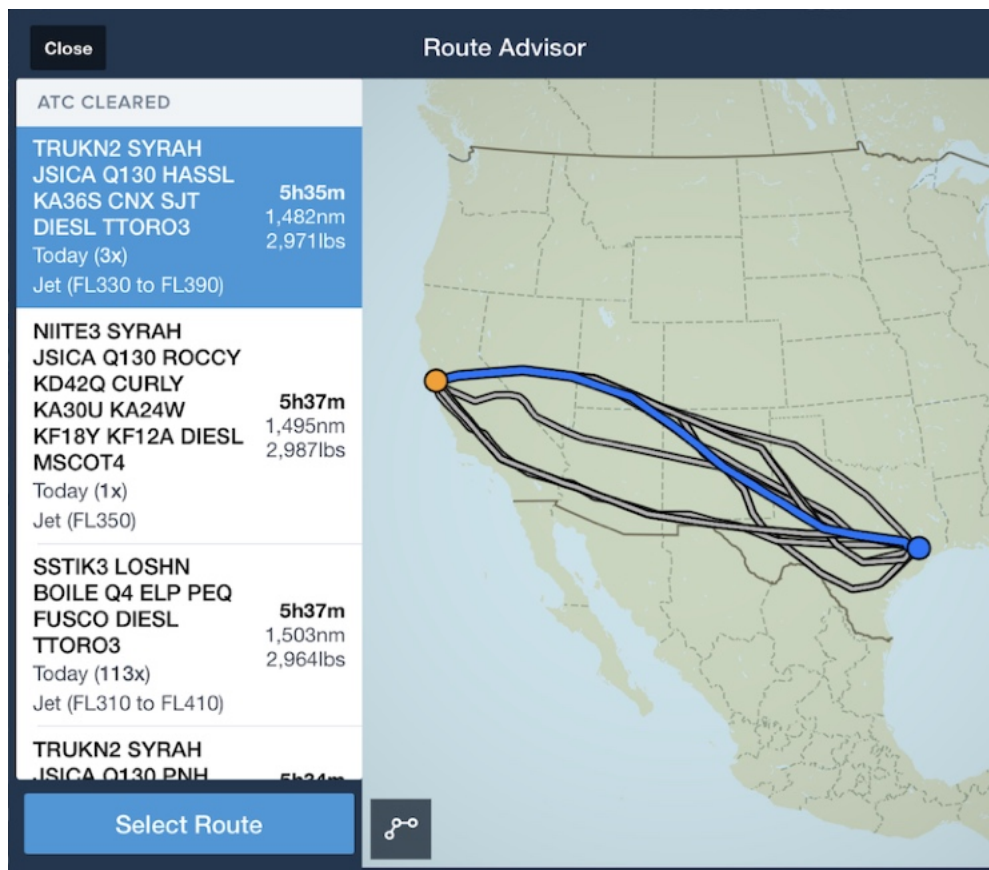

When a Performance Profile has been selected, the estimated time enroute and fuel burn based on that profile are shown for each route on the right, along with the route's total distance.

Route Advisor requires an internet connection to load new routes for an airport pair, but once those routes are loaded they can be viewed offline as long as the same departure and destination airports are entered in the Route Editor.

Types of routes shown include:

❖ **Recommended (Performance Plus only)** - provides the best route based on your aircraft, time/fuel savings, and chance of being cleared as filed. See the Performance Planning in ForeFlight Mobile guide for more information.

❖ **TEC/Preferred** - these routes are commonly used and may include an altitude or range of altitudes that are typically given with the route.

❖ **ATC Cleared** - these are routes that ATC has cleared in the recent past. These show the departure time of the most recently-cleared flight, the number of times a route has been cleared in the past year, and the type of aircraft and clearance altitude for which the route was given.

❖ **Airway** - these are victor-airway based routes.

Close

ATC CLEARED

Q128 JSICA MLF
J58 RSK FTI TCC
BGS SJT JCT SAT
HTOWN2
Yesterday (12x)
Jet (FL290 to FL390)

5h52m
1,542nm
3,103lbs

PREFERRED

BOILE Q4 ELP PEQ
FUSCO DIESEL
TTOR03

5h32m
1,484nm
2,929lbs

BOILE Q4 ELP PEQ
FUSCO DIESEL
MSCOT4

5h33m
1,487nm
2,934lbs

AIRWAY

SFO V87 SNS V137
AVE V248 EHF V197
PMD V137 PSP V16
VICKO V94 SFL V222
JCT V306 TNV V571
IAH

5h36m
1,497nm
2,957lbs

Select Route

Route Advisor - Eurocontrol Valid and Invalid Routes

For any route that passes through Eurocontrol airspace, Route Advisor will evaluate the route against Eurocontrol's complex system of route constraints and display a "Eurocontrol Valid" or "Eurocontrol Invalid" label beneath the route. For European routes the Route Advisor will also show if a route is Y or Z.

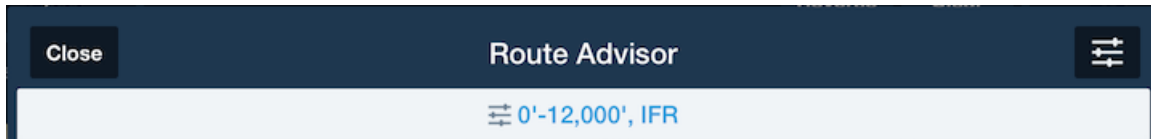

If needed to find a "Eurocontrol Valid" route through complicated European airspace, tap the "Constraints" button in the upper-right corner of the Route Advisor window to choose maximum and minimum altitudes, as well as flight rules (VFR, IFR, Y, Z).

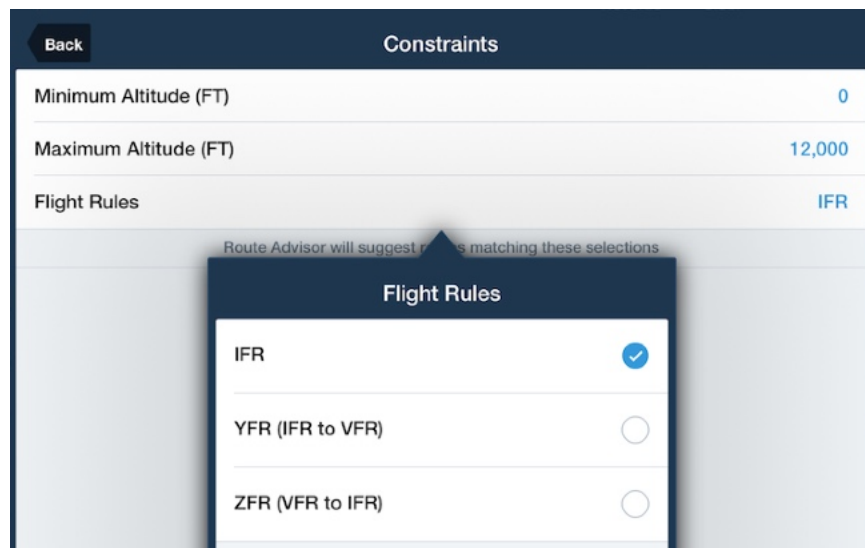

IMPORTANT: Eurocontrol validation may fail if you aircraft's ICAO configuration is incomplete or incorrect. Before planning a flight, make sure to correctly set-up your aircraft's ICAO configuration in [More > Aircraft](#).

Route Editor

The Route Editor is used to add, reorder, or remove route items. A route item is any airport, NAVAID, waypoint, airway, or other route element. To add an item to the end of the route, tap anywhere in the dark blue area of the Route Editor. This will show the keyboard. Type in the ID of the route entry to add.

To jump to an entry on the Map, tap the entry and tap the "Show on Map" button.

To go Direct-To a route entry, tap it and tap the "Direct To" button.

To remove an entry, tap it and select Delete. Alternatively, you can hold your finger on the entry briefly to "pick it up." Then drag it out of the Route Editor and release it to delete it.

To move an entry, touch-hold on it to "pick it up" then move it to the new location and lift your finger to "let go."

To add a route item in the middle of the route, tap any existing item to display the action menu for that item. Tap either of the "Insert..." buttons to show the ID entry field. Type in the new entry to add and press Insert or tap the return key on the keyboard.

Tap on the Departure or Destination bubble and choose **Select Runway...** to open the runway selection pop-up. The pop-up shows a list of available runways along with the most recent wind data.

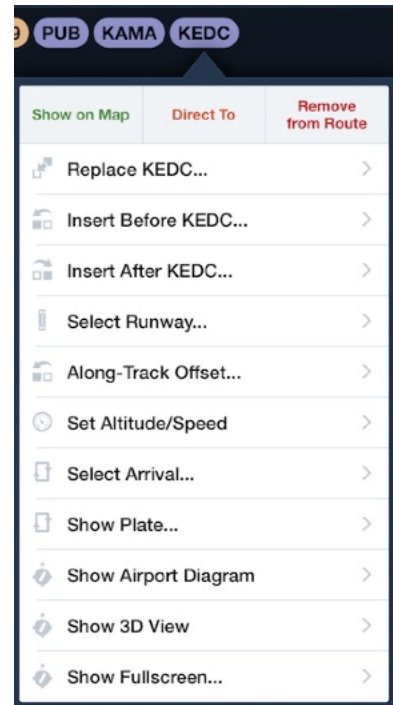

When you choose a runway, that runway is then highlighted on the Maps page: at the Departure airport with blue chevrons on the runway and white chevrons

extending out from the runway centerline, and at the Destination airport with an extended blue line with white chevrons leading to the runway centerline.

NOTE: if you choose a runway and traffic pattern via the Procedure Advisor, the blue chevrons will reflect that runway choice.

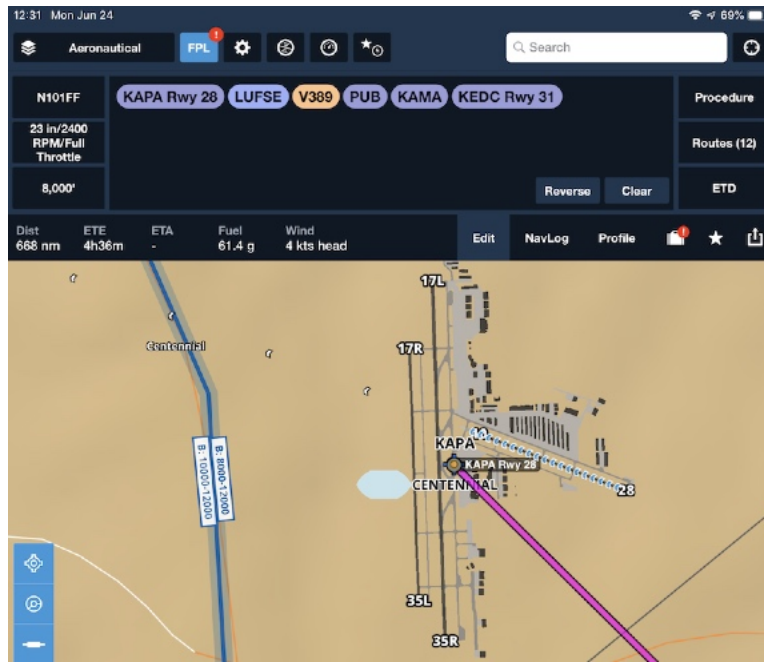

Departure: blue chevrons on runway, white leading away from runway

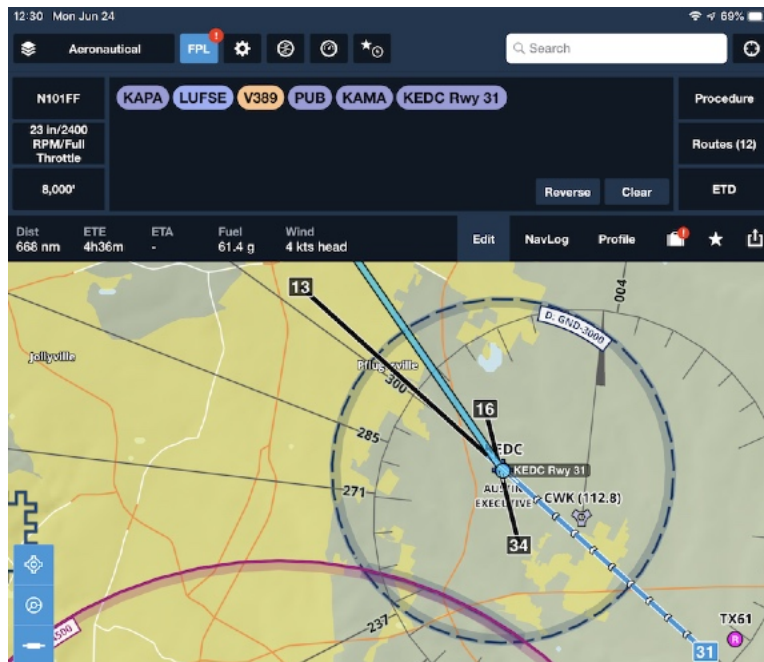

Arrival: blue line and white chevrons leading to runway

The **Along-Track Offset Before...** option allows you to add a point at an arbitrary distance before the end of the leg. Multiple Along-Track Offsets can be added to your route, and to an individual leg.

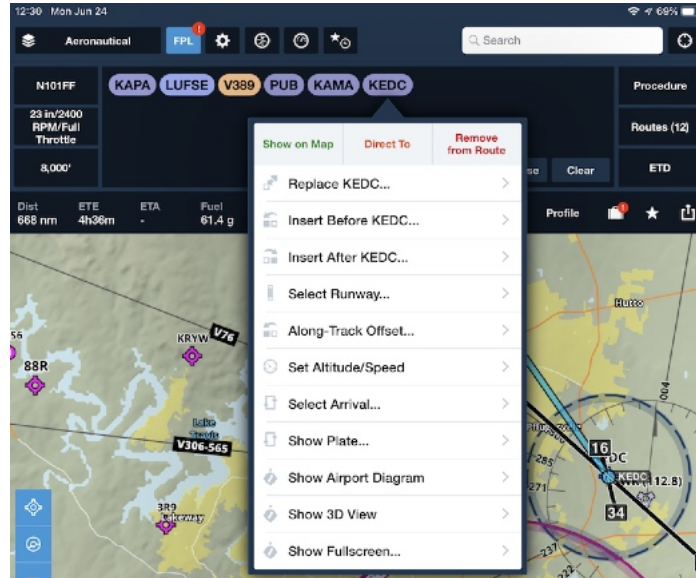

When you tap “Along-Track Offset Before...” the popup shows the total distance of that current leg. Enter the distance in nautical miles before the ending point (eg: a distance less than the total distance) at which you would like to add the point.

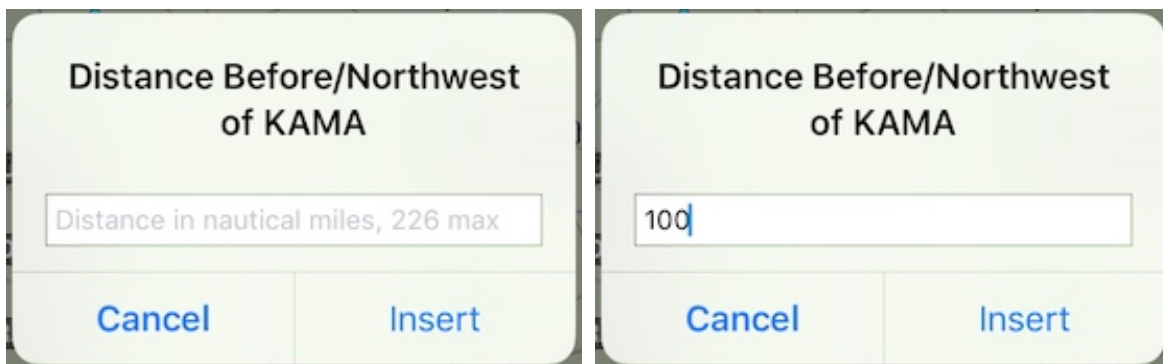

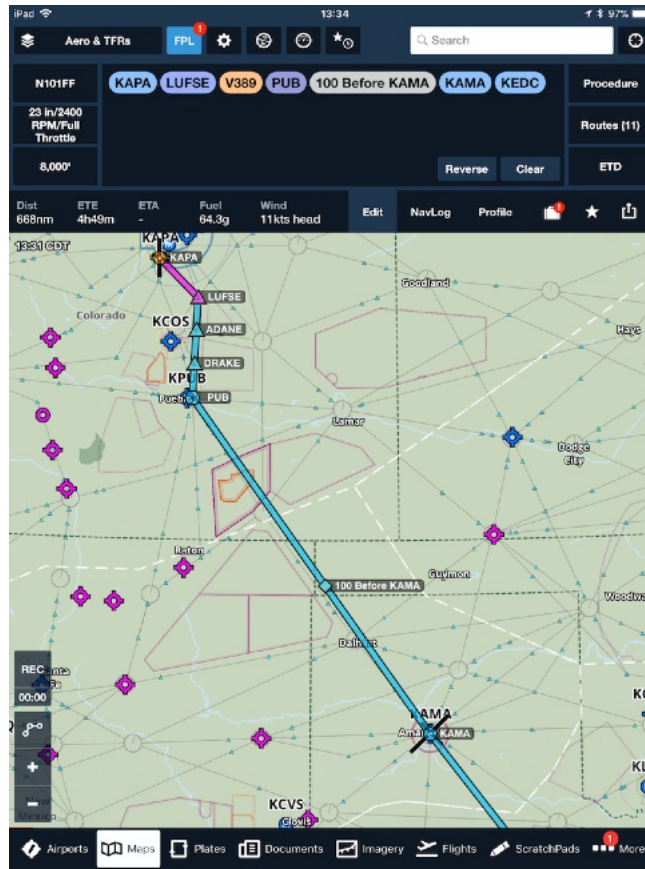

The point is then shown as in the example above “100 Before KAMA”. If you send the route to Flights, that point is then converted into a latitude/longitude coordinate.

Primarily for use by pilots in Europe, the **Set Altitude/Speed** option allows you to specify an altitude, speed, or a Flight Rules change, associated with a particular point in the route. A flight altitude change is **NOT** currently depicted in the Profile view, and altitude and/or speed changes are not shown in the Flights Navlog or used for performance planning. **IMPORTANT:** Altitude/Speed changes are not currently acknowledged by US or Canadian ATC, so for flights in the US or Canada you should file at your proposed cruising altitude and speed.

NavLog View

The navigation log displays each leg of the route, with course (or heading, if winds aloft are included for your route), distance, fuel burn, and time statistics.

The table listing shows the start and end points of each leg, along with the leg statistics. You can select whether to display only Totals columns, only Leg columns or Both Totals and Leg columns (as below) in **More > Settings > Nav Log Columns**.

FROM	TO	HDG	TOTALS			LEG			REMAINING		ETA
● PRUDE	➔ ● JENEY	246°M	68nm	11.5g	0h43m	8nm	1.1g	4m13s	3.3nm	1m25s	19:09
● JENEY	➔ ● MOAKS	246°M	74nm	12.3g	0h46m	6nm	0.8g	3m10s	9.3nm	4m01s	19:11
● MOAKS	➔ ● BRNIE	246°M	75nm	12.6g	0h47m	2nm	0.2g	0m56s	11nm	4m47s	19:12
● BRNIE	➔ ● WISPII	246°M	78nm	12.9g	0h48m	3nm	0.3g	1m20s	14nm	5m53s	19:13
Dist 279nm	ETE 2h38m	ETA(CDT) 21:58	Fuel 39.2g	Wind 21kts head	Edit	NavLog	Profile				

❖ **Planned Data:** Information in the *From, To, Heading (or Course), Totals, and Leg* columns represent the *planned* route and is based on the information provided in the *Search* box, or based on your selected aircraft's performance profile. This information is *not* updated once displayed.

❖ **Real-Time Distance, ETE/ETA:** The *Remaining* and *ETA* columns are updated in real-time based on current GPS position and groundspeed. The distance remaining on the leg, estimated time enroute for the leg, and estimated time of arrival at the next waypoint are displayed.

NOTE: during pre-flight planning on the ground, the *Remaining* and *ETA* columns will not show accurate information, because they require actual (real-time) GPS speed and position to update.

Tap on a waypoint ID in the table to jump to that waypoint on the map.

Tap the arrow button  to adjust your route to any leg, or direct to a waypoint on a leg.

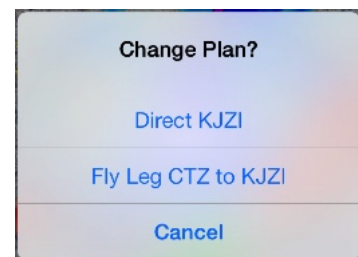

Profile View

While planning your flight, the Profile view (iPad only, Pro or greater subscription required) shows a cross section with your planned altitude (including climb and descent) relative to the controlled airspace, MOA, SUA, and TFRs within 1nm of your planned route (requires iOS 11) as well as terrain and obstacles within a selectable-width corridor along your planned route of flight (default is 2nm-wide: 1nm on either side). In flight, the Profile view automatically switches to show airspace, obstacles and terrain 50nm ahead of your current location. US Obstacle and Terrain data must be downloaded to the iPad to use Profile view.

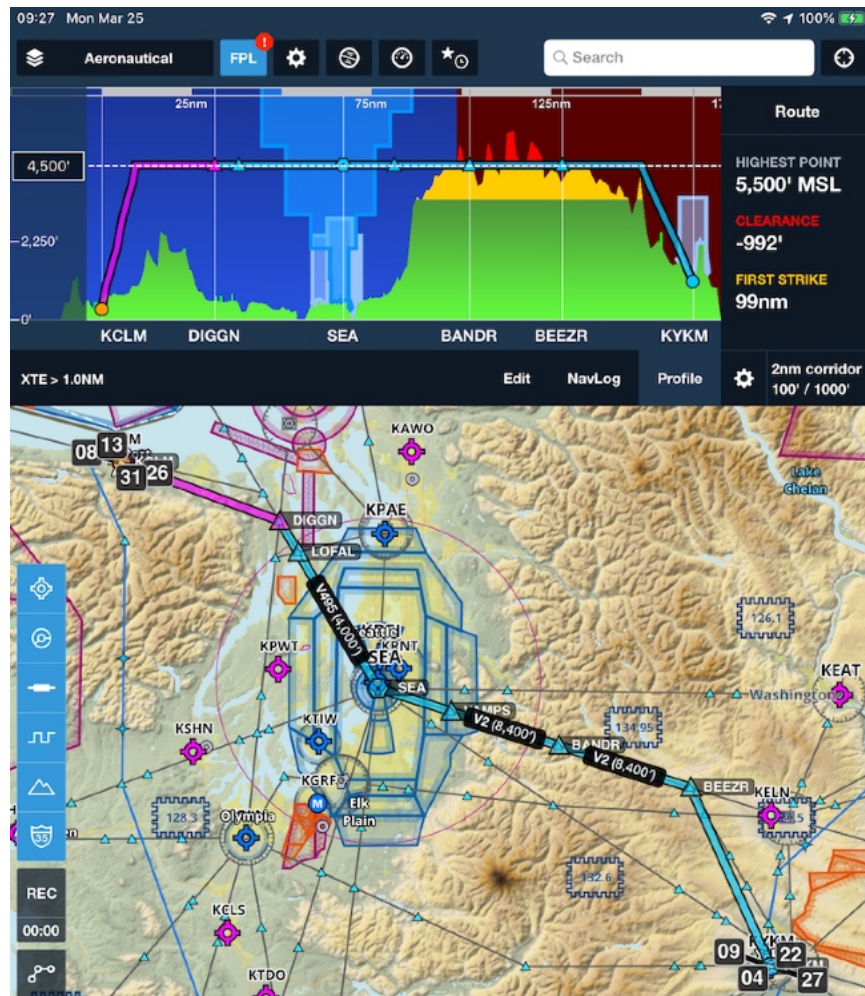

By default, the terrain profile is colored **green** in areas where there is more than 1000' clearance between your planned altitude (or actual altitude while airborne) and terrain/obstacles. The terrain profile changes to **yellow** for those areas where the terrain/obstacle clearance is between 100' and 1,000'. The terrain profile changes to

red in those areas where there is less than 100' terrain/obstacle clearance or where the terrain/obstacle is above your planned or actual altitude.

After you enter a route in the Route Editor, tap the Profile button at the bottom of the Flight Plan Editor to display a cross-section of the terrain and obstacles along the chosen route.

The climb and descent profiles are based on the performance profile selected for the specified aircraft.

Waypoints along your route are depicted as thin vertical white lines with the waypoint identifier displayed along the bottom of the profile view beneath the vertical line.

Adjust the planned altitude by touching the altitude block on the left side of the Profile view and sliding it up or down as desired. If your proposed altitude along your route intersects an obstacle or terrain ahead, the sky area will change from **Blue** to **Red**, the Clearance numbers will display in **Red**, and the First Strike section will indicate how far away (in nautical miles) from your present position the conflicting terrain or obstacle will intersect with your proposed altitude.

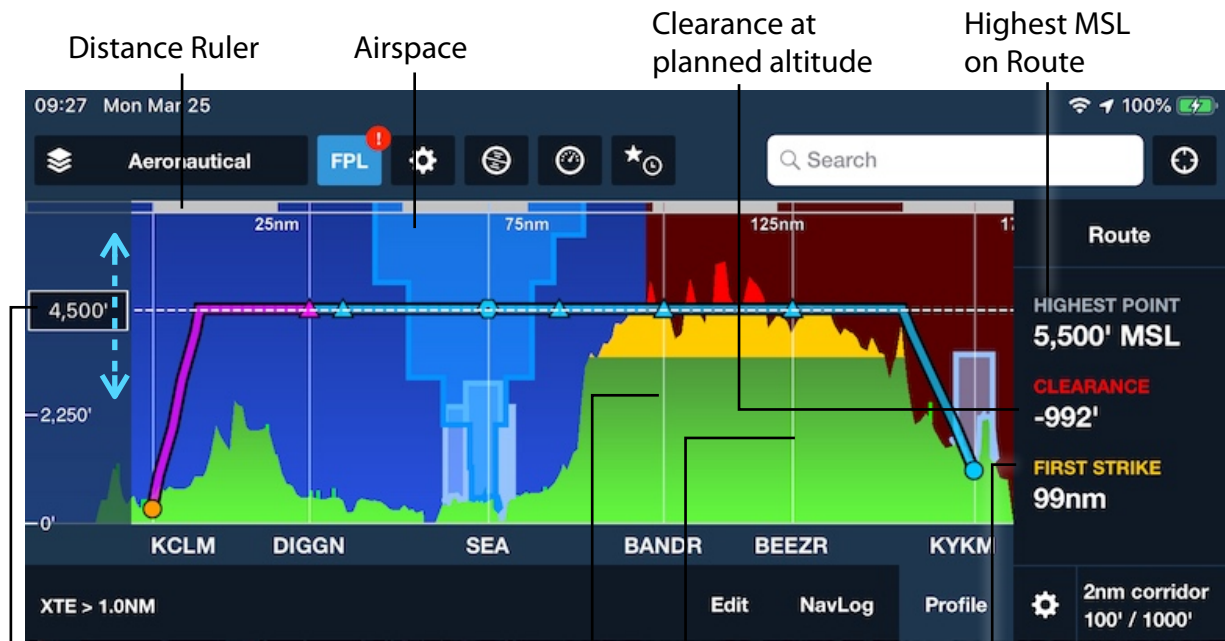

Planned altitude: touch-hold, slide up/down to change

Route waypoints

Distance to first possible terrain/obstacle strike

If the route is in the US, you will also see obstacles depicted along the route as thicker vertical lines. The obstacles are displayed to scale based on their altitude AGL.

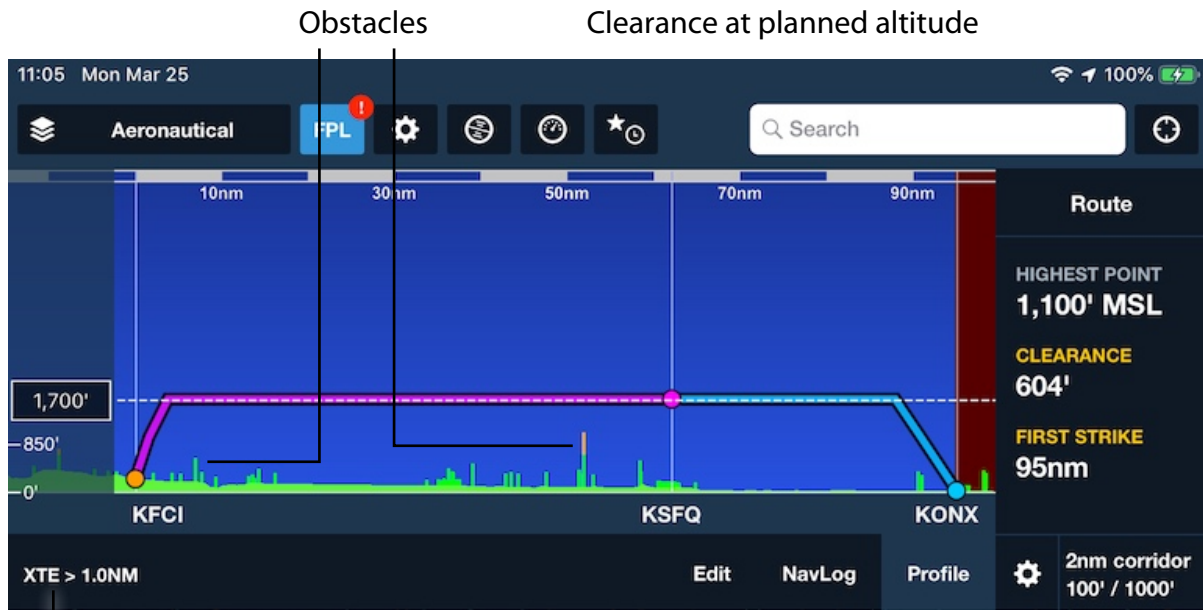

— Cross Track Error > 1.0NM: Indication that the aircraft's position is currently outside the route corridor (2nm corridor)

Corridor Width / Alert Altitudes

Tap the gear button to the right of Profile to choose different total corridor widths. Any obstacle or terrain feature within the selected corridor width centered on the route will be shown on the Profile view.

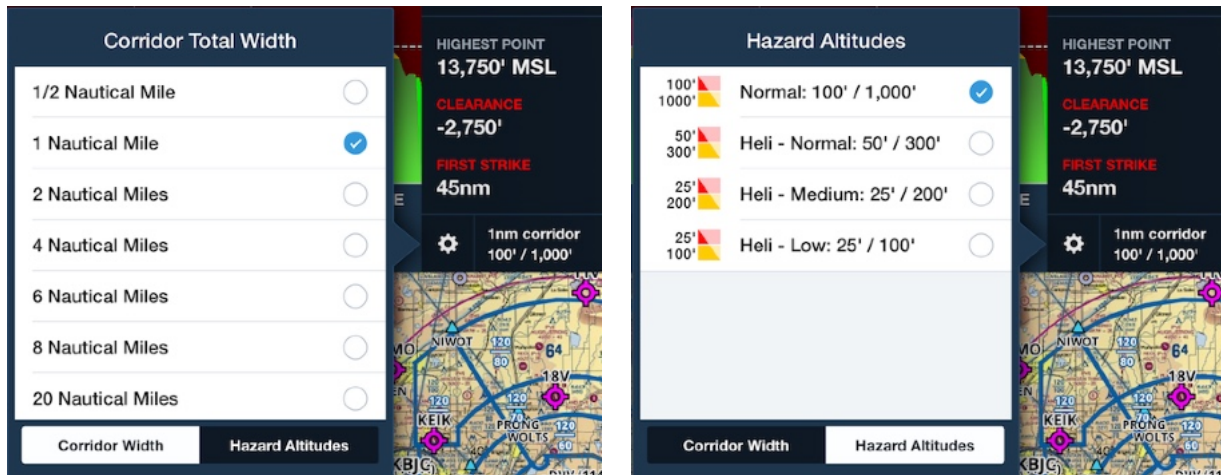

Choose the Hazard Altitude to select the relative altitudes from your aircraft for terrain & obstacle yellow & red warnings for the Profile view and Hazard Advisor.

Zoom in/out

The default Profile view automatically scales to show your entire route. To zoom in on an area of interest, touch two fingers to the Profile view then slide them apart horizontally. Pinch them together to zoom out.

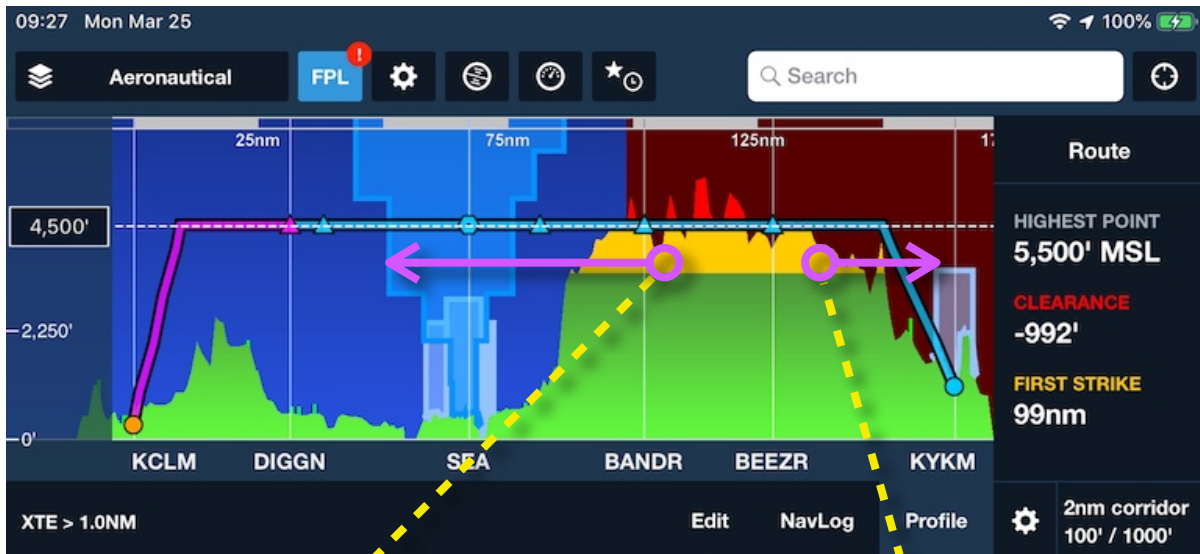

Slide two fingers apart horizontally in the Profile view to zoom in

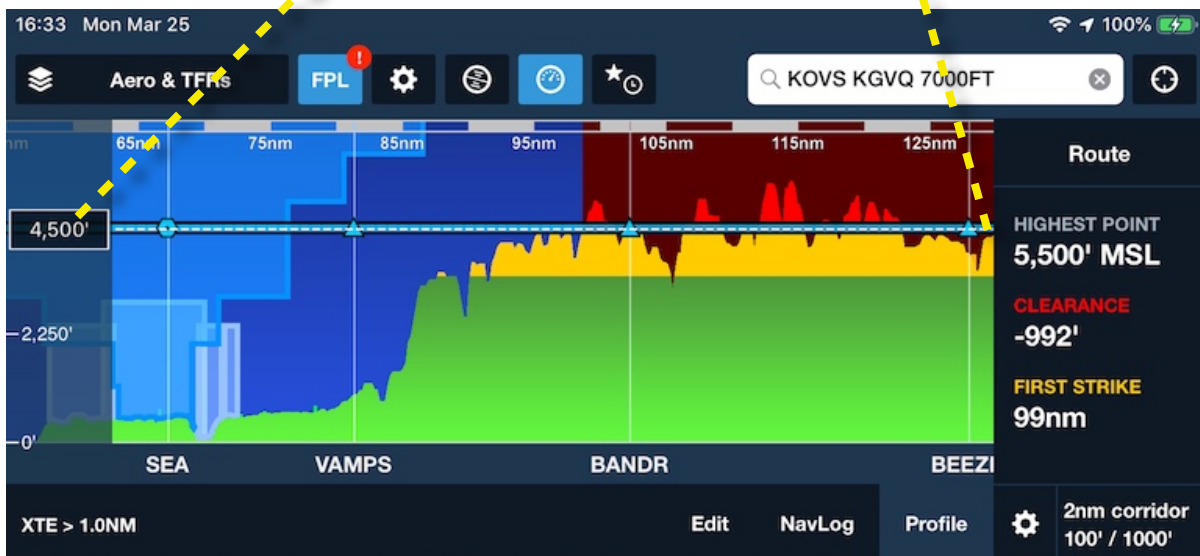

Tap or use "scrubbing" to see airspace details

Tap on an airspace in the Profile view to see details; the map view then zooms-in and highlights the selected airspace. Scrub (drag) a finger left or right across the Profile view to view airspace at that point.

Tap to see airspace details

NOTE: Map view auto-zooms to show highlighted airspace

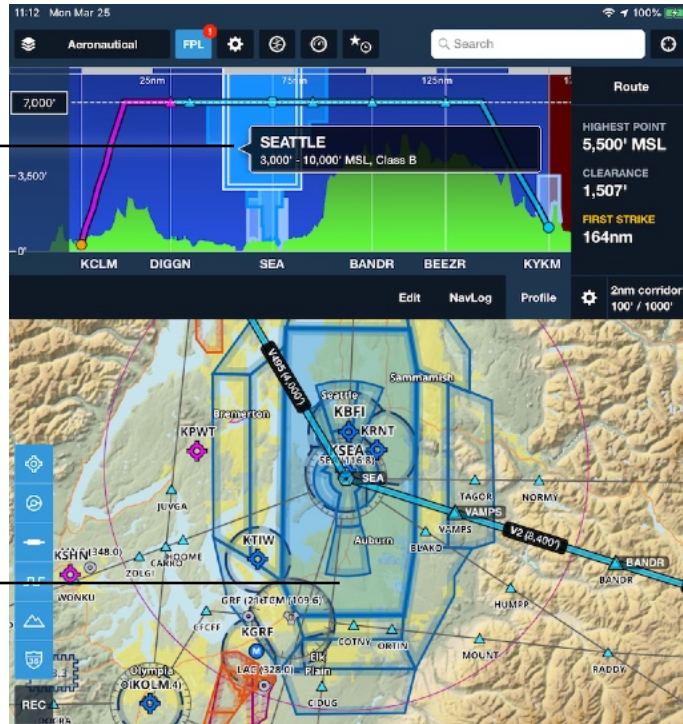

Touch and Scrub (drag) 1 finger across profile to highlight Airspace along route, and see terrain altitude, clearance, and distance from origin

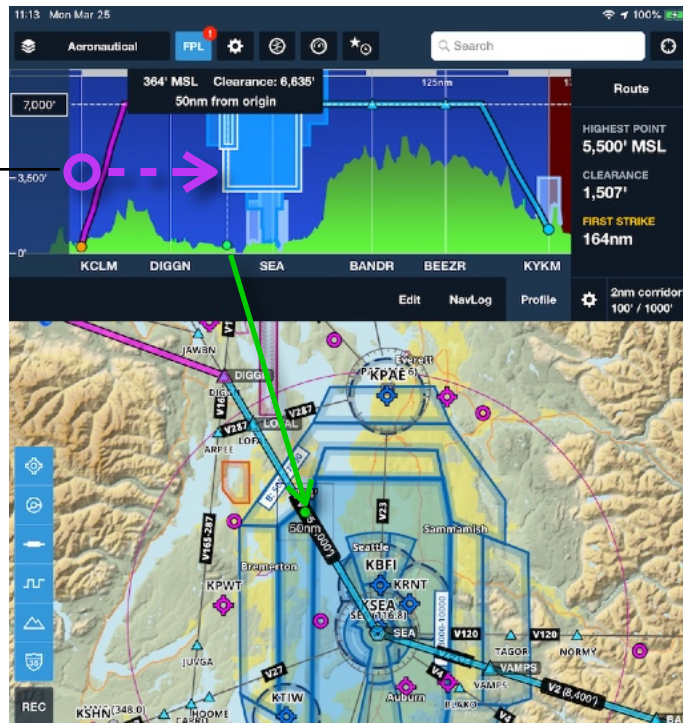

Show altitude by "scrubbing"

Touch and hold a single finger anywhere in the Profile view to open a popup display with altitude and clearance details for that point. A colored icon (dot) is displayed along the route line at that location. The dot's color reflects the amount of terrain clearance based on the profile corridor and altitudes selected. Touch and scrub (drag) a finger left or right across the Profile view to view the altitude and distance from origin at that point.

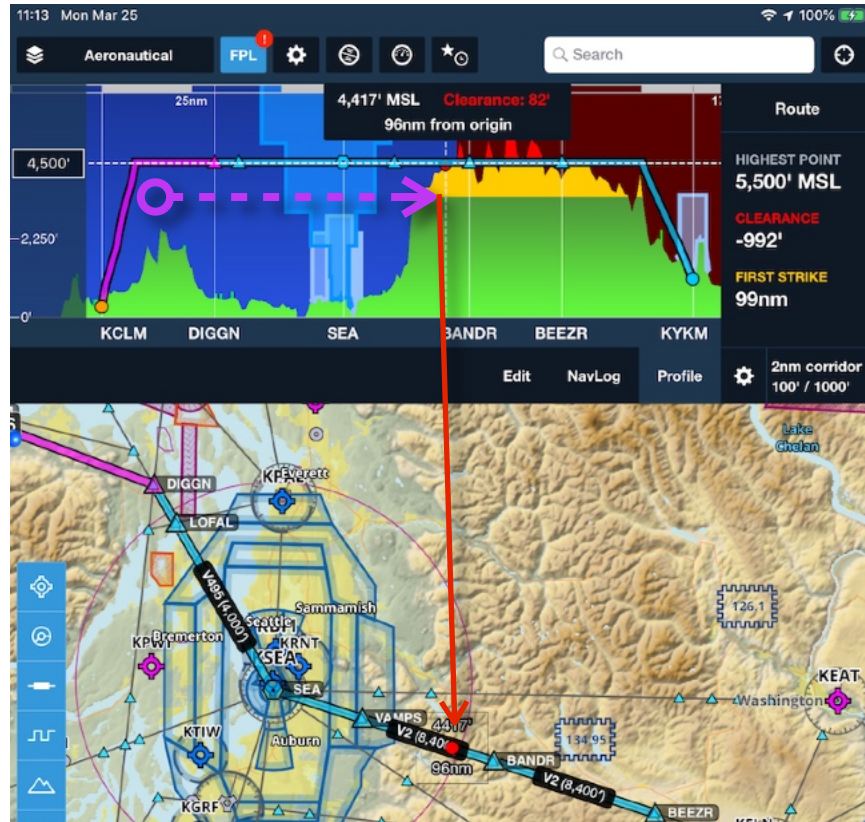

Ruler

When you touch two fingers to the Maps page to display the ruler, the Profile view changes to display the airspace, obstacles, and terrain information under the ruler. You can also “scrub” along the Profile view to see the airspace details, altitude, and terrain clearance popup for the area corresponding to points along the ruler’s path.

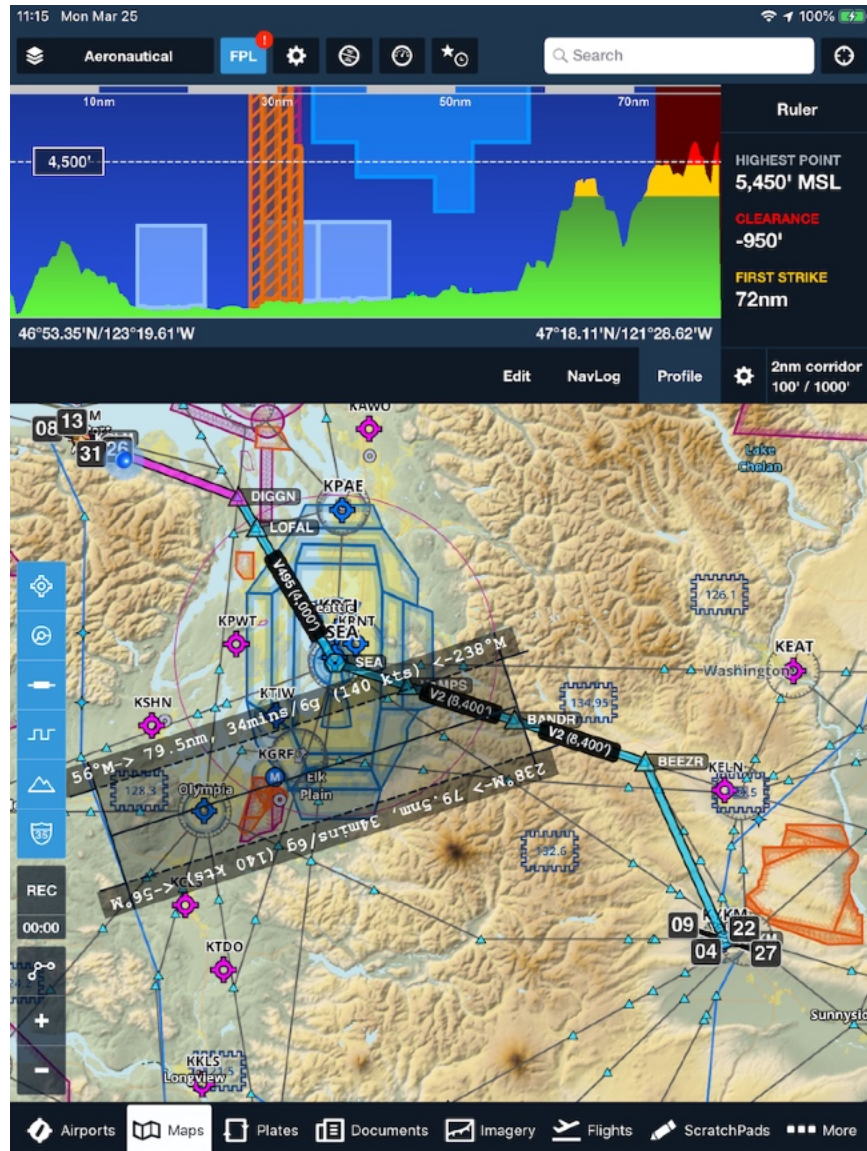

Single-tap on the Maps page to remove the ruler and return to the Route/Flight Profile view.

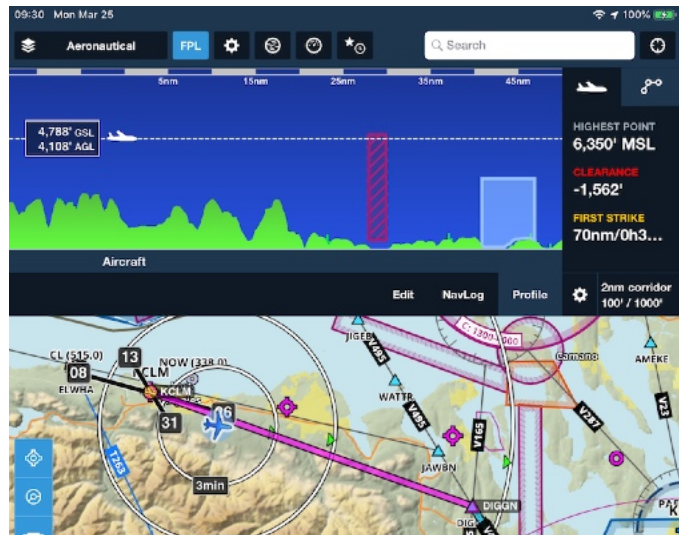

Aircraft view in flight

In flight, the Profile view automatically changes to “Aircraft” mode  which shows airspace, obstacles, and terrain 50nm ahead of your present location, and your GPS altitude (MSL and AGL) to the left of the aircraft icon.



Tap the “Route” button  to show your aircraft’s current position in the climb, cruise, or descent, along with the planned route and altitude in the Profile view. Tap the “Aircraft” button  to return to the aircraft view mode.

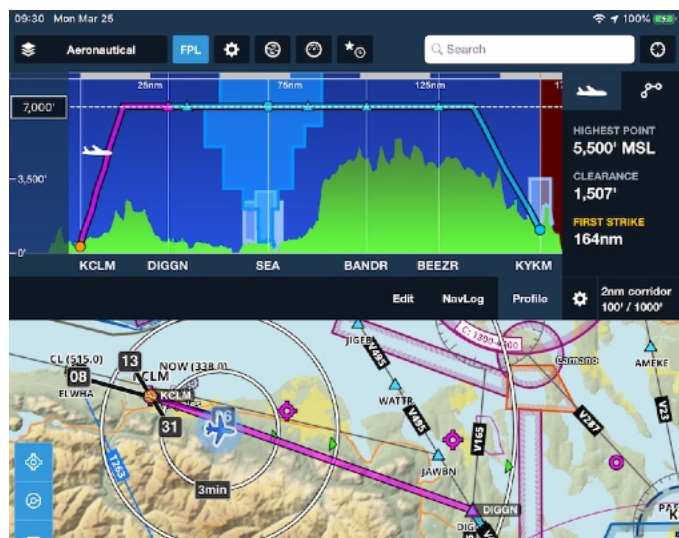

Tap an airspace in the Profile view to highlight it on the Maps page. NOTE: If [Automatic Airspace Highlighting](#) is turned-on, areas of airspace are automatically highlighted or dimmed depending on whether they’re near your current track and altitude.

Single-waypoint Search

To find out about another waypoint, airport or navaid that is not on the active route in the Route Editor, simply enter the waypoint, airport or navaid into the Search box. The route will remain active, but the searched-for item will be highlighted on the screen. You can explore that waypoint (such as viewing an airport's details in a popover view) without affecting the active route, and you can also add it to the route as you would any other location on the map.

Engaging the Moving Map

When the aircraft is not in motion, the current location is shown as a blue dot. When the aircraft is in motion, the current location is shown as an aircraft, which is selected in the **More** > **Settings** view. If the aircraft doesn't show up on the Map, please review the GPS troubleshooting tips on our web site at www.foreflight.com/support/gps

The map can be set to automatically scroll to keep the current location on the screen. Activate this auto-centering mode by tapping the crosshair button in the top right of the screen, in the gray toolbar. The button turns blue when auto-centering is engaged.

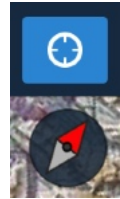

Track Up



Auto-centering can be set to operate in Track Up mode (the top of the screen is rotated to your current GPS track direction), Track Up Forward mode (Track Up mode with the aircraft moved slightly down the screen) and North Up mode. Change modes by tapping the "configure" button with the gear icon in the Maps toolbar. You can also quickly toggle between North Up and your last Track Up mode by tapping the circular "orientation" button just under the auto-center button.

NOTE: If Track-up is selected while stationary, the map will not rotate. Once the aircraft starts moving, the map will rotate so the direction of travel is at the top of the map.

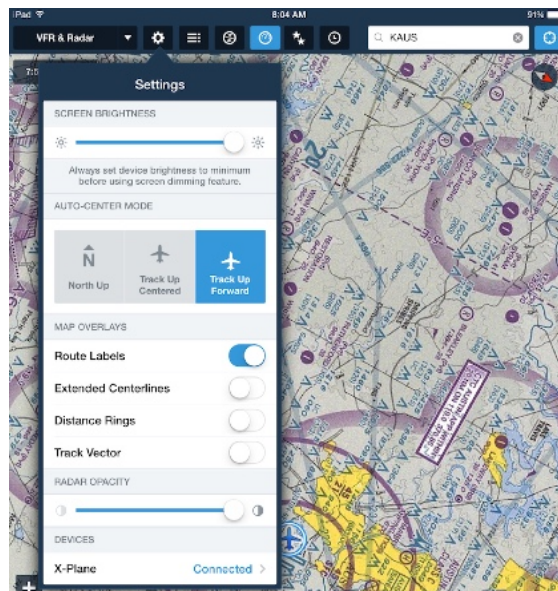
Tap the gear icon in the Maps toolbar to display Settings, then choose Auto-center Mode: North Up Track Up Centered Track Up Forward



Tap the crosshair button to engage Track Up

Tap the orientation button to toggle between Track Up:  and North Up: 

Tap the crosshair button again or manually pan or zoom the map to disable the auto-centering mode. If you pan the map while in track-up mode the current map rotation will be maintained until you tap the auto-center or orientation button in the upper right of the Maps view.

You can prevent the automatic disabling of auto-center mode when panning by changing the Auto Center Deactivate mode in Settings. When that is set to Manual, you cannot pan the map when auto-center mode is ON. Tap the crosshair button to turn auto-center mode OFF so you can pan the map.

Note that only the iPad Cellular model contains a GPS receiver. The Wi-Fi-only iPad does not contain a GPS receiver. In order to use the mobile map functionality with a Wi-Fi-only iPad, you must use use a Sentry or other ADS-B + GPS receiver or an external GPS receiver (see: www.foreflight.com/support/gps).

Distance Rings

Distance Rings displays 3 concentric rings with markers around your aircraft's current position, so you can quickly judge the distance or time from your location to other locations on the chart.

The small green triangles on the rings align with your track and the ring scale labels (either nm or time) align with your right wing.



To display the Distance Rings, tap the Map Settings “gear” button to display the drop-down menu, then slide the Distance Rings switch ON or OFF, or change the setting in **More > Settings**.

As you zoom out on the Map the inner rings and scale markers automatically hide to de-clutter the view.

The 3 concentric Distance Rings can be displayed in several styles, selected by tapping a Distance Ring label (see below) or in **More > Settings**.

Automatic	Distance	Time
NM, ring scales adjust automatically as the map is zoomed in and out	5, 10, 15 NM	5, 10, 30 minutes
	10, 20, 50 NM	10, 20, 60 minutes
	20, 40, 100 NM	

If an Automatic or Distance-based measurement is selected, the rings are only displayed if you have a GPS fix. If a Time-based measurement is selected, the rings are only displayed when you have a GPS fix AND are moving at more than ~10 knots. The rings are hidden when there is no GPS fix, or when moving at less than ~10 knots when a Time-based measurement selected.

To change between Distance Ring types, tap any of the labels attached to a ring and choose the desired style from the pop-up:

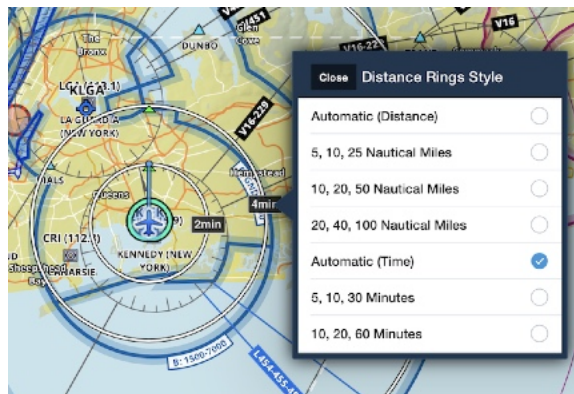

Glide Advisor™

The Glide Advisor uses your aircraft's glide ratio, current GPS altitude AGL, surrounding terrain height, and winds aloft (either Packed before your flight, or updated in-flight via ADS-B or SiriusXM) to present a continually-updated ring showing your glide range. **IMPORTANT:** Prior to use, Glide Advisor must be configured with your aircraft's best glide speed and glide ratio (see below).

The Glide Advisor ring shows when your GPS altitude is more than 200' AGL. When the Glide Advisor ring is displayed, the parameters are shown in the lower-right corner of the Maps page. If you have entered glide information for each aircraft (see below), the N-number of the selected aircraft is also shown for quick verification that the correct parameters are being used.

Glide: 70KIAS, 8.0:1

Glide: 70KIAS, 7.9:1 (N101FF)

In the examples below note the difference between the Glide Advisor ring shape in relatively flat terrain, vs. rising terrain, where the ring shape appears irregular due to the height of the surrounding terrain. In these examples the ring is not centered on the aircraft's position due to the effect of winds.

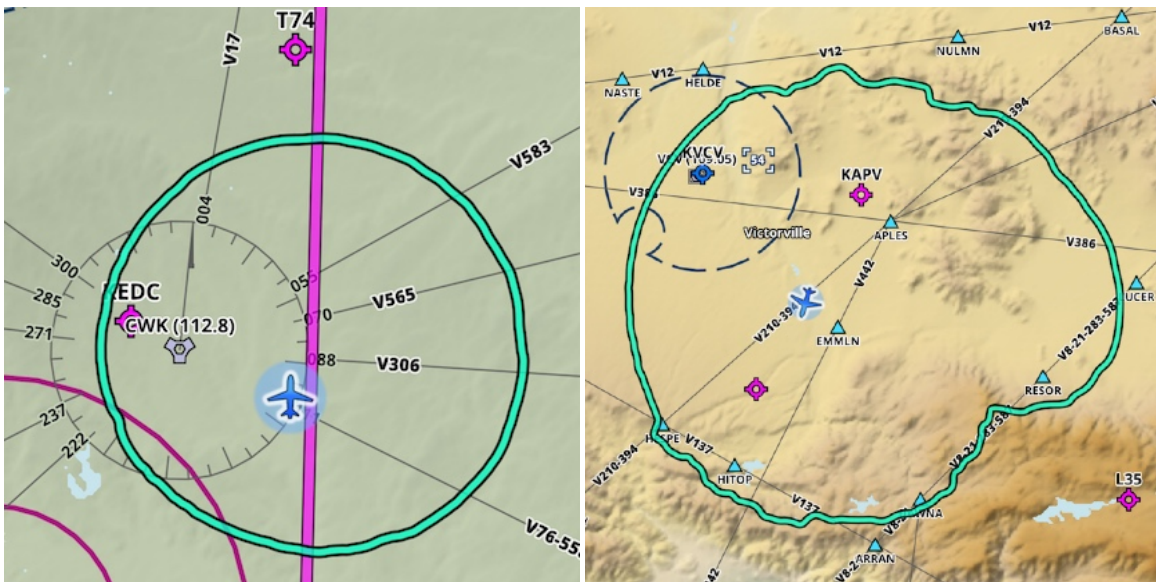

At 6,500' AGL, flat terrain ahead.

At 12,500' AGL, rising terrain ahead

Before using the Glide Advisor, you must enter the best glide speed and best glide ratio for the aircraft you are flying. It is recommended that you take a few minutes to look-up and enter this information for each of the aircraft you fly so that you can display a correct Glide Advisor ring. Best glide speed and glide ratio information can

be found in your aircraft's POH. You can enter this information in [More > Aircraft](#), or you can enter it on the Maps page in the Maps Settings menu:

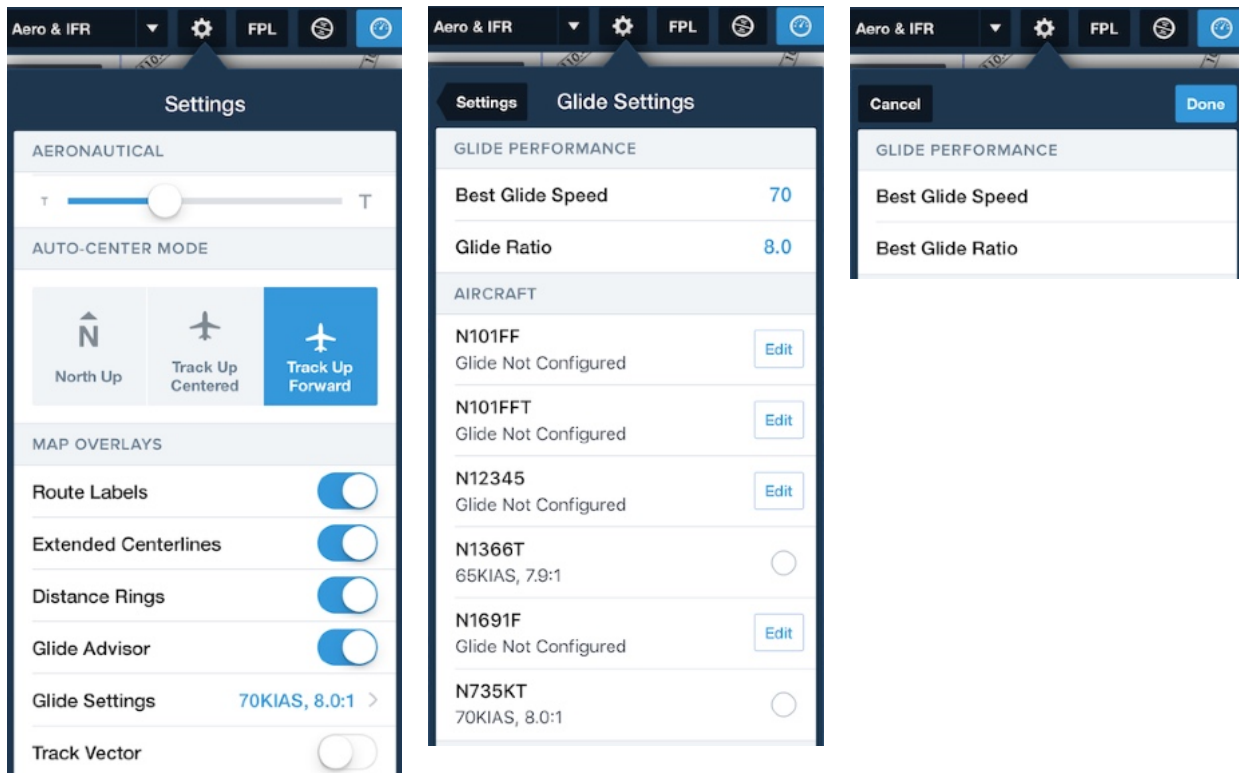

Glide Advisor requires that your aircraft's glide ratio be entered in a form like "8.0:1", meaning that you can glide 8 feet forward for each vertical foot lost - in this case you can simply enter "8.0" in the glide ratio field. However, many POHs express glide ratio in a form like "1.3 nautical miles per 1000 feet", so to get the glide ratio into the proper form you would need to multiply 1.3 by the number of feet in a nautical mile (6,076.12) and divide by 1000. Most glide ratios for powered, fixed-wing aircraft (excluding gliders) fall somewhere between 5 and 15, so if your glide ratio appears to be much smaller or larger than this, double-check your math.

Track Vector

When the Track Vector is ON, a projected track is displayed in front of the aircraft icon. The length of the vector is controlled by the setting on the More page under Settings, and can be 15, 30, 45, 60 seconds; 2, 5, 10 minutes or 1/2, 1, 2, 5, 10, 25, 50 Nautical Miles.

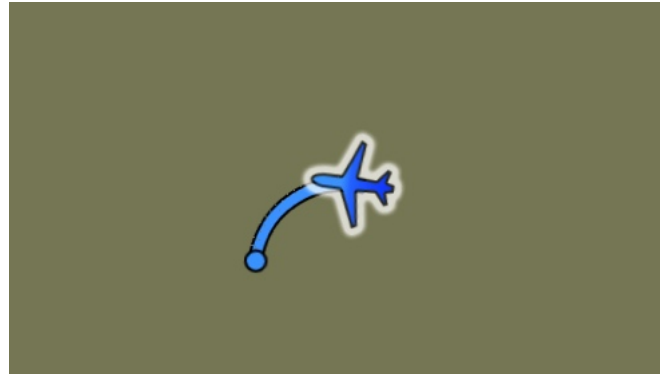
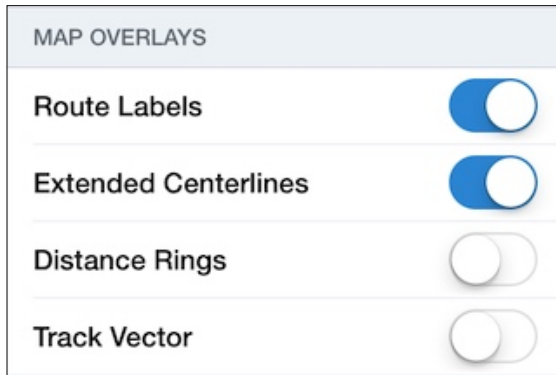

While your track direction is changing at more than 2 degrees-per-second (i.e., the aircraft is turning) the track vector changes to a curve in the direction of your turn.

Direct-To

To create a direct-to change to your route, tap a waypoint on the route. Then tap the orange **Direct To** button. An alternate method is to tap the arrow icon  in the NavLog, or to tap the colored oval in the Route Editor and choose **Direct To**.

Choosing **Direct To** removes all waypoints in the route prior to the selected waypoint and adds a new direct-to leg from present position to the selected waypoint.

Additionally, a direct-to change can be made to utilize a waypoint not already in the route. See the "Touch Planning" section for details.

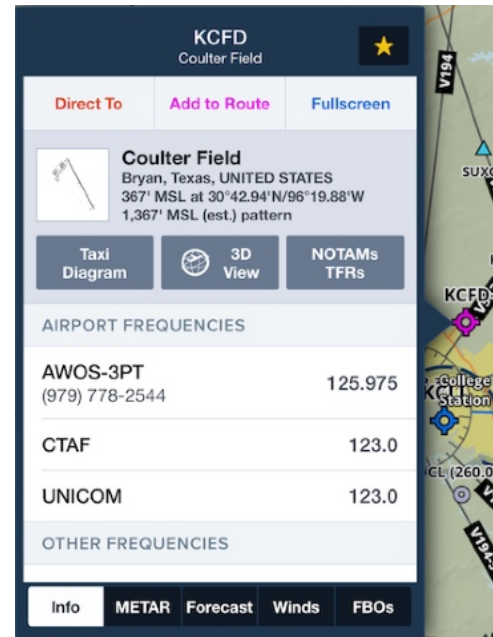

Ruler

Distances can be measured on the Maps view at any time by holding down two fingers on the map until the ruler appears. Hold both fingers on the Map and slide them across the map to reposition the ruler to take measurements between other locations. The ruler is also handy for quickly visualizing great-circle (direct) routes between two points. When measuring distances less than three nautical miles the distance will also be displayed in feet, helpful for measuring available runway.

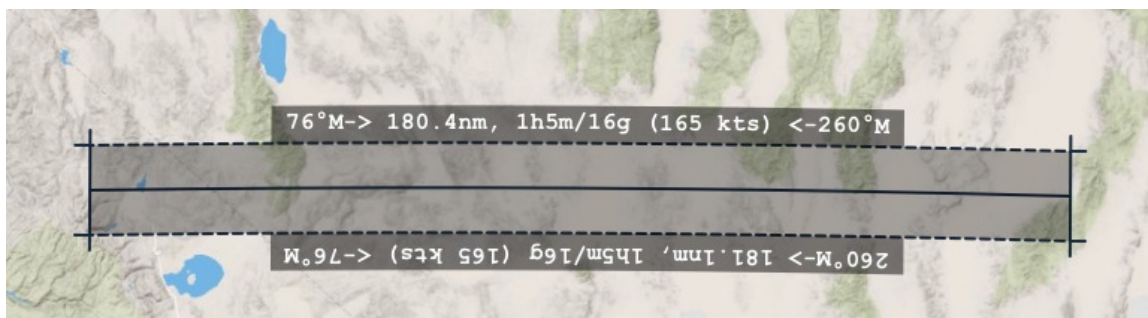

When using the ruler in flight, the current groundspeed will be used to show the time of travel for the distance measured. When not in flight, the TAS from your current route or default aircraft will be used instead.

Fuel burn estimates are also shown using the fuel burn provided for the current route or from the default aircraft. All time and fuel estimates are based on no-wind conditions. Initial course bearings are also shown from each side of the ruler.

The ruler will remain on the Map after you remove your fingers. To remove the ruler, tap on the Map.

Viewing and Hiding the Instrument Panel

To show or hide the Instrument Panel, tap the “instrument” button.



When a position fix is available, the instruments in the Instrument Panel at the bottom of the map update to reflect the latest values for groundspeed, track, and geometric MSL altitude. Additionally, an accuracy value is provided as an indication of the quality of the fix (lower numbers are better).

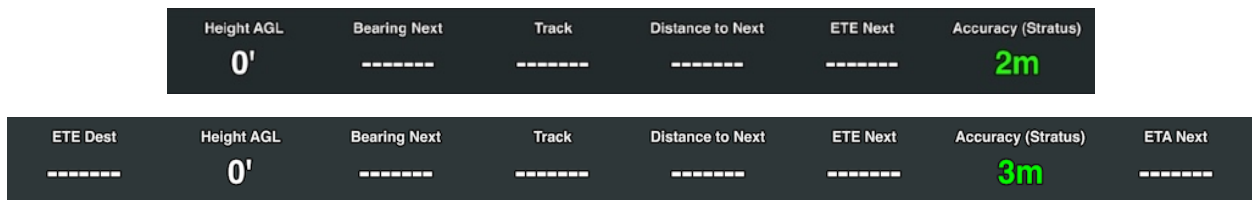

On the iPad, 6 instruments are displayed in the Instrument Panel in portrait orientation and 8 in landscape orientation. On iPhones, 4-5 instruments are displayed in portrait and 6-8 in landscape, based on the iPhone’s size.

The instruments on the right and left ends of the Instrument Panel in Landscape mode are hidden when the device is rotated to Portrait. The default instruments displayed in the Instrument Panel can be replaced with an instrument of your choice by tapping an instrument and selecting a new one from the popup list.

The *Select Instrument* popup displays all available instruments. Be sure to scroll the list up/down to see each instrument. The list provides a description of each instrument’s function, as well as an indication of which ones are already displayed. **NOTE:** When in Portrait orientation, the 2 additional instruments visible in Landscape are shown as being “(already shown)” even though they are not visible on the screen.

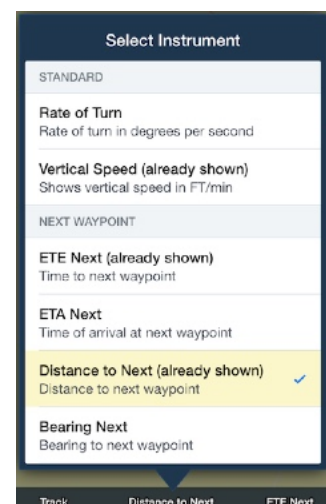

The following instruments are available in the Instrument Panel:

Standard	Next Waypoint	Destination	Other
Groundspeed	ETE Next	ETE Dest	Current Lat/Lon
GPS Altitude	ETA Next	ETA Dest	Zulu Time
Pressure Altitude	Distance to Next	Distance to Dest	Horizon Distance
Cabin Pressure	Bearing Next	Bearing to Dest	Blank
Height AGL #	Course Next	Descent to Dest	Flight Time
Height MEF #	Cross Track Error		
Track	Nearest Airport		
Accuracy	Nearest Navaid		
Rate of Turn			
Vertical Speed			
Climb Gradient			
Nearest Baro			

Pressure Altitude and **Cabin Pressure** show pressure altitude as derived by a barometric sensor, if present. If the sensor is in your iPad or iPhone, only Cabin Pressure will display a value. If connected to a Sentry or other external device with a built-in barometric sensor, both instruments will show the same value and Pressure Altitude will have an "Uncorrected" label, indicating that the value may not correspond to actual indicated altitude. However, if the "Pressurized Cabin" switch is enabled in the connected device's settings then only the Cabin Pressure instrument will display a value; the Pressure Altitude instrument will be blank. If connected to a source that can provide actual indicated altitude, the Pressure Altitude instrument will display a value with a "Corrected" label. **Note:** if you are using a SatCom Direct router or SDR Gateway, you will need a Performance Plus or Business Performance subscription in order to see Pressure Altitude.

Height AGL shows the GPS altitude above the highest terrain within a 1/4 nm circle around your present location, when moving at 40 kts or greater. #: Pro Plus or Performance Plus subscription required.

Height MEF shows a dynamic Maximum Elevation Figure for a 1/2 degree latitude by 1/2 degree longitude box centered on your aircraft's location, when moving at 40

kts or greater. MEF is calculated as: the tallest obstacle or terrain in that box, rounded up to the nearest 200 feet.

#: Pro Plus or Performance Plus subscription required.

Nearest Airport shows the Cardinal position and distance from the nearest airport to your present location.

Nearest Navaid shows the Navaid identifier and the radial and distance from that Navaid.

Nearest Baro shows the altimeter baro setting for the closest reporting airport, if recent METAR information is available.

Horizon Distance calculates the estimated distance to the horizon in nm based on your present altitude AGL, assuming a simplified, spherical model of the earth.

Flight Time shows the total flight time while recording a Track Log. See [Flight Time Instrument](#) for more information.

Using Favorite and Recent Routes

To view a Favorite or Recent route, tap the star/clock button  in the dark blue tool bar at the top of the Maps view to display a pop-up that shows a list of Favorite & Recent routes, selectable by tapping the Favorites or Recents buttons.

Tap a Recent or Favorite route to make it the active route.

To delete a route from the list, swipe-to-delete (swipe your finger from right to left) across the route, then tap the red "Delete" button. You can delete all routes from the Recents list by tapping the **Clear** button at the top of the list.

The Favorites list can be re-ordered by tapping the **Edit** button. Once in *Edit* mode a three-bar icon is displayed on the right of each route in the list. Touch-and-hold on a three bar icon until the row appears to lift up, then drag the row up or down to the desired location in the list. You can also delete the route by tapping the red button on the left.

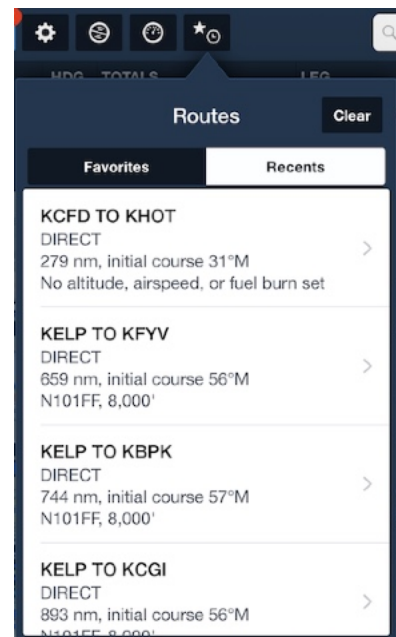

Favorite and Recent Route Sync

Changes to your Favorite and Recent routes, including adding, removing and change the order of the routes, are automatically synchronized to each device that is signed-in to your ForeFlight Mobile account. For more information, see the [Sync chapter](#).

Clearing a Route

Clear a route from the Map by tapping the “Clear” button in the Route Editor. Tap the Flight Plan Editor “FPL” button (bright blue in top-middle of this screenshot) to show the Route Editor:

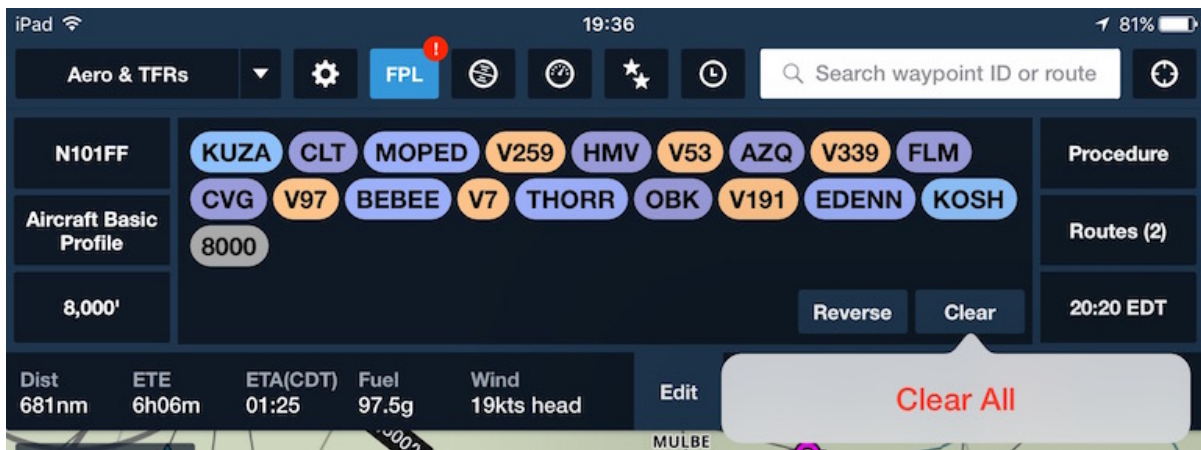

Alerts

About The Design

ForeFlight Mobile provides a number of in-app audio and visual alerts that help to keep pilots aware of potential hazards and improve situational awareness in flight and on the ground. Alerts appear in red or beige rectangles in the upper third of the screen and persist for several seconds; they can be dismissed more quickly by tapping on them. Audio alerts can be silenced, and individual alerts disabled entirely in **More > Settings > Alerts**.

Runway Proximity Advisor

ForeFlight Mobile has a visual and audio alert system that triggers when you taxi near or onto a runway. This system uses GPS and geographic runway safety areas to alert pilots as they approach or enter a runway environment. This feature is available for all ForeFlight subscriptions.

The system runs automatically in the background, regardless of which part of the app is currently visible. ForeFlight Mobile must be running and visible on the iPad screen for the system to function. Essentially all airports in the USA are supported.

As you near the runway the system will provide an “Approaching” alert which includes the name of the runway. Upon entering the runway itself, the system will provide an “Entered” alert, which includes both the name of the runway and the length of runway remaining in feet, rounded to the nearest hundred. If the aircraft is not clearly at one particular end of the runway, the system will alert with both runway end names and will not include a length remaining upon entering the runway. For instance, it will say “02-20” instead of just “02.”

To receive audio alerts in your headset, use a bluetooth-capable headset and connect it to the iPad. Ensure that the iPad volume is set to an appropriate and safe level.

If you are using a vibration-capable device, like the iPhone, the device will vibrate when audio alerts are given.

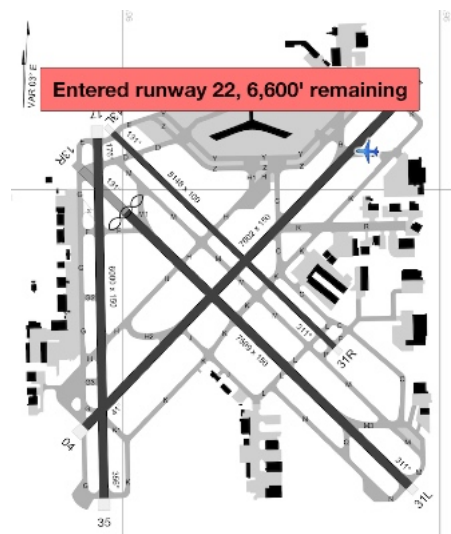

Alerts are automatically disabled when the aircraft is stopped or traveling faster than 40kts. Note that you may receive an alert on take-off if you cross a different runway early in the take-off roll. Similarly, on landing you may receive an alert if you cross another runway while rolling out. You will not be alerted about entering your landing runway when landing - you have to *taxi* onto or near a runway to get an alert.

Cabin Altitude Advisor

If your iPad/iPhone is equipped with a barometric pressure sensor, or is connected to an external device that provides that capability (such as a Sentry or Garmin Flight Stream 210), ForeFlight will monitor your cabin's pressure altitude and provide alerts when you pass 12,000' MSL and 25,000' MSL. Each alert will sound no more than once every 30 minutes.

Caution, cabin altitude above 12,000'

Alert, cabin altitude above 25,000'

Terrain/Obstacle Alerts

When GPS Accuracy is good the Terrain/Obstacle Alert detects and warns of threatening obstacle and terrain using visual and audio alerts that display app-wide, not just on the Maps view. When nearby to airports or approach paths the alert sensitivity automatically adjusts to reduce nuisance alerts.

Tap the "Fullscreen" button and ForeFlight will automatically jump to your position on the Maps view with the Hazard Advisor layer enabled.

Alerts dismiss automatically once the hazard is no longer a threat (e.g. if you turn away from a threat), or tap the "Dismiss" button to clear the alert.

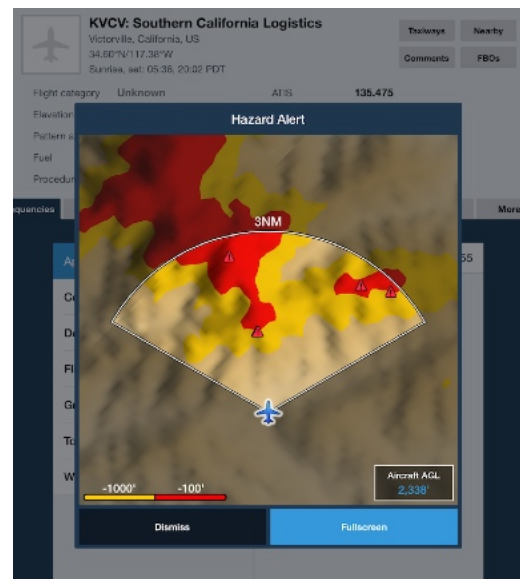

Requires an Pro Plus, Performance Plus, Business Pro, or Business Performance subscription, and that Obstacle data and Terrain data have been downloaded.

You can enable Terrain/Obstacle Alerts in More > Settings > Alerts.

Traffic Alerts

When connected to an external device that provides ADS-B traffic data (such as a Sentry), ForeFlight can issue alerts when another aircraft passes within 1.8NM horizontally and +/- 1,200' vertically of your aircraft's position. See [Traffic Alerts](#) for more information.

TFR Alerts

TFR Alerts monitor your GPS position and track for nearby known TFRs and provide visual and/or audio alerts to warn you if your present track will take you inside (or over/under) a known TFR within the next 5 minutes, even if you don't have the TFR map layer turned on. Four different alerts are possible based on your position relative to the TFR: "TFR Ahead", "TFR Below", "TFR Above", and "Inside TFR."

If ForeFlight detects that you will enter or pass within three nautical miles of an active (or soon-to-be active) TFR within the next five minutes it will issue a "TFR Ahead" alert, or "Upcoming TFR Ahead" if the TFR is not yet active. A TFR's altitude (MSL or AGL) is taken into account when determining if you will enter it, and an adjustable altitude buffer is provided in **More > Settings > Alerts** so you can customize how close your altitude must be to the TFR for the alert to activate.

The altitude buffer has settings for 500', 1000', 2000', and 5000'. If you are outside a TFR's altitude but within the selected buffer altitude, ForeFlight will issue "TFR Below" or "TFR Above" alerts as you pass respectively above or below the TFR. If you enter a TFR within its altitude range ForeFlight will issue an "Inside TFR" alert.

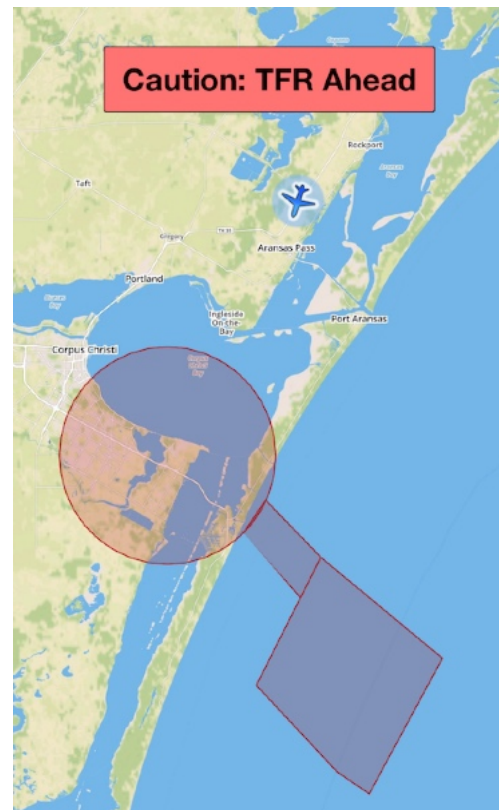

TFR ALERTS IMPORTANT NOTICE:

TFR alerts are provided **only** as a tool to increase situational awareness in flight. They **do not** replace conventional tools and practices for avoiding TFRs and should not be used as such.

ForeFlight can only provide alerts for TFRs that it has information for, which requires you to download that information before flying. Failing to do so may prevent ForeFlight from displaying alerts for active or soon-to-be-active TFRs.

Immediately before your flight: While still connected to the Internet, use the [Pack](#) feature to ensure all relevant TFR and weather data is downloaded. Alerts for TFRs issued **after** you Pack will not be shown, unless you are using an ADS-B or XM in-flight weather receiver.

Sink Rate

The Sink Rate alert warns you when your downward vertical speed exceeds a certain amount, which varies based on your height above ground so as to warn you sooner at lower altitudes.

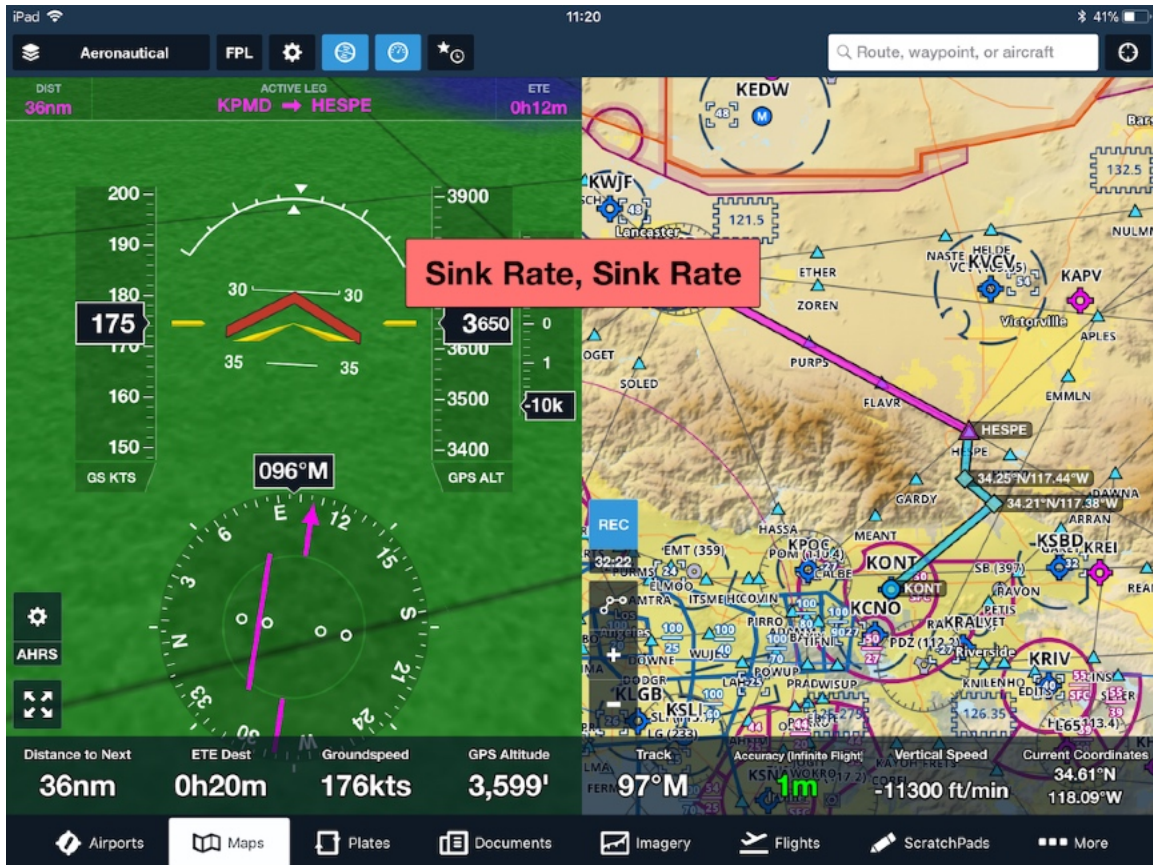

At all altitudes, the descent rate required to trigger the alert must be maintained for five seconds, and the alert will only sound once every 30 seconds. This alert is automatically disabled if your groundspeed is less than 40kts.

Above 2,500' AGL (or when AGL is not known), the alert is triggered if your descent rate exceeds -3,500' per minute.

Between 2,500' AGL and 500' AGL the descent rate required to trigger the alert decreases linearly along with altitude, down to a threshold of -1,500' per minute.

At 500' AGL the alert is triggered if your descent rate exceeds -1,500' per minute.

Runway Final Approach

The Runway Final Approach alert triggers when you are lined up with (meaning your actual track is within $\pm 15^\circ$ of the runway heading) and descending towards a runway, even if the airport isn't in your route. The Runway Final Approach alert will only trigger once every 10 minutes, so may not trigger after the first alert if you're flying multiple approaches in a short traffic pattern.

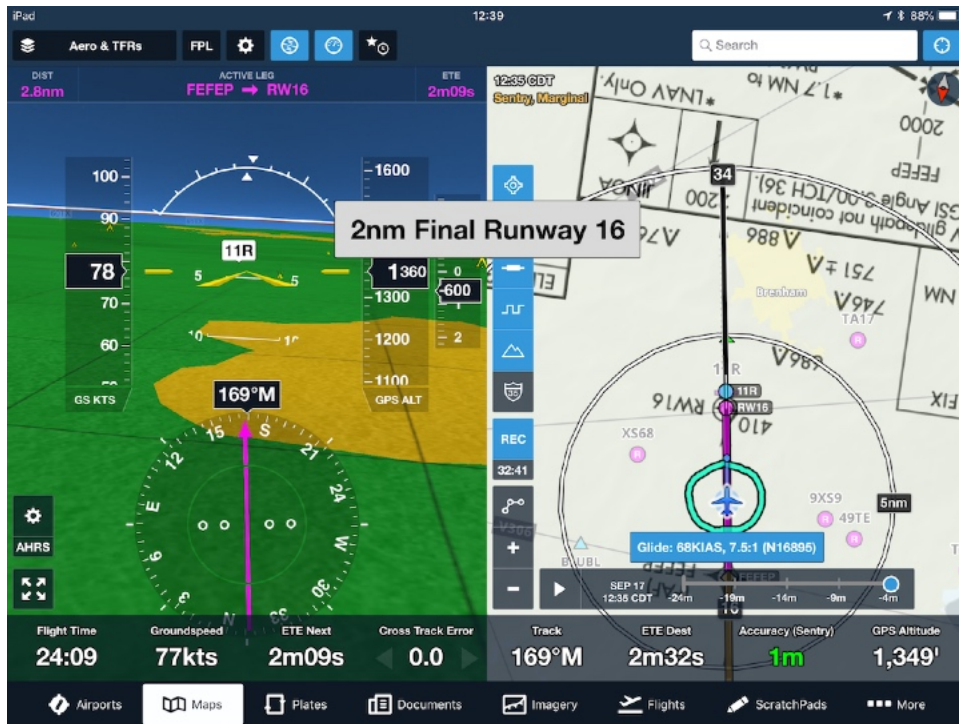

500' AGL

The 500' AGL alert is a simple callout that triggers when you descend through 500' AGL after having been above 1,000' AGL. The alert will only sound once every 60 seconds, and is automatically disabled if your groundspeed is less than 40kts.



Device Disconnect

The Device Disconnect alert is triggered if the Bluetooth or Wi-Fi connection to a portable or panel-mounted device that ForeFlight supports is lost. This allows you to take appropriate action to restore the connection, to switch to a backup device (if available), or to continue the flight knowing that the previously connected device is no longer available. The alert is only triggered if your groundspeed is above 40 knots or if your device does not have a GPS fix.



Destination Weather Frequency

The destination weather frequency callout provides you with your destination airport's weather frequency (whether ATIS, AWOS, or ASOS) as you near the airport.

The callout requires that the last item in your route be an airport (there must be more than one item in your route) and that the airport has a weather frequency. The callout occurs at a certain distance from the airport, which is greater at higher altitudes - at 5,000 feet or below the callout occurs at 20nm from the airport.

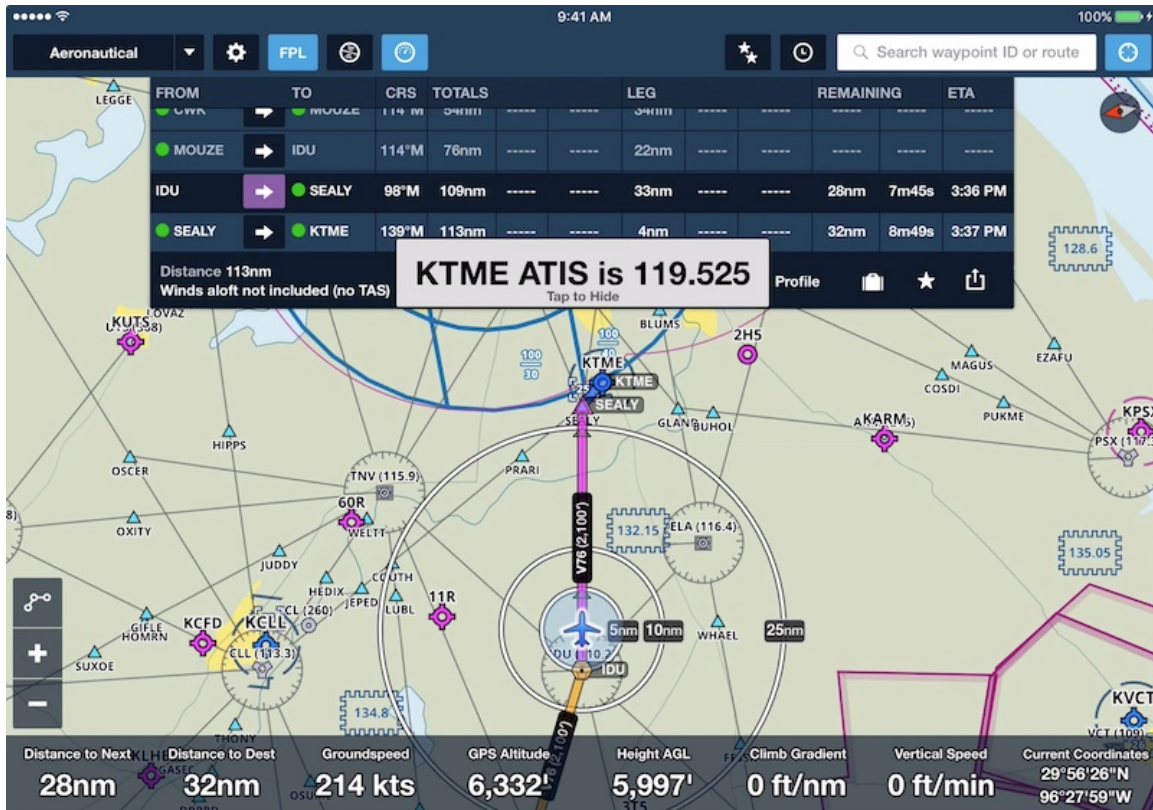

Unlike other alerts, the weather frequency popup does not disappear after a few seconds - it will remain on the screen until you dismiss it by tapping on it.

The callout will not occur more than once every 20 minutes for the same airport, but if you change the destination airport then the callout can occur again in less time for the new airport.

Transition Altitude

The Transition Altitude alert provides an audio and visual callout when you climb or descend through 18,000 feet in the U.S. or Canada (or local transition altitude in Europe). If up-to-date weather data is being received in-flight via ADS-B or XM, the alert also includes the nearest altimeter setting on descent.

New Flight Plan Loaded From Panel

If connected to installed avionics that can send flight plans to ForeFlight (such as Garmin Connex devices), and “Auto-Receive Panel Flight Plans” is enabled in More > Settings, any time ForeFlight receives and loads a new flight plan from the panel it will display a “New Flight Plan Loaded From Panel” message.

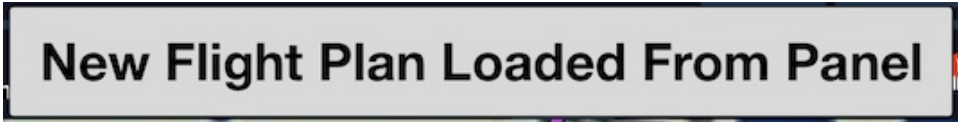

New Flight Plan Loaded From Panel

Low Battery

If connected to a supported portable device (Sentry, Stratus, all supported Garmin portables, and the SiriusXM SXAR1) a Low Battery alert will be displayed when the device’s battery level reaches 20%.



Sentry Battery low: 20%

Pack

About the Design

While connected to the Internet, use Pack to supplement your [Downloads](#) by running a preflight check to ensure you have the information you need for a trip downloaded to your device for offline (inflight) use.

Packed data is not saved somewhere different than you're used to, but is seamlessly integrated with the rest of the data you already have downloaded or are viewing over the Internet. You view the Packed charts, plates, and data as you are used to doing: on the Maps page, Plates page, Airports page, etc...

Charts and plates downloaded using Pack are for the current data cycle only and will not automatically update at the next data cycle.

Pack analyzes your route on the Maps or Flights views by looking at a corridor 50 NM wide (25 NM on each side of your route) and 100 NM in diameter around your departure and destination airports (50 NM from each). Pack will download charts and plates for any states that fall inside the boundary. Beginning with ForeFlight Mobile 10.0, the Pack popup shows a map with the details of the corridor that determines which data will be downloaded.

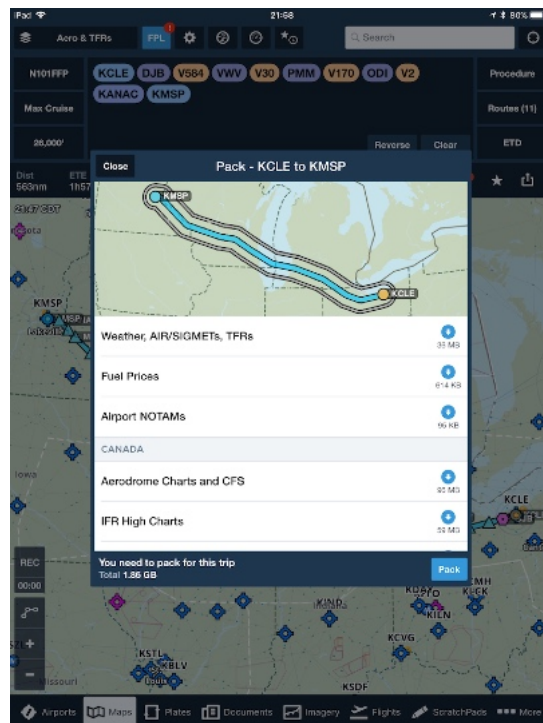

IMPORTANT: Pack only analyzes the charts along your route based on the chart type selections you made in the [Download Settings](#) view. So for example if you are planning a flight above 18,000' be sure you have IFR High Charts turned ON.

Pack also downloads any Weather (METAR, TAF and MOS), AIR/SIGMETs, TFRs and fuel price data inside the 50 NM route corridor and 100 NM diameters departure/destination circles.

If you have an Pro Plus, Performance Plus, or Business Performance subscription plan, Pack will download forecast data for the [Icing](#), [Turbulence](#), and [Surface Analysis](#) layers. If your route of flight stays within the bounds of the U.S.-only layers for icing and turbulence, Pack will only download data for those layers. If your route of flight stays entirely outside the bounds of the U.S.-only layers, Pack will only download data for the Global layers. If your route of flight crosses the boundary, Pack will download data for both the U.S. and Global icing and turbulence layers.

Pack will automatically analyze your route if the Pack "Enable Auto Check" is ON in More > Settings. If it is OFF, Pack will analyze your route only when you tap the Pack button  in the bottom right of the Flight Plan Editor, or tap the Pack line at the bottom of the Flights view.

If Enable Auto Check is ON, Pack periodically re-analyzes the route and will alert you if new items become available. Once you Pack for the trip METAR, TAF and TFR updates will be downloaded automatically, provided the route has not been changed.

Even with Pack, it is a recommended best practice to check that the desired areas have been selected on the [Downloads page](#). This will speed up packing since fewer charts and plates will need to be downloaded when using Pack before a flight.

If your route includes states you have not selected to download in More > Downloads > United States, Pack will download that state's data but the state will not be selected for ongoing downloads (in future data cycles) in More > Downloads > United States. This means that when the next data cycle goes live, the states that were Packed will show as Expired. Clear the message by tapping More > Downloads > Delete > Delete Expired.

Tip: Pack for your flight (see below) once you've finished planning your route to ensure you have the data needed for your flight and so you have time to review relevant TAFs, METARs, NOTAMs, TFRs, etc. Shortly before you head to the plane for the flight, use Pack one more time to make sure you have the latest available data.

Pack for a Flight

After entering a route on the Maps view, Pack analyzes the route to determine if any data needs to be downloaded. If data does need to be downloaded, a red “!” is displayed on both the Pack (suitcase) button and the FPL hide/show button.

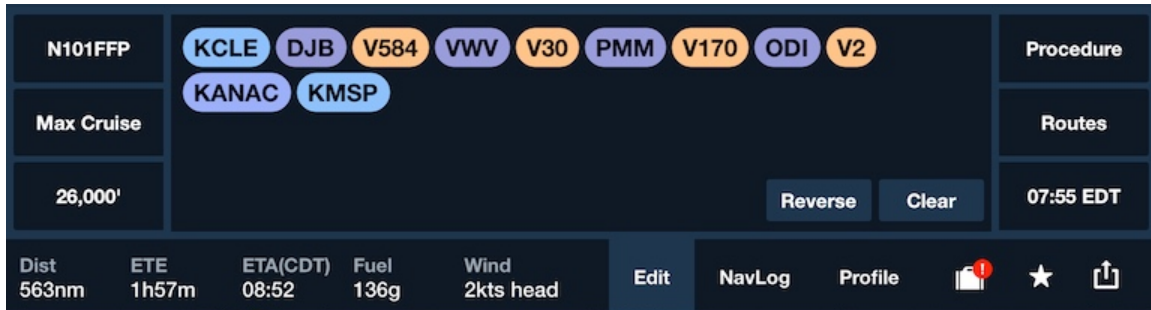

Tap the Pack (suitcase) button in the bottom right of the Flight Plan Editor to open the Pack popup and review the list of needed downloads. On iPhone, the Pack button is located at the bottom of the FPL drawer. An estimate of the amount of data to be downloaded is shown in the lower left corner.

You can also access Pack on the Flights view, near the bottom of the Flight Planning form.

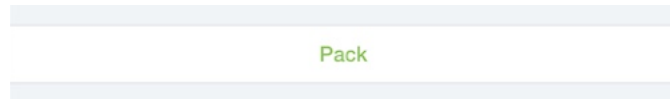

Tap the blue **Pack** button to download all listed items. If you are short on time and only want to download a few items, instead of tapping the Pack button, tap on the blue download arrow next to each item(s) you want to download. **REMEMBER: information you don't download will not be available in flight.**

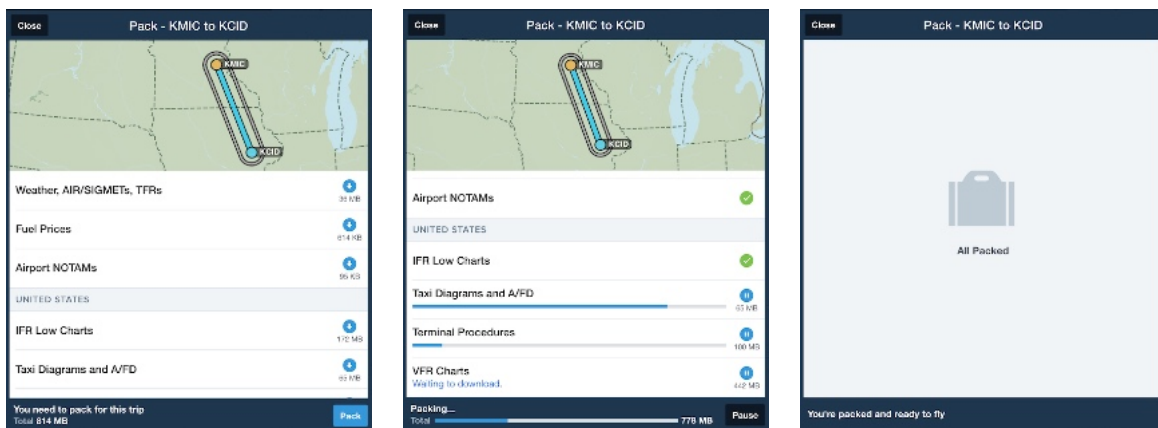

Tap outside the Pack popup to close the popup and continue using ForeFlight while the Pack data is downloading. Tap the Pack button again to open the popup to

check Pack status. When Pack has finished downloading the ! will disappear on the Maps view.

If the route is changed significantly while Packing a route on the Maps view, the Pack downloads will stop automatically.

When Packing on the Flights view you can create other routes on Flights or Maps, and even make changes to the route being Packed without interrupting it. However, the charts and data being Packed will not update automatically if you make any major changes to the route, so you will need to open Pack for it to re-analyze the route and update the list of items to download.

If you tap "Pack" on Flights while Packing a different flight plan, the a pop-up will open to ask you to confirm whether to pause the Pack in Progress. Tap "Cancel" to allow the Pack in Progress to complete, or tap "Pause" to pause it.

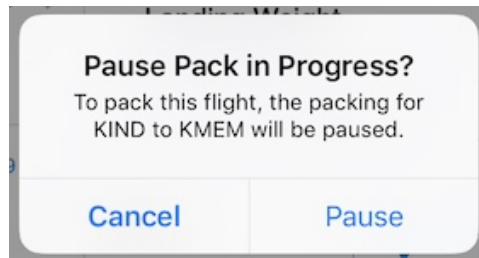

Sync

About the Design

Sync is a fast, cloud-based system that works in the background to synchronize Recent and Favorite Airports, Routes, Weather Imagery, User Waypoints, Aircraft, ScratchPads (iPads only), Flight Plans (both filed and un-filed), Navlogs, Briefings, Documents and annotations, and Weight & Balance profiles between all devices signed-in to your ForeFlight account. Because sync'd information is stored in the cloud, changes made on one device will automatically be delivered to your other internet-connected devices.

IMPORTANT: Sync is disabled by default for multi-pilot accounts with a shared single login.

Using Sync

Activate Sync on each device in More > Settings by turning **Synchronize User Data** ON. Once turned on, Recent and Favorite Airports, Routes, Weather Imagery, User Waypoints, Aircraft, ScratchPads (iPads only), Flight Plans), Navlogs, Briefings, and Weight & Balance profiles are synchronized to all devices and ForeFlight Web.

If you change the order of items in a Favorites or Recents list on one device, the order of the items in the list will be synchronized to all other devices.

For example, suppose you have an iPad and an iPhone signed-in to your account, and two User Waypoints: WPT1 and WPT2 on your devices:

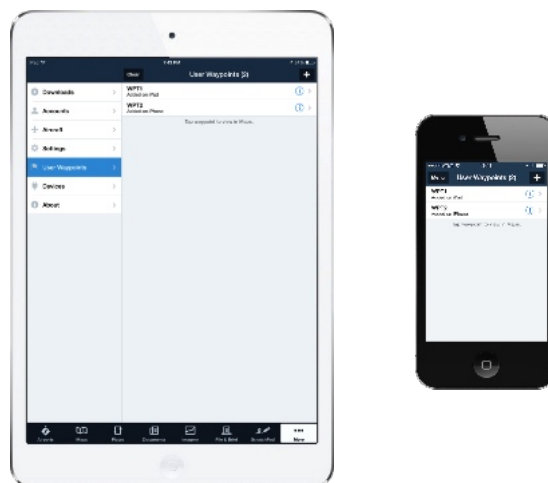

When you add a new User Waypoint WPT3 on the iPad, Sync will add WPT3 to the iPhone via the cloud:

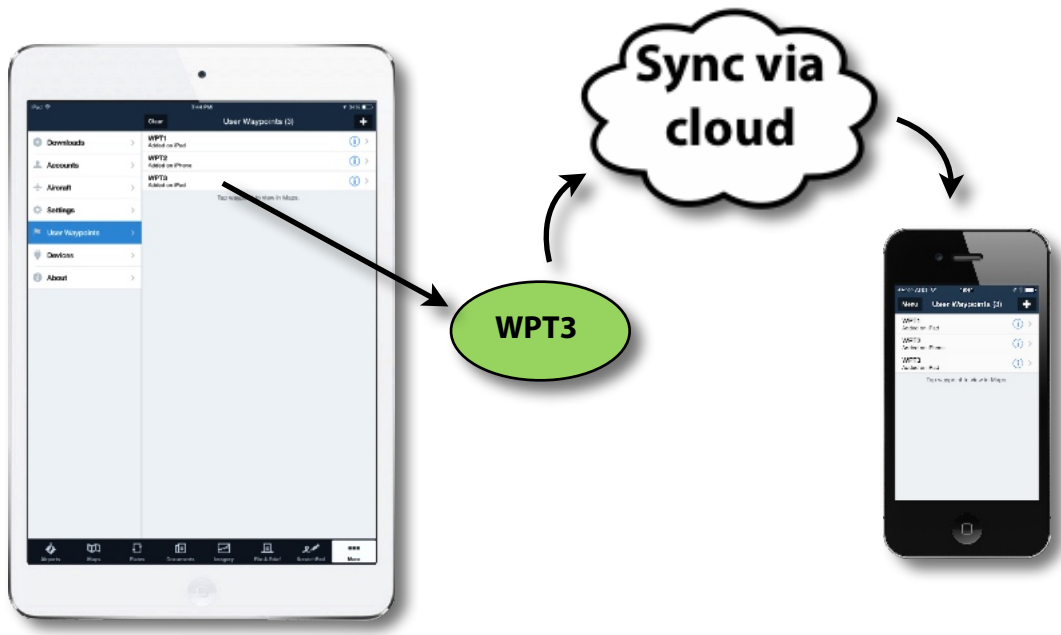

If you make changes on one device while it is not connected to the Internet, the next time that device goes online Sync will send those same changes to the other device(s) via the cloud.

IMPORTANT: If you delete a sync'd data from one device, Sync will also delete it from ALL other devices on which Synchronize User Data is ON. For example, if you delete WPT1 from the iPhone, Sync will delete the waypoint from the iPad via the cloud:



If Synchronize User Data is OFF on one device, as soon as you turn it ON, the item that was deleted from the first device will then be deleted from the other device.

NOTE: If you sign-out of the ForeFlight account on a device, ALL sync'd data is also removed from that device. Then when you sign back in to your account, all sync'd data is restored to that device.

NOTE: If a User Waypoint with the same name is manually created on two devices while one or more of the device(s) is offline, or while Synchronize User Data is OFF on one or more of the device(s), then when the devices are online or Synchronize User Data is turned ON, two User Waypoints will be shown with the same name on each device. Resolve this by changing the name of one of the same-named User Waypoints, or by deleting one of the same-named User Waypoints.

Cockpit Sharing

About the Design

Cockpit Sharing allows you to share a route with another device running ForeFlight Mobile, provided both devices are on the same Wi-Fi network: either an Internet-connected Wi-Fi-hotspot on the ground or a Wi-Fi-equipped ADS-B receiver like the Sentry family of portable ADS-B receivers.

Using Cockpit Sharing

Activate Cockpit Sharing on each device by tapping on **More > Settings** and turning "Cockpit Sharing" **ON**.

Send from an iPad: Tap the **Send To** button  on the Flight Plan Editor to see a list of all possible destinations. Tap the desired destination to send the route.

Send from an iPhone: Open the FPL drawer and tap the **Send To** button  to see a list of all possible destinations. Tap the desired destination to send the route.

On the receiving device, tap **View Route** on the popup to load the route, or tap **Cancel** to ignore the route sharing request.

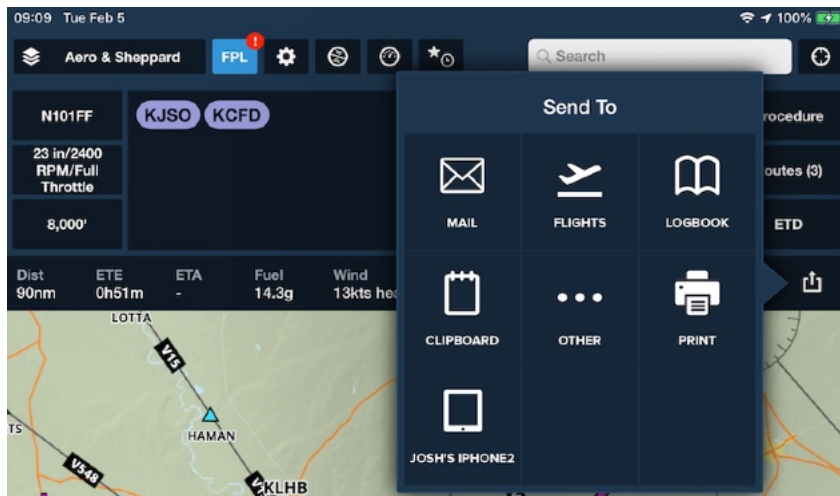

Plates

About the Design

Instrument pilots use their procedures differently in the air than when on the ground. Often, you'll view an arrival, approach, and then taxiway diagram - all without needing to return to a chart or A/FD in between. The *Plates* view is designed to account for the way you use procedures *while* you're flying.

The *Plates* view provides access to approach plates; taxiway diagrams, and arrival and departure procedures. This view enables you to organize the plates in the way that makes the most sense to you and streamlines your access to each procedure.



About Plate Binders

Binders provide a method for organizing plates into logical groups for easy access while in flight. A plate binder can contain any combination of:

- ❖ **Airport Diagrams**
- ❖ **Hot Spots**
- ❖ **Take-Off Minimums**
- ❖ **Departure Procedures**
- ❖ **Arrival Procedures**
- ❖ **Instrument Approach Procedures**

Creating a Binder

To create a new binder, tap the *Binder Selector* in the top toolbar. Use the + button to add a new binder and provide a name when prompted.

The binder is created and the *Plates* view automatically displays your new (empty) binder.

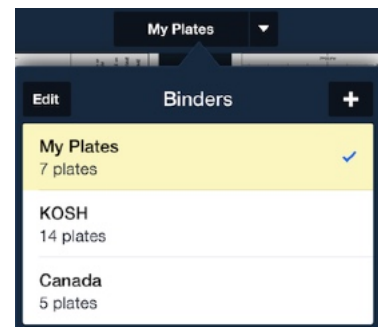

Managing Plates

There are two methods of adding plates to a binder.

The *Plate Search* box in the top toolbar allows you to search for a plate by airport, or by a specific procedure.

Example Searches:

- ❖ **KJFK** - Lists all procedures associated with the JFK airport
- ❖ **RHV GPS** - Lists the RNAV (GPS) approaches to the RHV airport
- ❖ **MDW ILS 13**- Displays the ILS Rwy 13C approach to MDW airport in the procedure viewer.

Open the plate, then tap the "Add to Binder" button in the top menu.



Or, tap the “+ ADD PLATE” thumbnail to display an intelligent list of airports gathered from airports you’ve used in other parts of ForeFlight Mobile. Tap an airport to see the available plates, or enter the airport you want to add. Then tap the procedure name or  icon to add it to the current plate binder.

To reorder or delete plates in a binder, tap the **Edit** button on the left side of the top toolbar.

Then hold and drag the plate to the new location. Note that you can add the same plate to the same binder more than once. For example, you might create a binder that contains plates for three local airports. You could elect to include each airport’s taxiway diagram both before each airport’s departure procedures *and* after each airport’s approach plates, making it easier to find the diagram in context during both arrival and departure operations.

To remove a plate from the binder tap the **X** icon in the upper left of the plate thumbnail.

When done editing, tap “Done”.

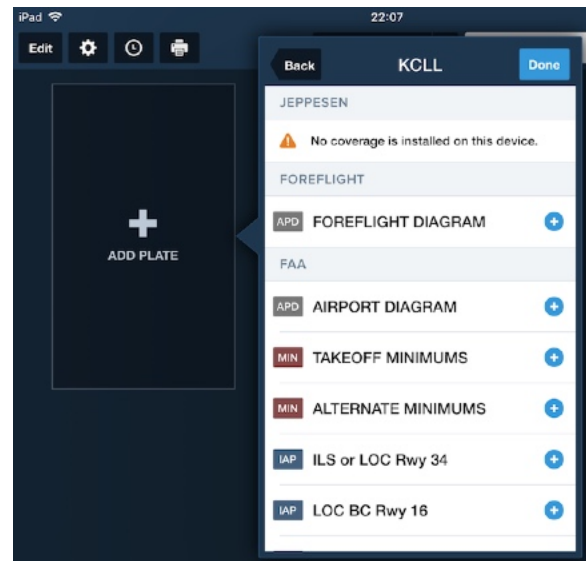
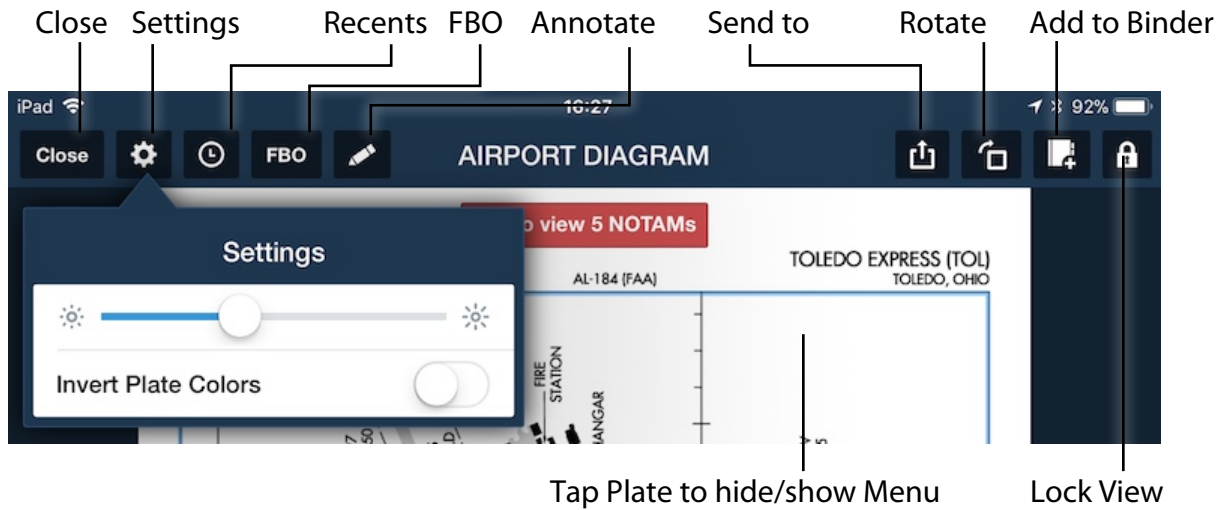

Plate Controls

Single-tap on the plate to hide/show the plate controls across the top of the plate and the Instrument view across the bottom of the plate.

The plate control buttons, including Invert Plate Colors under "Settings", are shown below:



NOTAM Advisor for Approach Plates and Airport Diagrams

When you display an Approach Plate or Airport Diagram on the Plates page, ForeFlight cross checks downloaded NOTAMs and displays a warning banner at the top of the plate showing a count of relevant NOTAMs related to that plate or diagram.

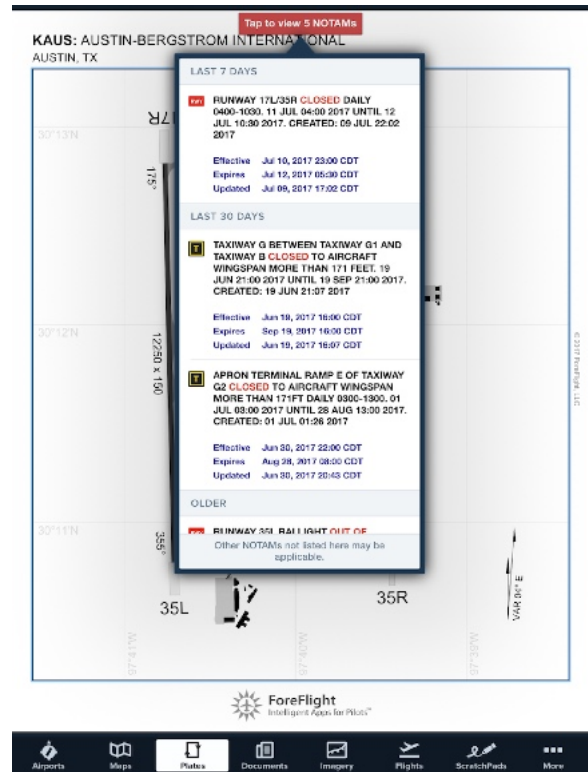
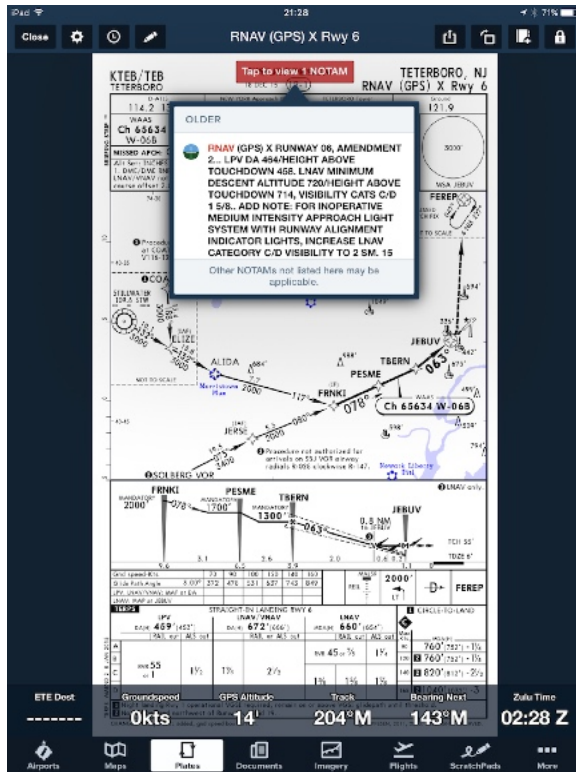

Tap the red banner to view the NOTAMs that are associated with the airport diagram or instrument procedure. Tap again anywhere off of the popup to close it.

FBOs on Airport Diagrams

When viewing an Airport Diagram (either FAA or ForeFlight) tap the “FBO” button at the top of the Plates menu to show/hide the location of FBOs that are known to sell fuel at that airport. FBOs can also be shown when the Airport Diagram is displayed on the Map (Pro Plus, Performance Plus, Business Pro, or Business Performance subscription required).

Show/hide FBO locations

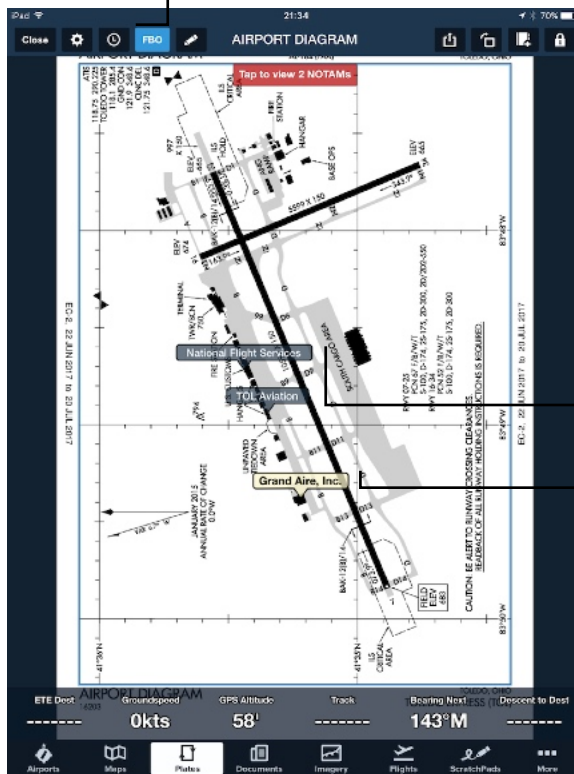

FBO locations

Featured FBO location

Featured FBOs are shown with a yellow flag; other FBOs are shown with a grey flag.

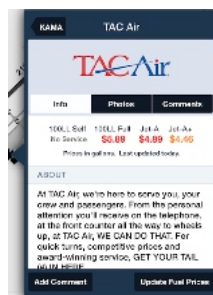

Tap an FBO's flag to open the FBO popup with [details about the FBO](#) including fuel prices.

Printing Plates From a Binder

Tap the **Print** button in the top toolbar of the *Plates* view. The *Printer Options* dialog box is displayed. From here, select a printer and a number of copies. Tap the **Print** button to send the selected number of copies of *ALL* plates in the binder to your printer.



To print only *one* procedure, tap the plate's thumbnail to display it in the procedure viewer, then tap the **Send To** button and choose "Printer."

Printing requires an AirPrint capable printer. For more information about this requirement, see:

support.apple.com/kb/ht4356

Ensuring Your Plates Don't Expire

When you view a plate or add it to your binder, ForeFlight uses either a copy of the plate stored locally on your iPad (by virtue of the fact that you've already downloaded it), or uses your iPad's Internet connection to fetch the plate and store it locally on your iPad. In either case, the plates are viewable *until they expire* - whether you have an Internet connection at the time you view them or not.

When these plates expire, *they are only automatically replaced if you have used the Downloads view to download new terminal procedures for the states/regions associated with the plates in your binder*. Otherwise, the plates are only replaced when you open the binder *and* have an Internet connection. In-flight is not the time to discover this.

Be sure to check your selections in **More > Downloads** to ensure ForeFlight is set to download terminal procedures for all states covered in your binders and that all requested data has been downloaded. This ensures all plates in your binder will be current and available to you at any time - on the ground or in the air.

Plates and Taxi Diagrams on a Map

About the Design

This feature allows you to overlay geo-referenced plates or airport diagrams on the Maps view. Viewing plates and taxi diagrams on a Map requires an active ForeFlight Pro Plus, Performance Plus, Business Pro, or Business Performance subscription. To upgrade, visit www.foreflight.com/buy.

In North-up mode, the plate or airport diagram is displayed on the chart right-side-up; in Track-up mode, the plate rotates along with the chart so that your ground track is towards the top of the map.

Using in-flight ADS-B or XM weather, radar and other weather information can also be displayed on the Map with the plate. Radar or Satellite can be displayed while on the ground and connected to the Internet.

You can add the waypoints on the approach by rubber-banding your route: for each waypoint, touch-hold the route line, then drag it to the waypoint and release to display the waypoint popup. Choose the waypoint name to add that point.

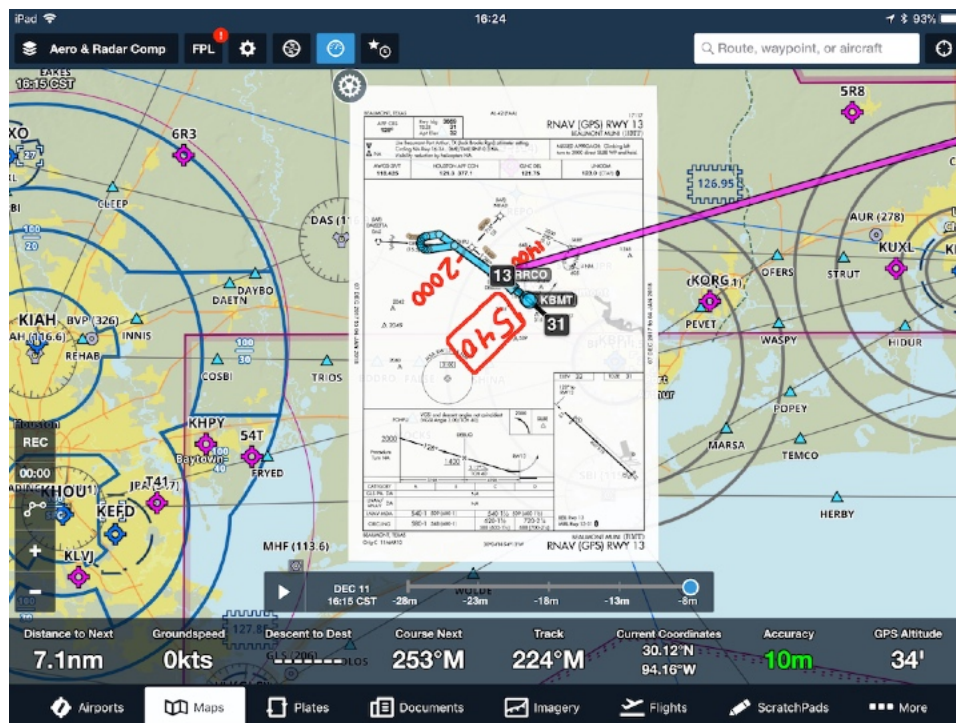

Displaying a Plate on a Map

You can display a US Approach plate or Airport diagram on the map in five ways:

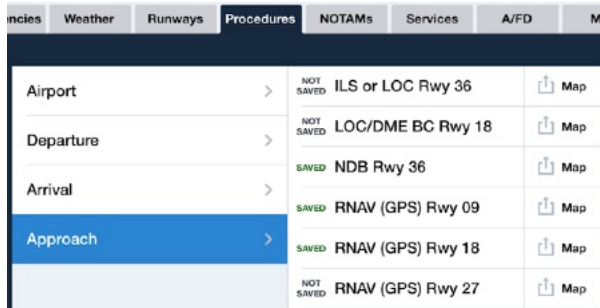

1. From the **Airports** page, tap the **Map** button next to the desired approach in the Procedures list.

2. On the **Maps** page, touch-hold the airport, tap the grey **More** button, then the **Details** button in the popup (or tap the airport on the Aeronautical layer) then scroll to Procedures and tap Approach. Finally tap the **Map** button next to the desired approach.

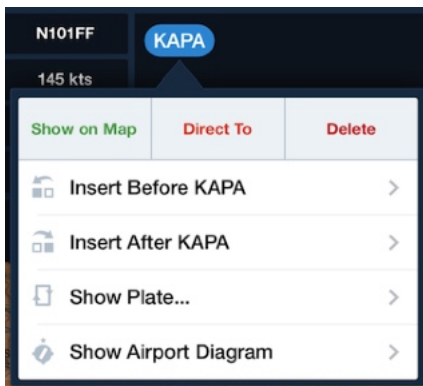

3. From the **Route Editor**, tap the colored oval and choose "Show Plate..." (or "Show Airport Diagram").

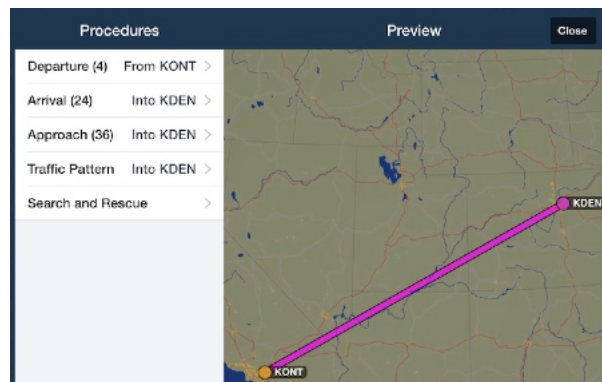

4. From the **Flight Plan Editor**, tap the Procedure Preview button then choose the Approach.

5. From the **Plates** page tap the **Send To** button and choose **Map**:

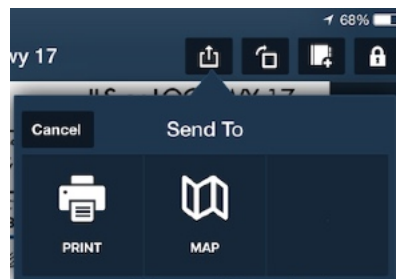

Changing or Hiding the Plate on a Map

Once you have displayed an approach plate or airport diagram on the map, you can change or hide it by tapping the gear button  or by tapping on the plate itself to display the popup. There you will see the selected plate (highlighted in yellow with the checkmark) and you can scroll through the list of available plates to select a different plate. Tap a different plate to display it on the Map.

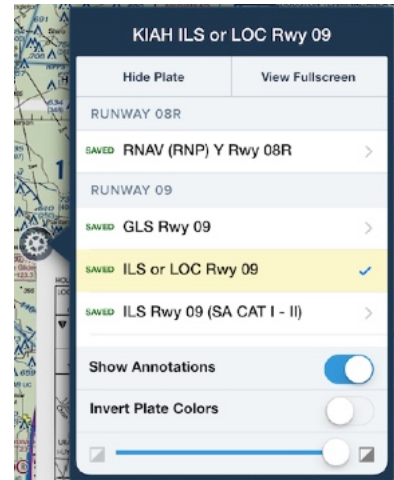

You can also tap **Hide Plate** to remove the plate from the Map, or tap **View Fullscreen** to open the plate on the Plates page. Turn **Show Annotations** OFF to hide any annotations you made to the plate. Turn **Invert Plate Colors** ON for easier viewing in low-light situations, and you can adjust the transparency of the Plate on the chart using the slider.

Adjusting Plate Transparency

Once you have displayed an approach plate or airport diagram on the map, tap the Map Settings “gear” button to adjust the transparency of the plate from fully opaque (completely covers the underlying map) to more transparent so the underlying map shows through. You can also adjust the transparency of the Radar layer (if selected).

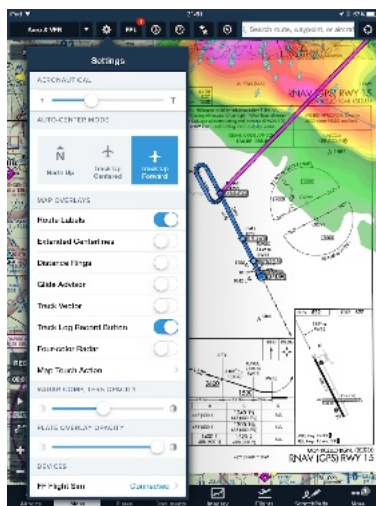

Fully-opaque (slider to right)

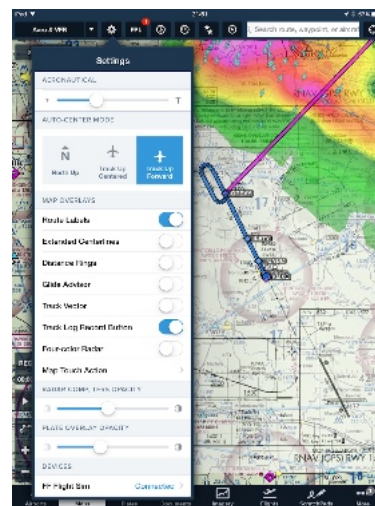

Mostly Transparent (slider to left)

Track Logs

About the Design

Track Logging records details about your flight including track and altitude using any compatible GPS, such as an external device like a Sentry, or your iOS device's internal GPS. Track Logs are synchronized across your devices using Sync. Track Logs can be sent via email, are available for viewing and downloading at the ForeFlight website, and can be exported to apps like CloudAhoy and Google Earth, as well as to KML and GPX files. Track Logs can also be imported to ForeFlight Logbook as new entries if it is part of your subscription.

Track Logging is very efficient: the log files require less than 300KB per hour recorded.

Enabling Track Logging

Track Logs can be enabled for either manual or automatic recording. tap **More** > **Settings**, then scroll to the **Track Log** section. To enable manual recording, switch Enable Start/Stop Control to *ON*. When this setting is *ON*, the REC button and a timer indicating the length of the current recording are shown in the lower-left corner of the Maps view above the zoom buttons. To enable automatic recording, switch Enable Auto Start/Stop to *ON*.



Start/Stop Logging

When automatic recording is enabled, a new Track Log is started as soon as the app detects a takeoff, which corresponds with a certain speed threshold. A new Track Log can also be started at any speed by tapping the REC button. In either case the REC button turns blue and the timer starts counting up, indicating the length of log file. The recording continues until the REC button is tapped again, or until the app detects a landing, which is also associated with a speed threshold.

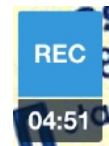

With automatic recording, your location data prior to takeoff and after landing are added to the front and back of the Track Log, respectively, to account for taxiing. This extra recording time at the front of a Track Log is reflected in the timer upon takeoff.

When using the built-in GPS or a Bluetooth GPS, the recording will continue even if you switch to another app. **NOTE:** background recording is not currently available when using a Sentry or other Wi-Fi connected device for GPS. If you put ForeFlight

Mobile in the background or quit it completely while recording a track log, the recording will stop or be incomplete.

If you put ForeFlight Mobile into the background while logging, verify that the REC button is still blue (Recording) when you re-open ForeFlight Mobile.

Flight Time Instrument

The “Flight Time” instrument can be used in conjunction with track logging to display actual flight time. When Track Log recording is enabled, either manually or automatically, the Flight Time instrument will begin counting up from zero after you take off and continue counting until you land or the Track Log recording is stopped.



Track Log Listing

Tap **More > Track Logs** to see a list of the available Track Logs. Each log entry shows the date it was recorded, the length of the recording in hours and tenths of an hour, the GPS source, and the aircraft’s tail number, if it has been entered or automatically captured from ADS-B Out. If the Track Log was used to create a Logbook entry, a small “book” icon is shown next to the name of the device that recorded the Track Log. You can search by departure or destination, aircraft, GPS source, and device name:

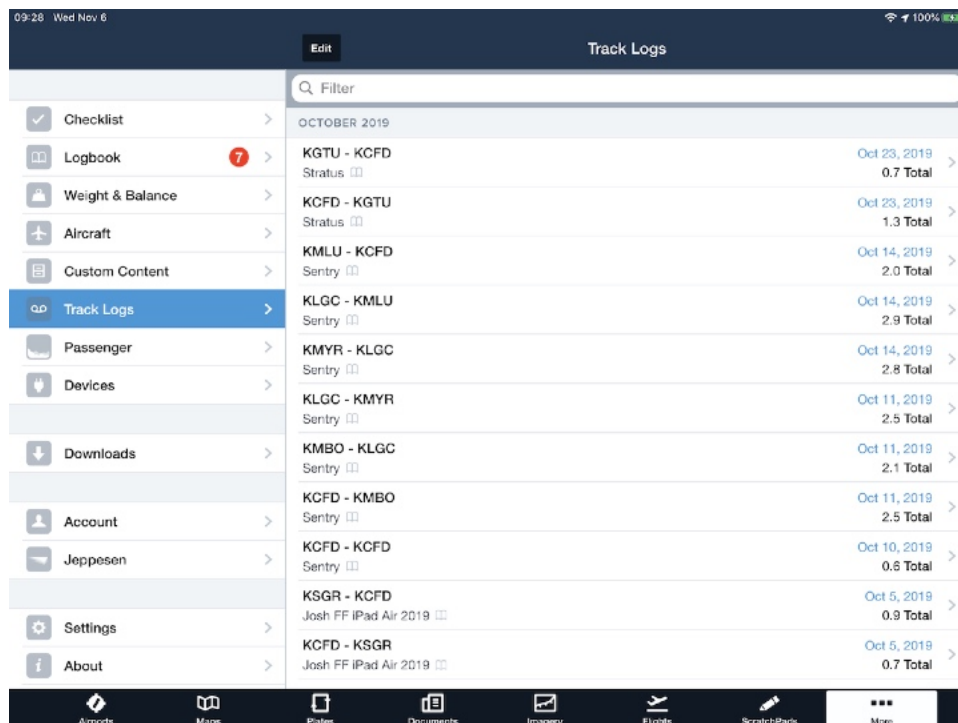

You can delete a Track Log using swipe-delete: swipe your finger from right to left across the listing, then tap the red "Delete" button. **IMPORTANT:** Once you swipe-delete a Track Log, it is gone forever, and will no longer be available via Sync or on the ForeFlight website.

All changes you make to a Track Log will be sync'd to the other devices on your account.

Graphical Track Log view

The Graphical Track Log view is a new, full-screen interactive view of a saved Track Log. Tap a Track Log to open the Graphical Track Log view. The top of the Graphical view shows a map of the track log, that can be panned & zoomed. The bottom shows a timeline-based graph with selectable information including Altitude, Speed, and if your Track Log was recorded with an AHRS-capable device like a Sentry: Pitch, and Bank. 2 combinations are selectable at a time.





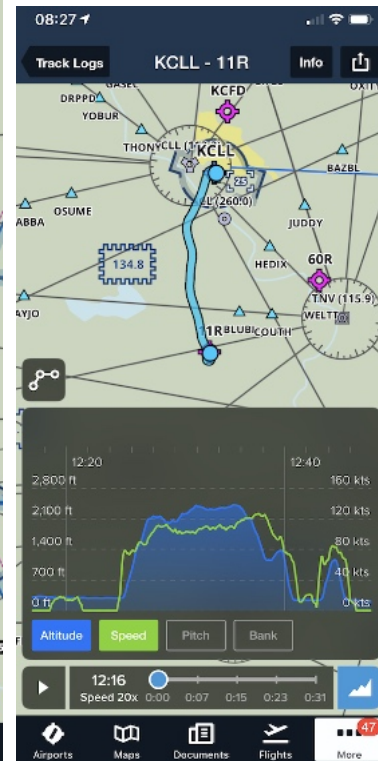



iPad view



iPhone view

Control Buttons

	Tap to hide/show the graph.
	Tap to start/pause the replay of the flight (at 20 times actual speed).
	Tap "Fit to route" button to display the entire route.
	Tap to return to the Track Log list.
	Tap for text information about the Track Log.
	Tap the "Send to" button to share or export the Track Log, or create a Logbook entry.
	Tap to open the 3D review of the Track Log (requires a Performance plan)

When viewing a Track Log, you can use two fingers to pinch-zoom (left-right) inside the Graph area to zoom-in on a particular area of the Track Log, and use one finger to scrub left or right in the Graph area to focus on different areas of the track log.

The area of track log in-view on the Graph area is shown on the map with a thicker blue line, and the areas outside of that area are shown with a thinner orange line.

Use 1 finger to scrub along the timeline to change the location of the aircraft and the corresponding vertical line in the Graph view.

Tap the "Info" button to open a pop-up where you can view and edit additional information about the track log, including a



more descriptive name, the Pilot's Name, the Tail Number, and Notes. If ForeFlight detects ADS-B Out capability for your aircraft it will automatically capture the tail number and add it to the Track Log.

If you have a Performance Plan, tap the "3D" button to open a 3D Review of the track log. Switch between first person and third person views using the buttons in the lower-left of the screen, and use one finger to pan the view, and use two fingers to pinch-zoom.

Tap the AHRS button to switch between a "straight-and-level" view and a view showing the AHRS data recorded in the track log by a compatible device such as a Sentry.

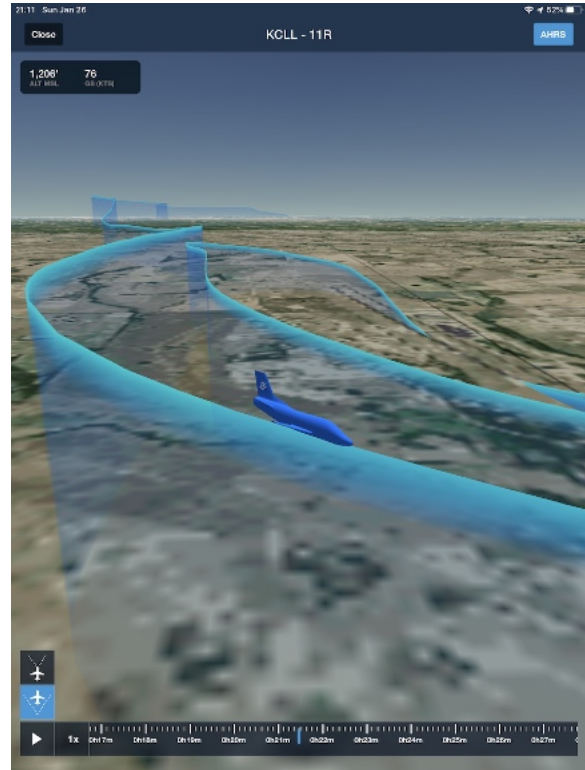

If a Logbook entry was created from the track log, you can tap the row in the "Logbook Entries" section to display a popup with details of the Logbook entry.

LOGBOOK ENTRIES	
11R - KCLL N16895 (C172) 📍	September 17, 2018 0.4 Total >
NOTES	

Synchronizing Track Logs to other Devices

Newly-recorded Track Logs are automatically uploaded to the ForeFlight Cloud when your device connects to the internet after a flight. You can then view and edit the Track Log's information on other devices on your account, as well as import it to ForeFlight Logbook, share it on social media, view it on ForeFlight's site, and email a link to the Track Log.

Emailing the full Track Log or opening it in another app on your device require that you download the Track Log's file; a popup when selecting one of these options prompts you to download the Track Log.

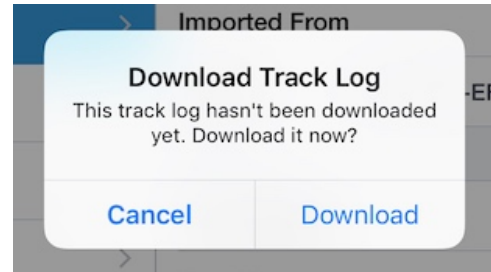

Viewing a Track Log on ForeFlight on the web

When viewing a Track Log's details, tap the Send To button in the upper-right corner and tap the "foreflight.com" button to open Safari and view a summary of the flight on the ForeFlight website.

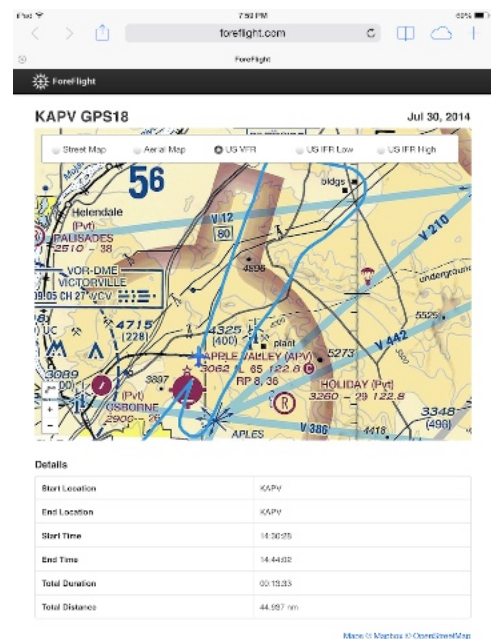

Tap the Chart selection button  in the upper-left corner of the map to choose between Street Map, Aerial (Satellite) Map, US VFR charts, and US IFR Low and High charts.

Sharing Track Logs

Track Log details can be shared via email, Twitter, and Facebook (provided you have set up your accounts in Apple Settings). Tap the Track Log entry, then tap the Send to button in the upper-right of the screen and choose how you would like to share the Track Log. You can also send the Track Log to your logbook, which creates a new entry and auto-populates it with the Track Log's details. **NOTE:** iOS 10 and earlier

show Facebook and Twitter as separate items in the Send To menu; iOS 11 and later show an “Other” option which includes Facebook, Twitter, and others.

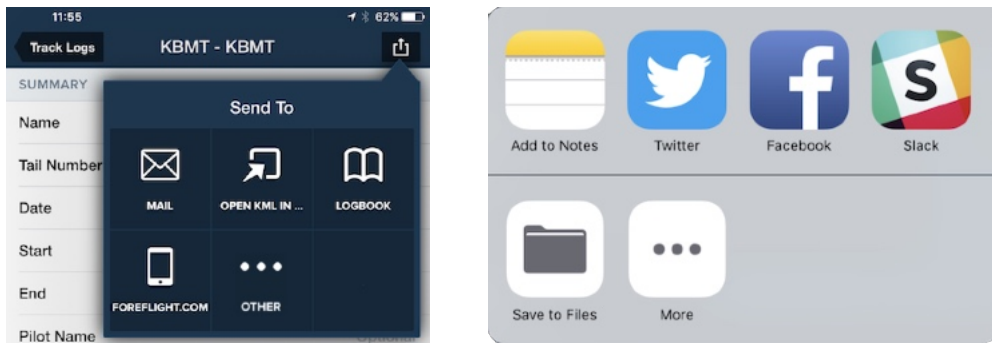

When sharing the full Track Log via email, a KML file of the Track Log is attached to the email, along with the a link to view basic information about the Track Log on the ForeFlight website.

Exporting Track Logs to other Apps

Tap the Track Log entry, then tap the Send To button in the upper-right corner and tap “Open KML In...” to export the data to CloudAhoj, Google Earth, or other compatible apps.

Google Earth is an useful resource for viewing the 3-D view of the Track Log on your device.



Importing G1000 Track Logs

ForeFlight Mobile can import track logs recorded by a suitably-configured Garmin G1000, to simplify how you organize and access your recorded flights.

A suitably configured G1000 can save recorded track logs as CSV files on an SD card inserted into the top slot of the MFD. If you've already extracted these files onto your home computer or laptop, you can transfer them to ForeFlight Mobile via AirDrop, iTunes file transfer, or by sharing through email or other apps that you can access on your iOS device.



If your iOS device has iOS/iPadOS 13 or later you can also transfer track logs from an SD card using an adapter that matches your device's data and charging port (Lightning or USB-C).

Insert the SD card from the top slot of the G1000 MFD into the SD card reader, then plug it into your iOS device. Then tap the Import button in the upper-right of the Track Logs page, and tap "From G1000 (CSV File)"

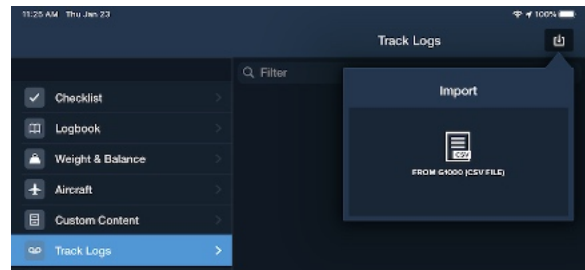

When the iOS Files view opens, tap Browse, then choose the USB icon to open the SD card, which will likely be named GARMIN. Tap the "data_log" folder, then tap on the track log you want to import.

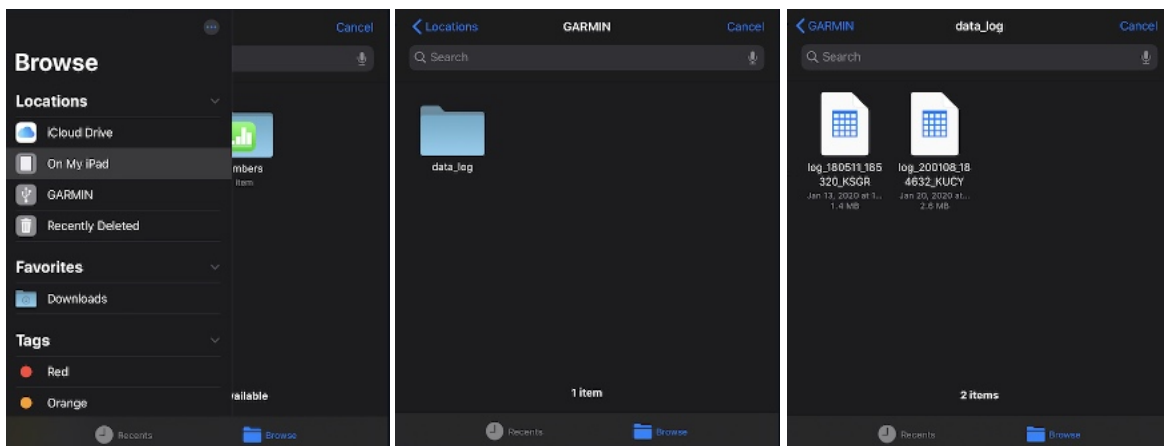

NOTE: If ForeFlight Mobile cannot successfully import a G1000 track log for any reason it will generate a text file explaining the error, along with the original track log in a zip file. Tap Export Now to share the zip file via AirDrop or other apps.

After tapping the track log to import, if you haven't imported flights from that aircraft before, ForeFlight will prompt you to enter the tail number to associate with the track log. Future imports of G1000 track logs from that aircraft will not prompt for the tail number.

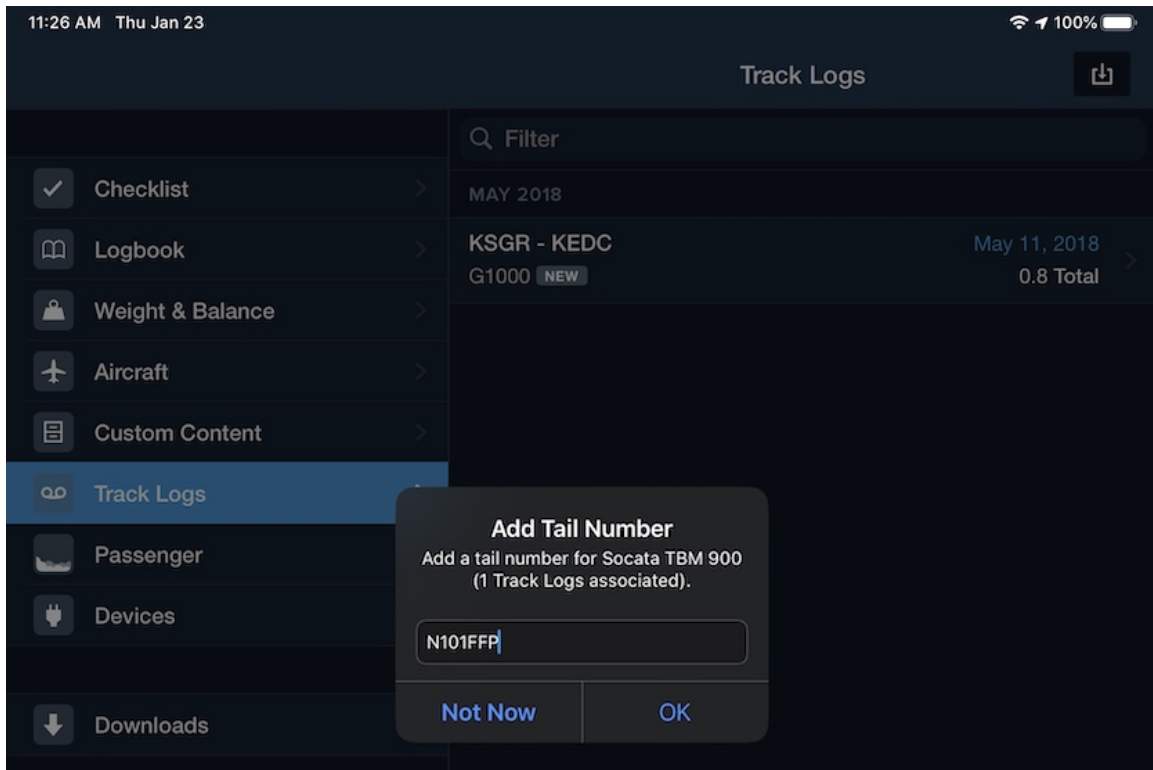

After importing the track log, a "NEW" flag shows until you change away from the Track Logs page.

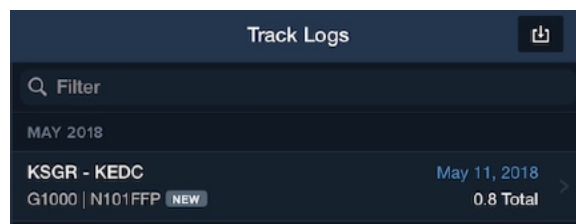

See all G1000 track logs that have been imported by entering G1000 in the Track Log "Filter".

Viewing Track Logs in ForeFlight on the web

Sign in to your ForeFlight account by clicking the Login button at www.foreflight.com, then click on the “Track Log” menu item to view all of the Track Logs on your account. Click the track log you want to view from the list on the left.

The screenshot displays the ForeFlight web interface. On the left is a dark sidebar with navigation options: Maps, File & Brief, Aircraft, Logbook, Track Logs (selected), Users, and Acme A. The main content area shows a list of track logs with columns for Start Date and End Date. The selected track log is "KDWH → KDWH" from August 8, 2016, with a total duration of 01h 08m and a total distance of 112.51nm. To the right of the list is a detailed view for this track log, titled "KDWH → KDWH". It features a map showing the flight path around the Dallas-Fort Worth area. A "Download" menu is open, showing options for KML (Filtered), KML (Full), GPX, and CSV. Below the map are sections for "ROUTE" (60R KDWH 160kts 12gph N123TS 5000ft), "SUMMARY" (Start Time: 00:20:11 UTC, Average Speed: 112.36 kts, End Time: 01:28:50 UTC, Recorded On: FF iPad, Total Duration: 01:08:38, Imported From: IOS, Total Distance: 112.51 nm, GPS Source: IOS), and "ACCURACY" (Maximum Vertical Error: 19 m, Maximum Horizontal Error: 10 m).

Click on the “Download” button in the upper-right then choose one of the KML options, GPX, or CSV to download the Track Log file in that format.

Breadcrumbs

About the design

Breadcrumbs are an extension of the [Track Log](#) capability, but operate independently to display thin green line indicating your aircraft's path since takeoff. When switched ON in Maps > Settings, the Breadcrumbs trail automatically activates on takeoff and ends when you land. The Breadcrumbs can be set in More > Settings to persist for 15 or 30 minutes after landing so you can review the path after your flight.

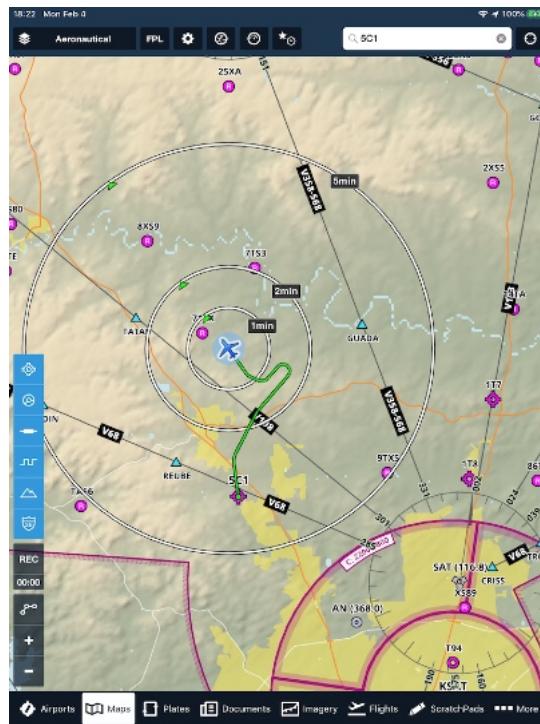

Tap a Breadcrumb trail anytime to view flight metrics, to save the Breadcrumb trail as a new Track Log, or to reset it without saving.

Saving a Breadcrumb trail as a new track does not affect an ongoing Track Log recording. This means you can use Breadcrumbs to track individual maneuvers by saving a Track Log of each one, then resetting the Breadcrumbs after saving. At the conclusion of the flight you will have the entire flight Track Log as well as any individual Track Logs you saved from Breadcrumbs.

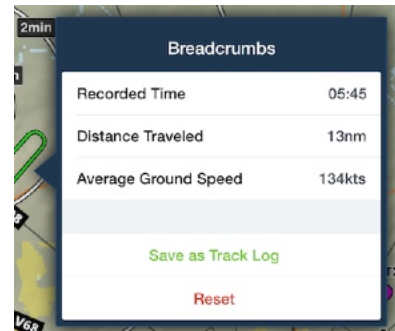

Documents

About the Design

The Documents view lets you download, import, view, and annotate PDF, image, Office (Word, Excel) and text documents. When Sync is activated for your account, documents, annotations, bookmarks, binders, and a document's position in a binder are synced across all of your devices and are backed-up to the ForeFlight Cloud. You can organize your documents into Binders, bookmark areas of interest inside of a document, and quickly switch between reading a document and other app views. And beginning with ForeFlight Mobile version 11.3, Documents are available on the iPhone, replacing the Imagery tab in the center of the navigation bar (Imagery on the iPhone moves to the More tab), and Document titles are included in ForeFlight's unified App Search, so you can easily find and view documents from other app views.

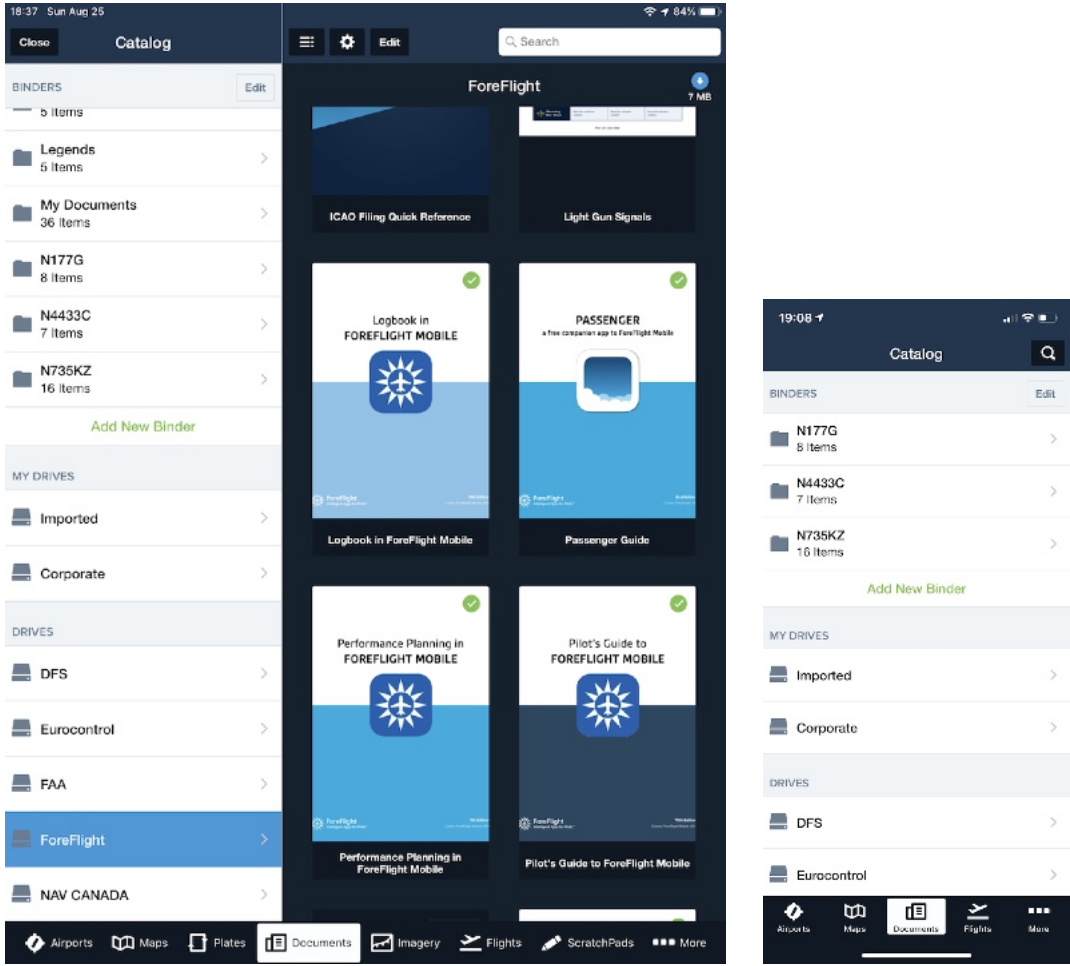

Drives and Binders

Documents in 11.3 introduces the concept of Drives, which serve a dual purpose as a place where you can both select which documents to download from published Drives such as ForeFlight, FAA, NAV CANADA, Eurocontrol, etc..., and also where you can view and open those documents after you download them.

In the iPad the Catalog (Binder/Drive) view is automatically shown the first time you open the Documents view; tap the “Close” button to hide it, and the “Catalog” button to re-open it.

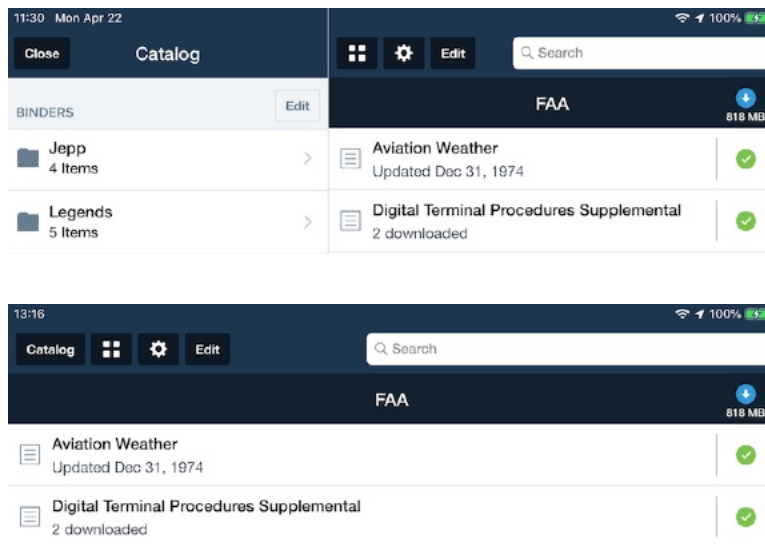

In the iPhone the Catalog view is always shown, and you can navigate into a Drive or Binder, then back to the Catalog view using the “Back” button in the upper-left.

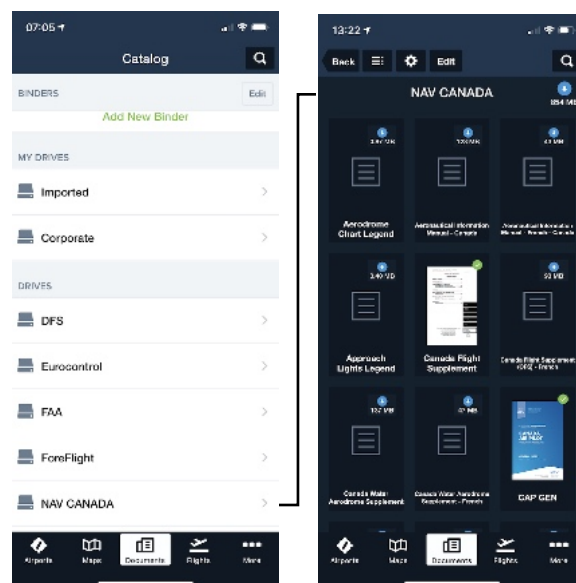

Tap the “List/Binder” button  at the top of the Documents view to switch between a condensed list view that shows each document’s name (plus any relevant date ranges), and a tiled view showing a thumbnail of each document.

Drives also support nested folders, allowing you to download documents individually or to select the entire folder for download by tapping the blue download button to the right of the folder name or the corner of its thumbnail.

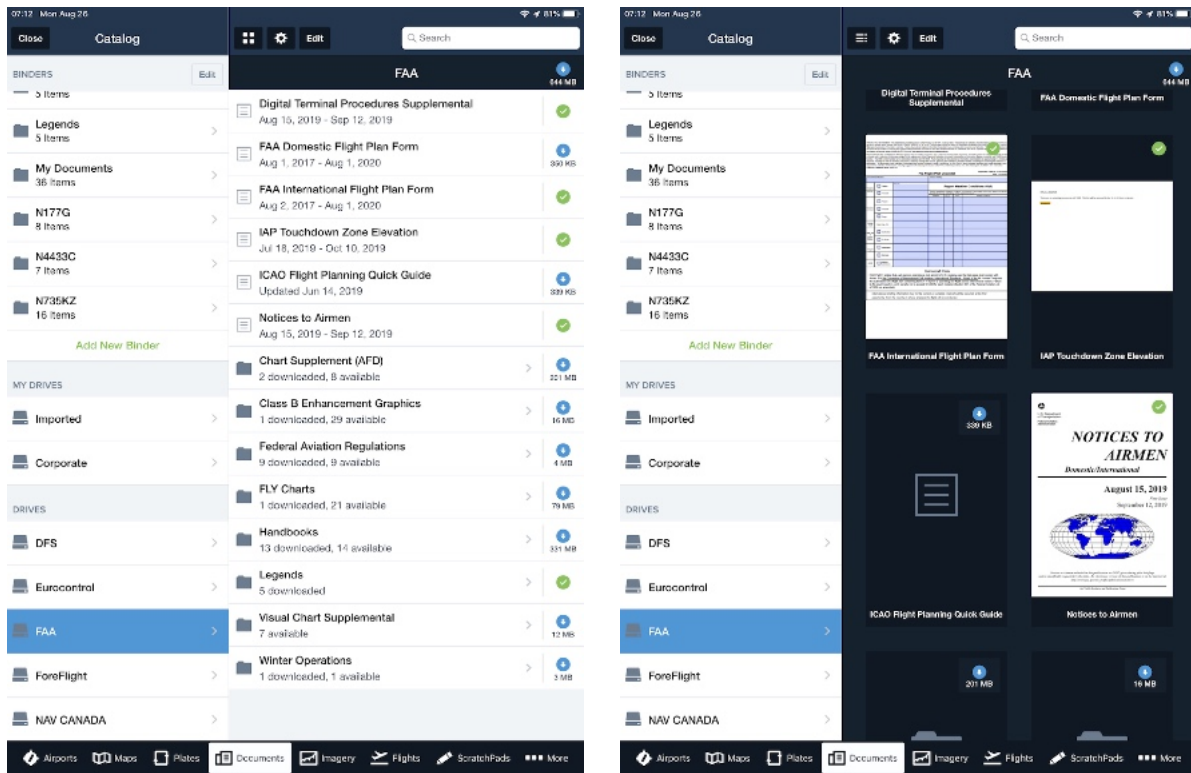

ForeFlight supports a wide range of file types for importing and viewing in Documents: pdf, tiff, tif, jpg, jpeg, gif, png, bmp, bmpf, txt, doc, docx, xlsx, xls, pptx, ppt, csv, pages, key, and numbers.

Cloud Document Drives (eg: from a connected Dropbox, Box, or Amazon S3 cloud storage account) continue to support nested subfolders. [Cloud Document Drives](#) are available with Pro Plus plans and above.



Downloading and Opening a Document

Tapping a document title or thumbnail will cause it to be downloaded (if it's not already on your device) and then open. The  icon next to a document title or thumbnail indicates that the document has been downloaded and is already in the current Drive or Binder.

If you download an individual document in a Drive on one device, it will not automatically show on the other device. However if you add that document to a Binder it will show up as ready to be download on the other device. Tap the document on the 2nd device to download it.

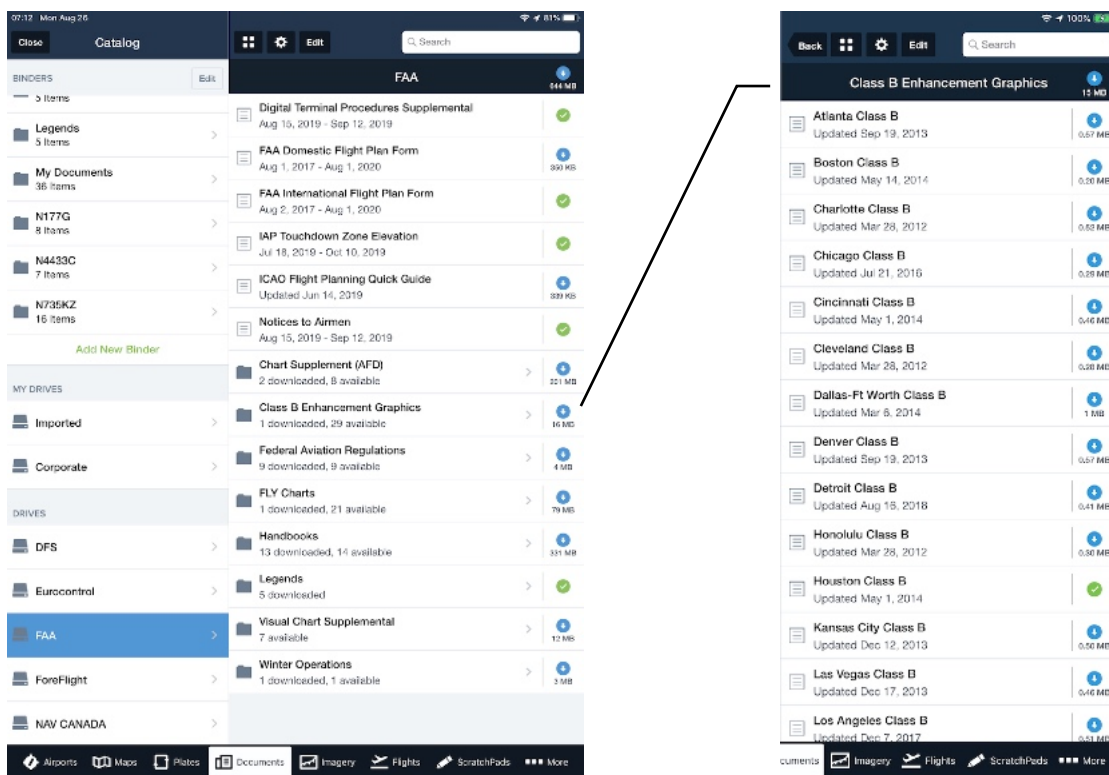
Tap on a folder to view its contents, and tap on the blue "Download All"  button to the right of a folder name (or in the upper-right of the thumbnail) to download all documents in the folder.



To delete all documents from a drive (which shows the green check  indicating that Drive-level automatic downloads are active or all current documents are downloaded), tap "Edit" then tap the large X button: . Then tap "Done" when finished.

Automatic Document Updates

When you download an entire Drive or folder using the blue “Download All”  button, ForeFlight will automatically download updated versions of existing documents and new documents that are added to the drive or folder. If you only download individual documents from a Drive or folder, or if you first “Download All” but then remove a document, ForeFlight will keep the downloaded documents up to date when new versions become available, and new documents added to the Drive or folder will show in the list but will not be automatically downloaded.

Creating and Managing Binders

Because of the introduction of Drives you no longer have to create a Binder to store your downloaded documents. However you still can add Binders to easily group documents from different Drives.

To create a new Binder, tap the green “Add New Binder” text at the bottom of the Binder list. Or when viewing a document, tap the “Binders” button, then tap the “+” and enter the new binder name.

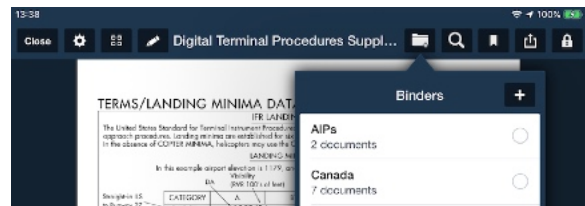

A Binder created on one device is automatically synced to your other devices, and if you change that Binder’s name **or delete it from one device**, that change is also automatically synced to your other devices. But because documents are stored in Drives, deleting a Binder does not delete the documents it contained.

Binders appear in the list in alphabetical order, and documents initially appear in a Binder in the order they were added. You can organize individual documents within a Binder by tapping the “Edit” button, then touch-dragging the thumbnail or the stacked-line “handle” to position the document.

Tap “Done” when you have finished moving documents.

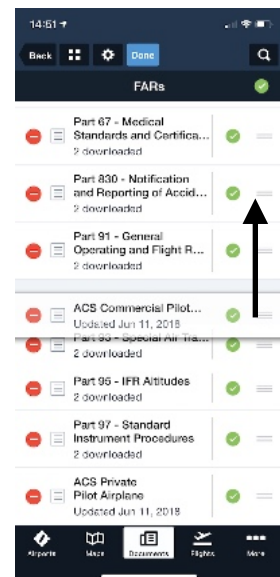
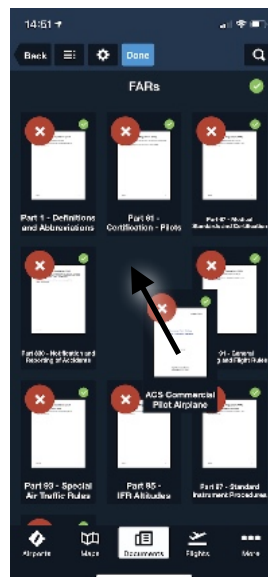

Deleting a Document

You can delete a document in several ways, depending on the view.

In List view swipe-delete (swipe your finger from right to left, then tap the red “Delete” button) or tap Edit, then tap the red circular button followed by the red “Delete” button.

In Thumbnail view, tap “Edit” then tap the red “X”.

If you delete a document from a Binder it will be immediately removed from the Binder on all devices. **However the document will still be on the iPad, accessible in the source Drive.**

However if you delete a document from a Drive a pop-up will appear, depending on whether or not the document is already stored in a Binder. Once you tap “Remove” the document will be removed from the Drive and any Binders.

If the document is in a Binder, you will see this pop-up:

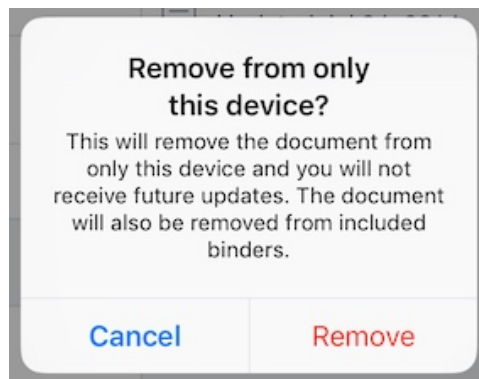

If the document IS NOT in a Binder, you will see this pop-up:

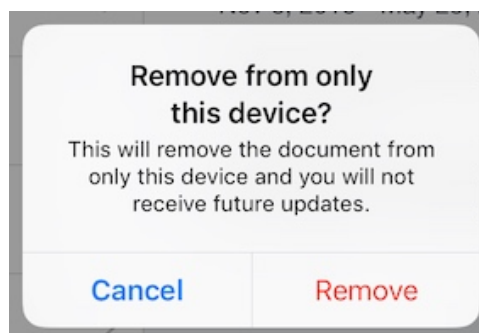

Cloud Document Syncing

If you have a ForeFlight Pro Plus, Performance Plus, Business Pro, or Business Performance subscription, you can link your ForeFlight account to a Cloud storage provider such as Dropbox, Amazon S3, or Box account (free or paid) at <https://plan.foreflight.com/account> and click on the Integrations tab, then click “Manage.”

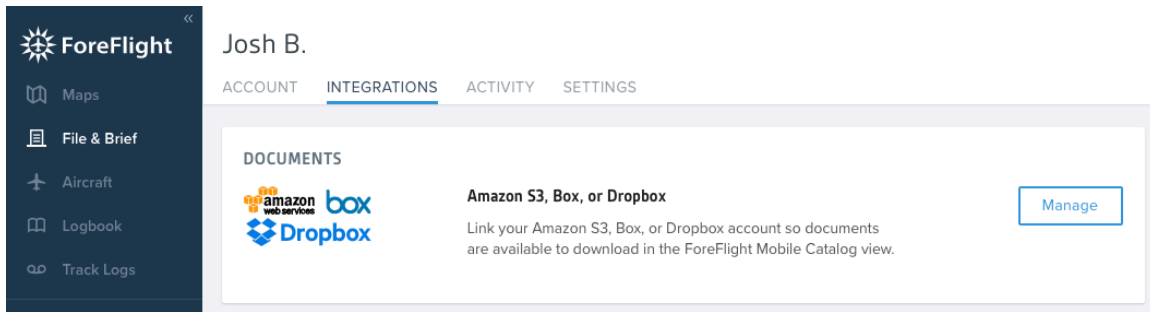

Click the “Connect” button (which shows if there is not yet a connected account) to link your document storage account to your ForeFlight account. If your ForeFlight account has already been linked, click the “Manage” button to manage the Catalog name (which is the name of the Drive shown in the app), manage default Syncing behavior, or to un-link the account.

Once you link your Cloud Drive account to your ForeFlight account, any compatible documents you place in the appropriate folder on your computer are automatically shown in the ForeFlight Documents tab under the corresponding Drive (which is named whatever you entered in the “Catalog Name” field). If **Document Syncing** is checked, when a new device signs-in it will be “subscribed” to the Cloud Drive and all of the Cloud Drive documents will be automatically downloaded to that device. If “Document Syncing” is not checked, when a new device signs-in it will see the list of available documents, but none will be downloaded automatically.

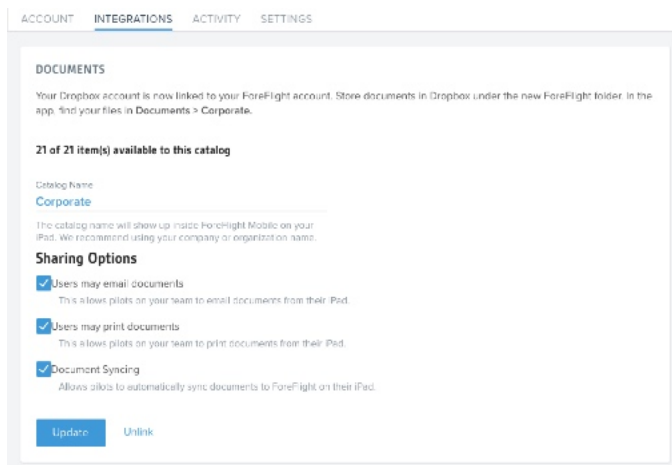

IMPORTANT: DO NOT USE any of the following as your Catalog name, or as a sub-folder name inside the main folder: “ForeFlight”, “FAA”, “NAV CANADA”, “Eurocontrol”, “Imported”, or “Jeppesen”.

Computer folder locations where documents should be saved:

NOTE: These folder locations are created automatically when you link your account to your ForeFlight account.



Dropbox: /Dropbox/Apps/ForeFlight

Box: /Box Sync/ForeFlight



Amazon S3: folder is selected at the time of account linkage

Any changes or updates you make to a document in the Cloud Drive folder on your computer will be automatically appear in the available document list in the Cloud Drive in ForeFlight Mobile, and by default any new documents you add to the Cloud Drive folder will download automatically in ForeFlight Mobile.

Automatic Downloads / Download All

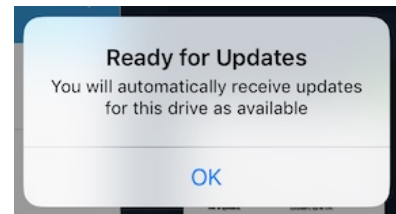
To download ALL listed documents into the Cloud Drive in the app, tap the blue “Download All”  button in the upper-right corner. The button will change to a green check  indicating that Cloud Drive-level automatic downloads are active, so new documents added to the Cloud Drive will show in the available document list and will be automatically downloaded.



NOTE: It is possible to have downloaded all documents in a Cloud Drive (so the green check  shows in the upper-right) but to not have the Cloud Drive-level automatic downloads active. This means any documents added to the Cloud Drive in the future would be shown in the list but would not be automatically downloaded. If that happened, the “Download All” would again turn blue after the document(s) were added . Tap the green check  to confirm the Cloud Drive-level automatic downloads are active.

On an individual device, swipe-delete a document or folder in the Cloud Drive to remove it from the device. **Removing a document or folder will disable the Cloud Drive-level automatic downloads for that device**, so new documents added to the Cloud Drive will show in the available document list (along with the blue “Download All”  button in the upper-right corner) but will not be automatically downloaded on that device.

Whenever new documents are added to your Cloud Drive folder, ForeFlight Mobile will briefly display a red dot with a number in it on the corner of the More tab, and on

the Downloads view. Once the document downloads automatically, the red dot will disappear.



To download individual documents into the Cloud Drive, tap on the Documents tab, then tap the Cloud Drive. Then tap on the thumbnail or title of the document that you wish to download.

After a document is removed from the Cloud Drive folder your computer, it will also be automatically deleted from any devices that have downloaded it the next time the devices connect to ForeFlight's servers via the Internet. The removed document will be deleted from both the Cloud Drive and from any other Binders where the document(s) had previously been saved.

Unlinked Cloud Drive: <Missing Drive>

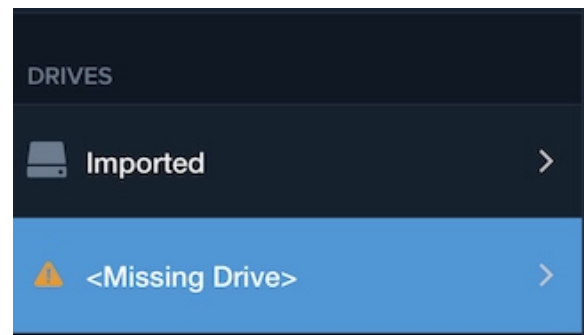
If the Cloud Drive account is un-linked from your ForeFlight account, all Cloud Drive documents are retained on the devices that had downloaded them in a Drive called **<Missing Drive>**. The documents will remain on the iPad until they are either deleted by the pilot, or the pilot signs-out of their ForeFlight account on the iPad. Signing-out removes all sync'd documents.



To delete all documents from a Cloud Drive on the device, first tap the blue "Download All"  button or the green check  in the upper right. Then tap "Edit", and finally tap the large red "X" button:

If a Cloud Drive account is un-linked but then re-linked with a different Catalog Name than before, a new Cloud Drive name will be created on all signed-in iPads.

Importing Documents from iTunes or other Apps

You can import documents using iTunes, or from other apps including but not limited to Safari, Mail, Dropbox, and Gmail. Imported documents are all saved in the “Imported” Drive.

❖ **Importing from iTunes** - Plug your iPad into your computer using the Apple USB cord and start iTunes on the computer. Inside iTunes, click on the name of your iPad under the Devices listing on the left. On the right pane, click the Apps tab at the top. Scroll to the File Sharing section at the bottom of the page and click on ForeFlight. On the right, you will see a table titled ForeFlight Documents. Drag and drop your files onto this table. While the files are copying over, you will see a brief Sync in Progress message on your iPad. After the copying has completed, launch ForeFlight Mobile and tap on the Documents tab. The imported Documents appear in the “Imported” Drive. After a file is imported, it will disappear from the iTunes listing.

❖ **Importing from Mail (email)** - tap the attachment to open or view it, then tap the “Send-to” button, then scroll right in the row of apps and tap “Copy to ForeFlight”. Or touch-hold on the attachment (such as a PDF) then scroll right in the row of apps and tap “Copy to ForeFlight.”

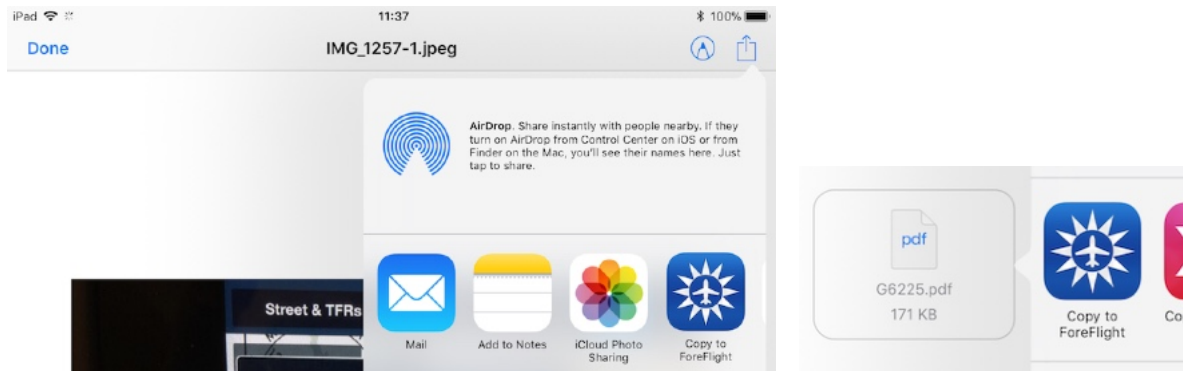

❖ **Importing from Dropbox app** - open the Dropbox app, tap the file, tap the 3-dot “menu” button in the upper-right, then choose Export.

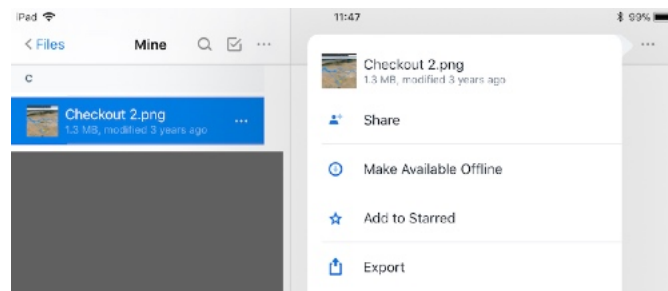

In the bottom row of options, choose "Open In...". Scroll right in the row of apps then tap "Copy to ForeFlight"

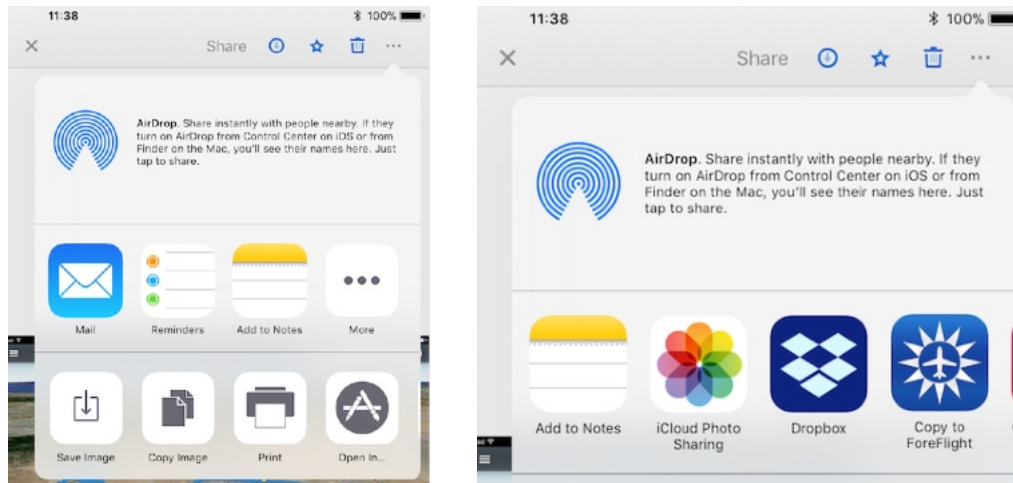

❖ **Importing from GMAIL app** - open Gmail, open the message, tap the attachment, then tap the Send-to button, and tap "Copy to ForeFlight"

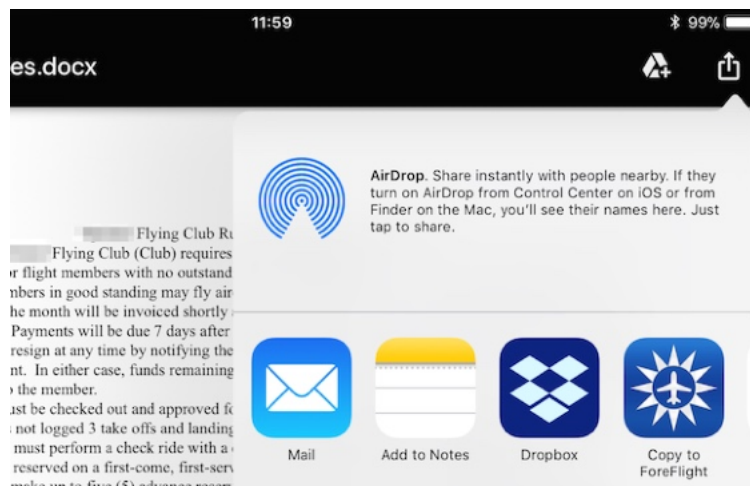









If a document does not import, make sure it is a supported file format: PDF, JPG, TIF, PNG, GIF, or Microsoft Office. Very large image files or PDF files containing scanned images may open slowly, especially on earlier iPad models.

After a document is imported, it is always added to the Imported Drive. To also add an imported document to a Binder, open the Document, tap the **Binder** button at the top right, and select one or more Binders from the list.

Viewing a Document

Tap any document thumbnail to open it. The document viewer supports standard pinch and expand zooming, and panning touch gestures. Swipe left and right with a single finger to change pages. You can close the document by pinching (zoom out gesture) from the view on any page and you can open a document by expanding (zoom in gesture) from the Drive or Binder view.

Tap once on a document page to bring up the toolbar at the top and page scrubber at the bottom. Tap again on the document to hide these overlays.

	Settings: shows the screen brightness slider, and the Invert Document Colors switch for better low-light viewing of documents.
 	Toggles between full page view and thumbnail view, which shows a thumbnail for each page in the document. This button is only shown for PDF documents.
	Display the Annotation menu. This button is only shown for PDF documents
	Add the current document to an existing or new Binder
	Search/Contents/Bookmarks. Search for text in the document, Show the Table of Contents, and show Bookmarks
	Bookmarks a page in the document. This button is only shown for PDF documents.
	Shows a menu for Printing or Emailing a document. Emailing is not available for certain copyrighted document catalogs.
	Disables touch interaction (zooming and scrolling), which minimizes the risk of accidental closure when in turbulence. It also disables the automatic rotation that would normally occur when the iPad is turned. The lock button can also, optionally, disable all buttons on the screen, including those that change views. That feature is configured in Settings ("Lock Disables Buttons").

Document View Toolbar Buttons

At the bottom of the screen, the page scrubber shows thumbnails for each page and lets you quickly jump around in your document.

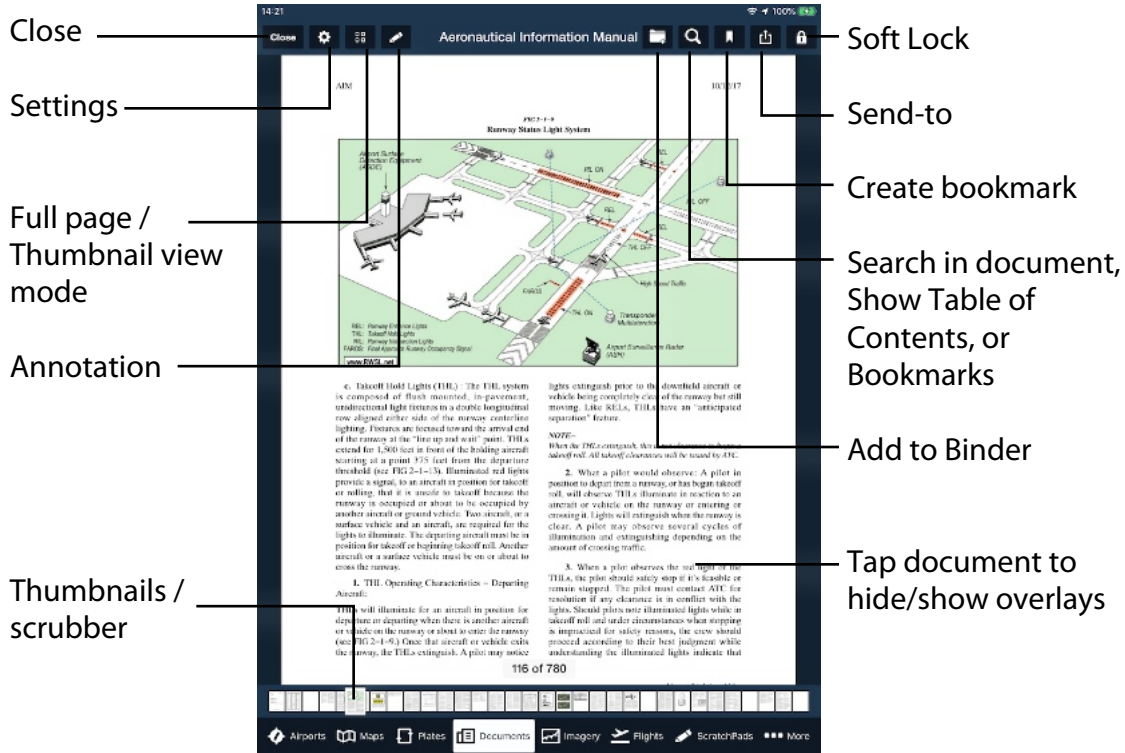

Searching for a Document

ForeFlight Mobile's unified App Search allows you to search for document titles across the Documents as well as Airports, Maps, and Plates tabs. When searching on the Documents tab, Document title matches show up as the first category in the results. When searching on other tabs, scroll down to find Document results. To [search text inside a PDF document](#), open the document and tap the search button (see below).

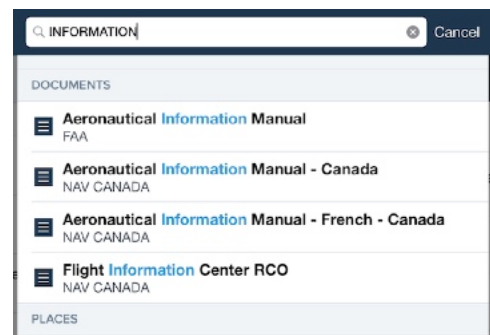

Searching in a Document

Tap the Search button  to display the search box, then enter your search term(s). All matches will be shown in the scrollable expanding list. Tap the entry to jump to the desired page, where the search term(s) will be highlighted in yellow.

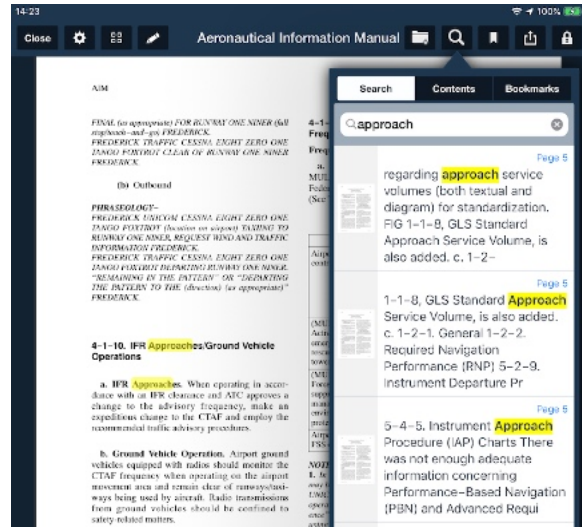

Adding and Removing Bookmarks

While viewing the page you would like to bookmark, tap the Bookmark button  then enter the name you would like to give the bookmark and tap the “Add Bookmark” button. View all bookmarks for the current document by tapping the “Search” button and choosing the Bookmarks filter.

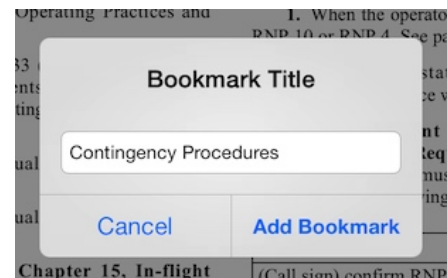

To remove a bookmark, tap the “Search” button, choose the Bookmarks filter, then swipe-delete the bookmark you want to remove: swipe your finger across the title, then tap the red “Delete” button. Or you can tap on the bookmark you want to remove to change to that page of the document. When that page is displayed, tap the bright-blue Bookmark button to remove the bookmark.

Ensuring Your Documents Don't Expire

When a new version of a document is available, a red badge will appear on the app icon and there will be a new item in the Downloads view. Tap the blue **Download** button at the bottom of the Downloads view to download the latest documents, along with any other data updates that are available.

Documents from providers such as the FAA, NAV CANADA, and Eurocontrol, that are updated on a regular 28-day or 56-day cycle will be available for download a few days before the document expires. Once the new version of a downloaded document becomes effective, any old, expired versions will be deleted from your device.

Annotating Plates and PDF Documents

About the Design

This feature allows you to add your own full-color annotations to Approach plates, SID, STARs, Airport Diagrams and PDF Documents. This can be useful for highlighting important elements such as crossing altitudes or taxi instructions, or adding notes to your PDF documents.

Annotations are available in all subscriptions. If you have a ForeFlight Pro Plus, Performance Plus, Business Pro, or Business Performance subscription, annotations you make on an Approach plate are displayed when you show the annotated [Plate on the Map](#).

Annotations you add to a Plate, SID, STAR or Airport Diagram are saved at the data cycle change-over, unless the SID, STAR or Plate name changes in the new data cycle (e.g., if the TEXN5 STAR becomes TEXN6, or RWY03 ILS becomes RWY04 ILS due to updated magnetic variation).

Annotations you add to a PDF Document are synchronized between all signed-in devices, and are saved if the document is updated provided the document title stays the same during the update.

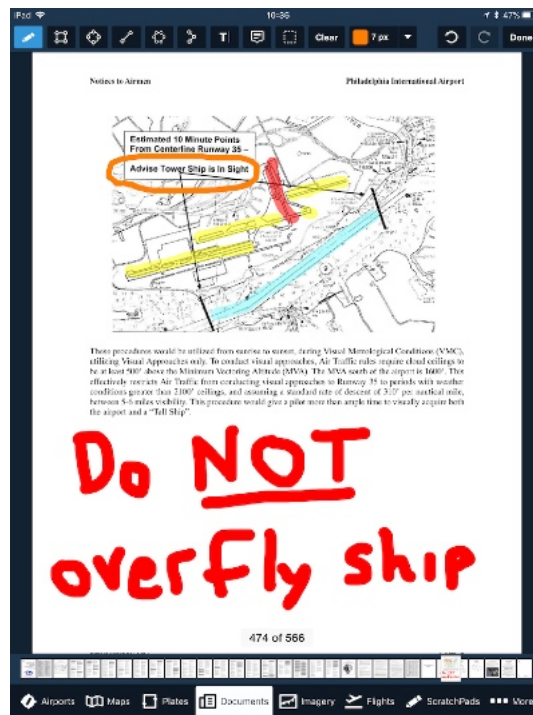





Types of Annotations

There are 8 kinds of annotations available on the iPad:

Drawing 		Text Box 	
Rectangle 		Ellipse 	
Line 		Polygon 	
Polyline 		Sticky-note 	

All annotations made on an iPad are visible on an iPhone. However there are only 3 kinds of annotations available to be created on the iPhone:

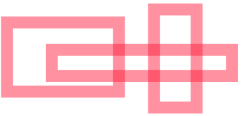
Drawing 		Text Box 	
Rectangle 			

Adding and Editing Annotations

When you open a plate or PDF Document, tap the Annotation button  in the menu at the top of the page to display the annotation toolbar:

iPad



Or simply touch-hold on the plate or PDF Document until the magnifying glass appears, then release your finger to display the popup Annotation menu:



Tap the button to choose the type of annotation you want to add (Text, Sticky note, or Ink drawing), then adjust the formatting and color of the annotation (if needed) by tapping the colored Annotation setting button (the colored dot) at the top of the page.

iPhone

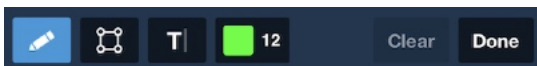

The iPhone allows you create freehand drawings, rectangles, and text-box annotations, but you can view all annotations created on an iPad.

You can reposition an annotation by touch-dragging inside of the selection box. and you can resize the annotation by touch-dragging one of the blue “handles” around the annotation.

Choosing Annotation Color

Tap the Color drop-down in the top menu bar to display the line Color, Opacity, and Thickness picker.

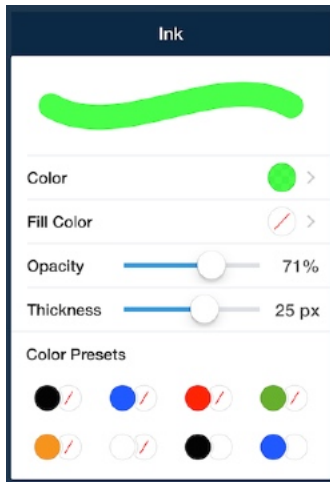

You can choose from 8 presets: six with transparent “fill” colors (with the red /) and two with white fill.

Or tap the Color button to display the color picker. Change between the 5 color selection pages by swiping from left to right.

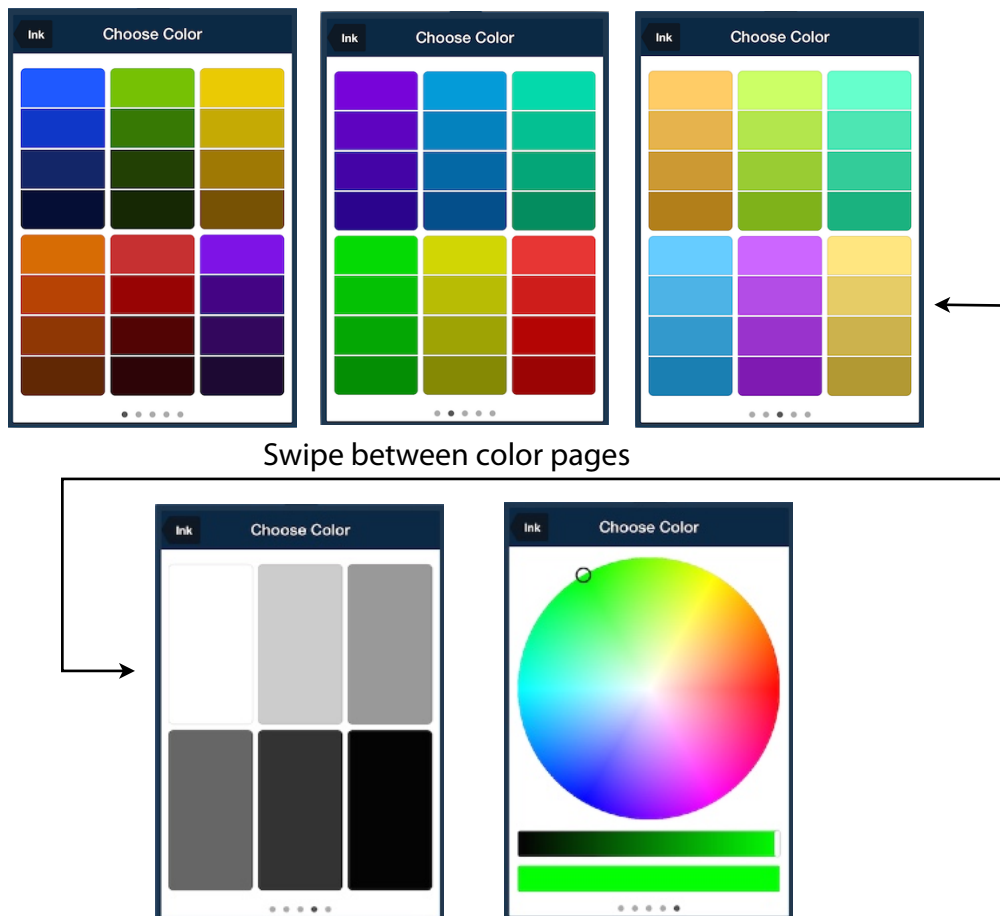

When using the color “circle”, touch in the circle to choose the color you want, then slide the horizontal slider below the circle to adjust the brightness of the color.

Fill Color: Transparent or “No Fill”

To choose a transparent or “no fill” color, select the Fill Color box with the red diagonal line.

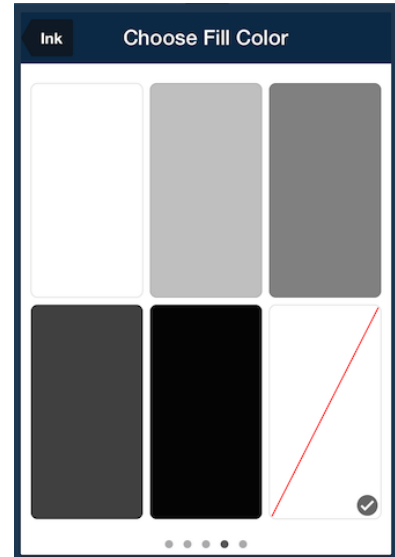

Drawing/Ink

The freehand Drawing/Ink tool allows you to choose the line Color, Opacity and Thickness. To edit a previously drawn line, tap it, then choose the “Inspector” menu.

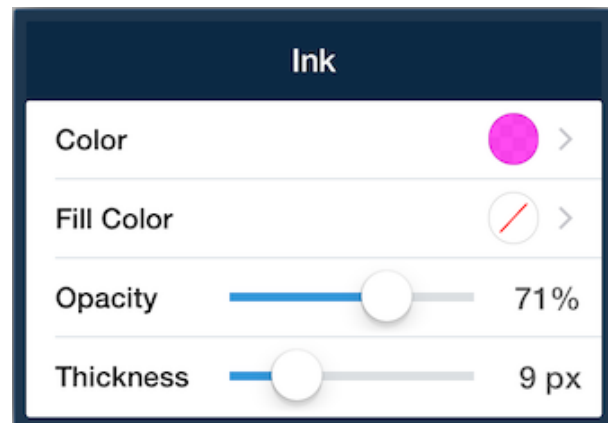
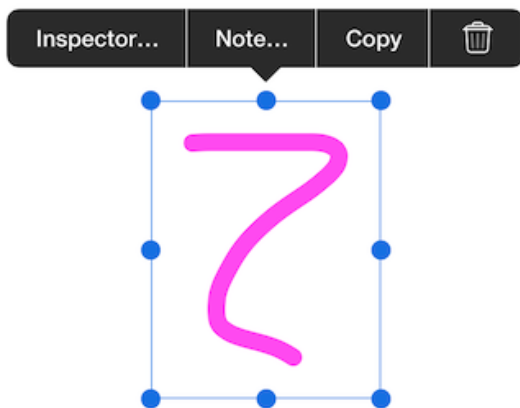

Text Box

The Text Box tool lets you pick the Text Color, the Text Box fill Color, the Opacity, the Font (Font style in a sub-menu), Font Size, text alignment, and whether a Callout line + arrow are automatically attached to the text box.

To create a text box, select the Text Box tool, tap on the Plate or Document where you want the text to appear, then type the desired text. When typing into a text box, several formatting options are available at the top of the on-screen keyboard:

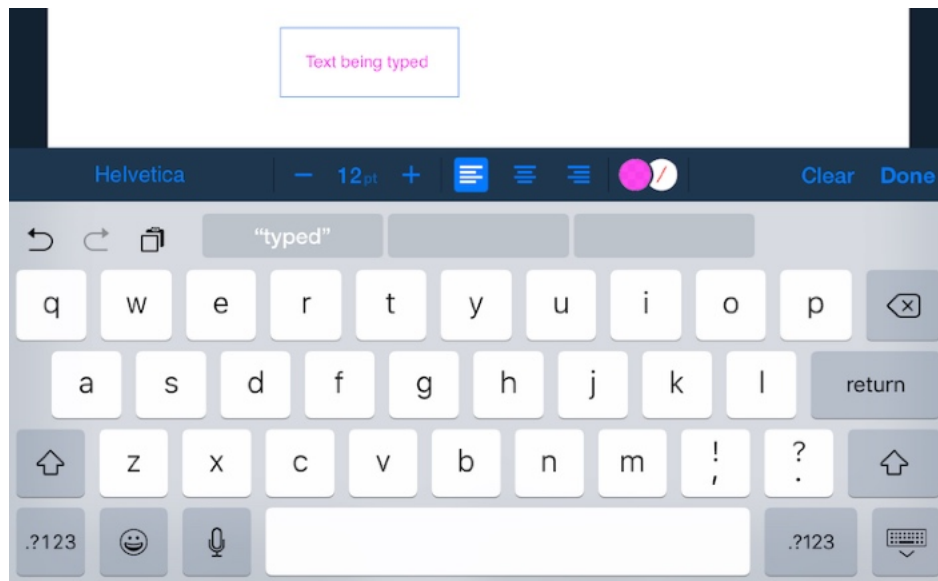

To edit a previously drawn text box, tap it, then choose the "Inspector" menu, then tap the attribute you want to change.

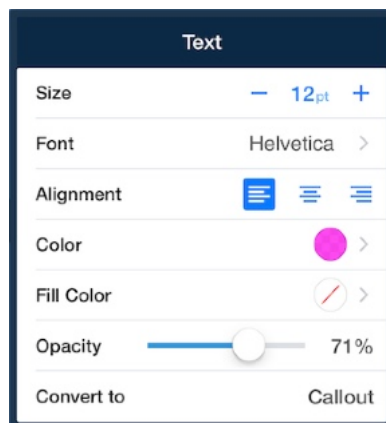

If converting the Text Box to include a Callout line + arrow, tap "Callout" in the Convert to line, then choose the Line End type.

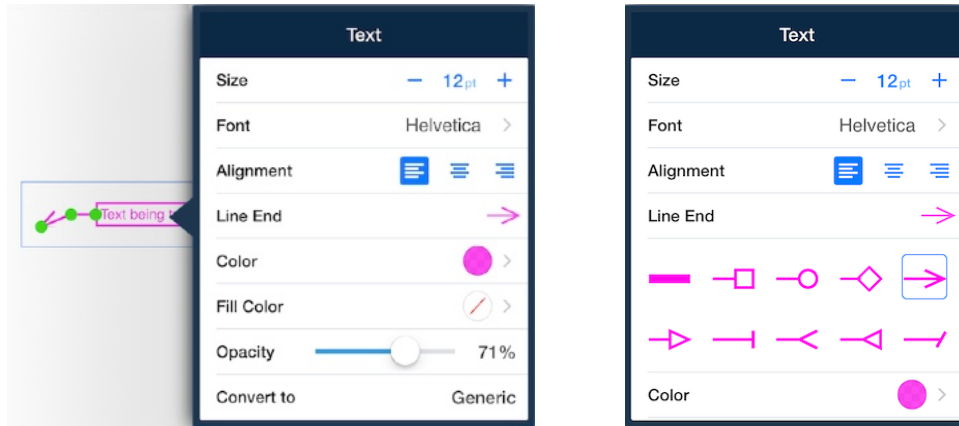

You can reposition the callout line by touch-dragging on the green “corner” points.

Rectangle

The Rectangle tool allows you to choose the line and Fill Color, rectangle Opacity and line Thickness. To draw a rectangle, touch-hold then drag your finger to make the rectangle. Lift your finger to complete the drawing. To edit a previously drawn rectangle, tap it, then choose the “Inspector” menu.

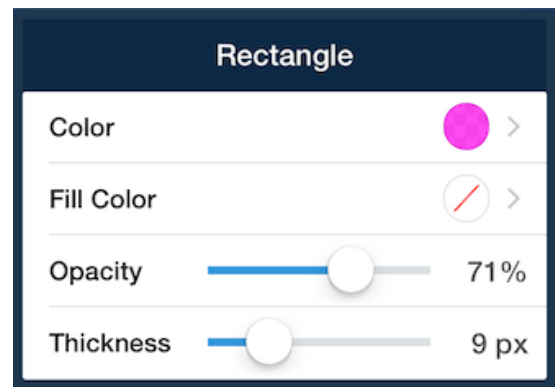

Ellipse (Circle)

The Ellipse tool allows you to choose the line and Fill Color, ellipse Opacity and line Thickness. To draw an ellipse, touch-hold then drag your finger to make the ellipse. Lift your finger to complete the drawing. To edit a previously drawn ellipse, tap it, then choose the “Inspector” menu.

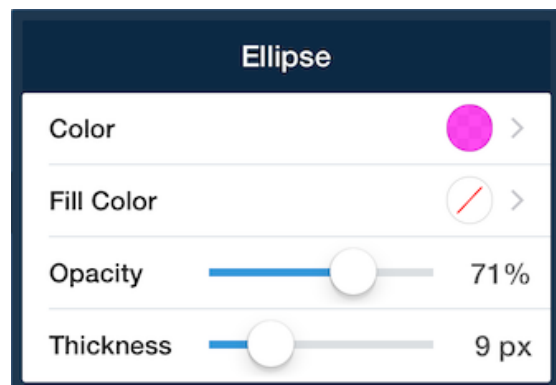

Line

The Line tool allows you to choose the line Color, Opacity, Thickness as well as start and end-point type (e.g., arrow, dot, diamond, etc...). To draw a line, touch-hold

then drag your finger to make the line. Lift your finger to complete the drawing. To edit a previously drawn line, tap it, then choose the “Inspector” menu.

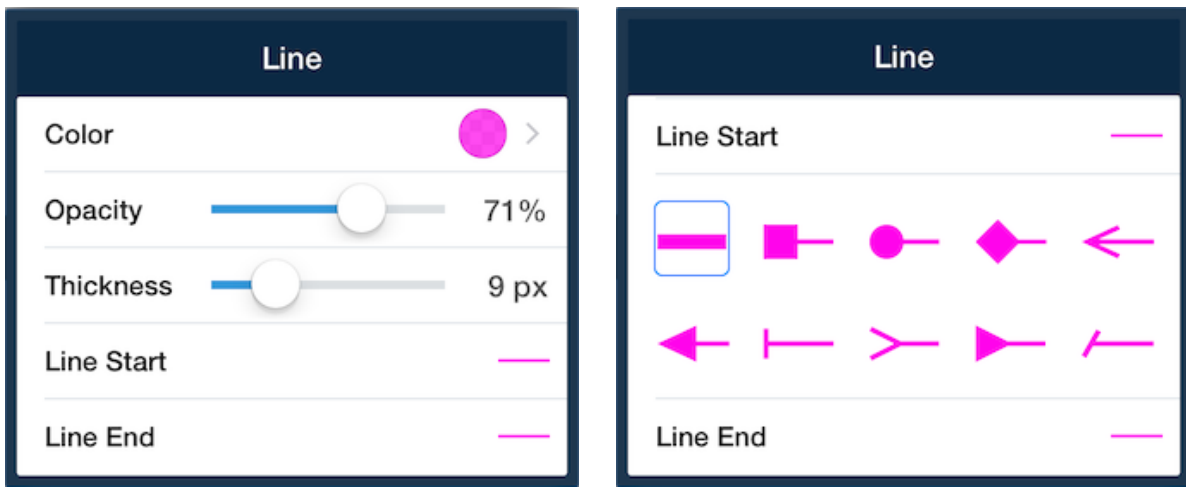

Polygon

The Polygon tool lets you choose the line and Fill Color, polygon Opacity and line Thickness. To draw a polygon, tap your finger to each desired “corner” of the polygon. Each additional tap will extend a line segment from the previous corner to the new tap. When you tap “Done” in the menu bar, a final line segment will automatically be added to “close” the polygon.

To edit a previously drawn polygon, tap it, then choose the “Inspector” menu.

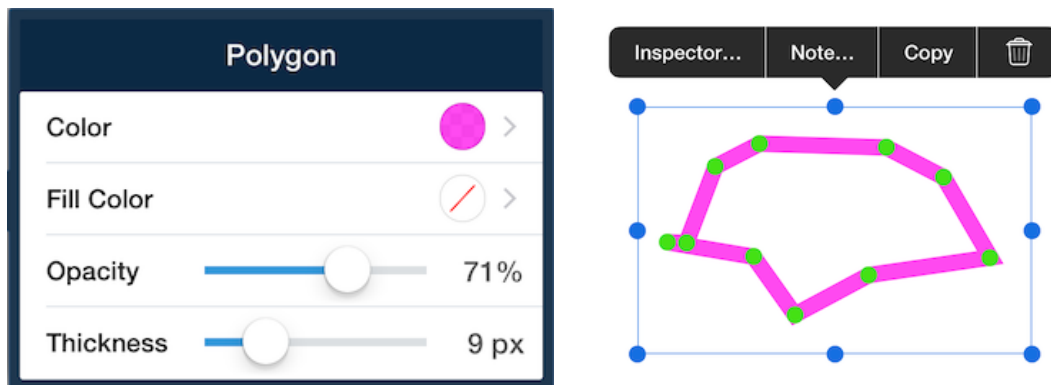

You can edit the corners of the polygon by touch-dragging the green “corner” point handle to the desired corner position.

Polyline

The Polyline tool is similar to the Polygon tool, except that the shape is not automatically “closed” when you tap “Done”, and like the Line tool you can choose the start and end-point types (e.g., arrow, dot, diamond, etc...).

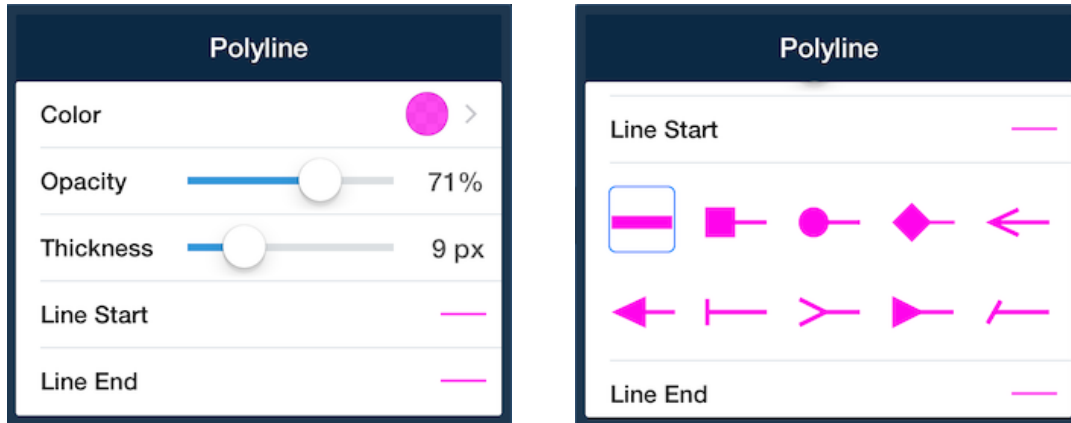

To edit a previously drawn polyline, tap it, then choose the “Inspector” menu.

Sticky-note

Tap the note icon, then tap the “Edit” button to choose the note background color and icon type. Tap anywhere not on the Sticky-note to close the Edit menu.

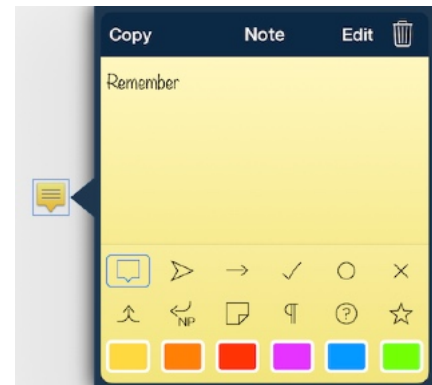

Undo/Redo

While adding annotations to a Plate or Document, tap the Undo (left) arrow button to remove recent annotation elements, and tap the Redo (right) arrow button to restore removed annotation elements.



Selecting Multiple Annotations

Tap the Selection button  then touch-drag across multiple annotations to select several at once, then tap Group to group the items together, Copy to copy all items, or the Trash can to delete the selected annotations.

Copying and Pasting an Annotation

Tap a previously added annotation to select the annotation and display the edit popup menu, then tap the Copy button.



Paste the copied annotation in a different location or onto a different page (or document) by touch-holding on the Plate or Document until the magnifying glass appears. Lift your finger, then tap the Paste button in the popup Annotation menu.

Deleting Annotations

Tap the annotation to select it, then tap the Trash-can button in the edit popup menu.

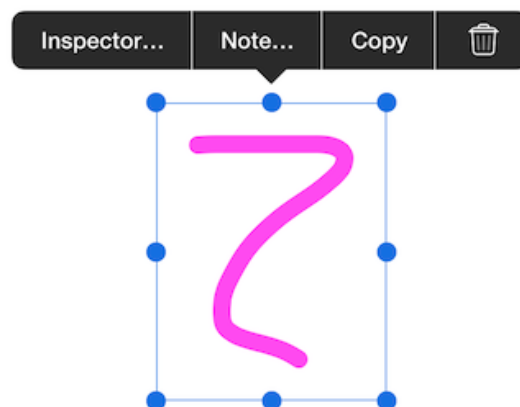

To remove all annotations from a page, tap the Annotation button , then tap Clear.

Imagery

About the Design

The Imagery view provides collections of weather images from around the globe. Images are divided into categories by type. When viewing a category a current thumbnail image is shown for each available image.

Full size images are displayed full screen and support standard pinch and expand zooming, and panning touch gestures.

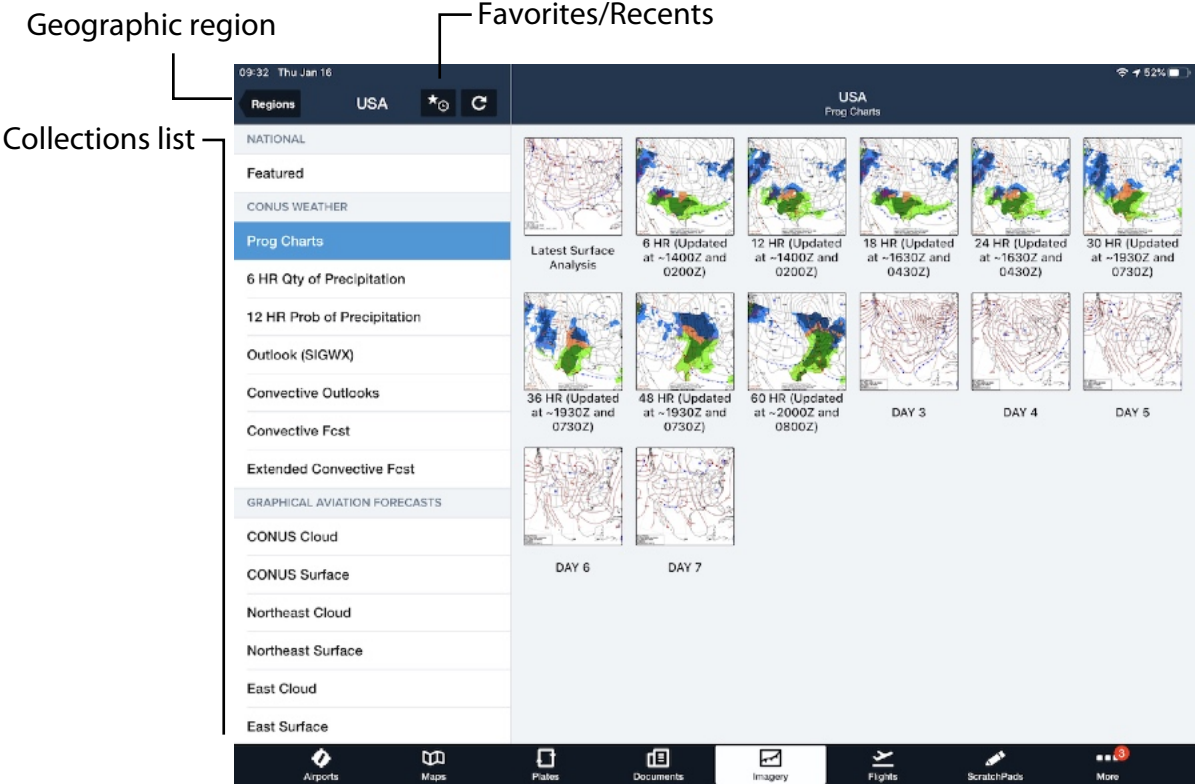

Selecting a Collection

Tap a collection in the left-side list to show thumbnails from that set on the right side. Other collections are available by tapping the USA/Global geography selector at the bottom of the list.

In addition to the previous Imagery selections, ForeFlight Mobile 7.1 adds several new Imagery Collections and chart types:

NATIONAL - Featured

Flight Category - Updated once every 30 minutes, the flight category chart highlights adverse flight conditions affecting the conterminous U.S. and southern Canada. Using colored dots this chart depicts the lowest flight category considering both ceiling and visibility for stations reporting marginal VFR (blue), IFR (red) or low IFR (magenta). Also included are recent pilot weather reports of moderate or greater turbulence (tan) and moderate or greater icing (green) using standard pilot report symbology.

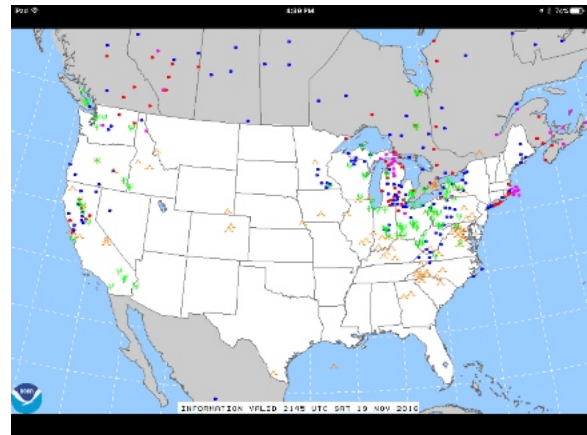

Latest Surface Analysis - The mean sea level (MSL) surface analysis chart is issued every three hours by a forecaster at the Weather Prediction Center (WPC). This chart depicts the synoptic and sub-synoptic/mesoscale features including the location of high and low pressure centers, fronts, troughs, outflow boundaries, squall lines, dry lines and an isobaric analysis. The domain includes much of North America, the Western Atlantic and Eastern Pacific oceans and the Gulf of Mexico. This analysis is valid at the synoptic times of 0000 UTC, 0300 UTC, 0600 UTC, ..., 2100 UTC. The latest surface analysis becomes available approximately 1 hour and 30 minutes after these synoptic times.

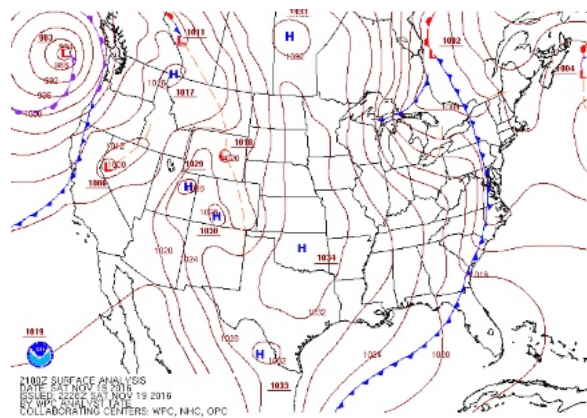

Today's Forecast - The Weather Prediction Center (WPC) National Forecast Chart provides an overview of expected weather for today, with emphasis on certain hazardous and significant weather. They summarize forecasts from several of the National Centers for Environmental Prediction (NCEP) Service Centers including the Storm Prediction Center (for severe thunderstorm and tornado outlooks), the National Hurricane Center (for tropical storm and hurricane forecasts), and the Weather Prediction Center (for information concerning heavy rainfall, flooding, winter weather, and general weather). With overlaid frontal forecasts, these displays serve as a good overview of the expected weather for today.

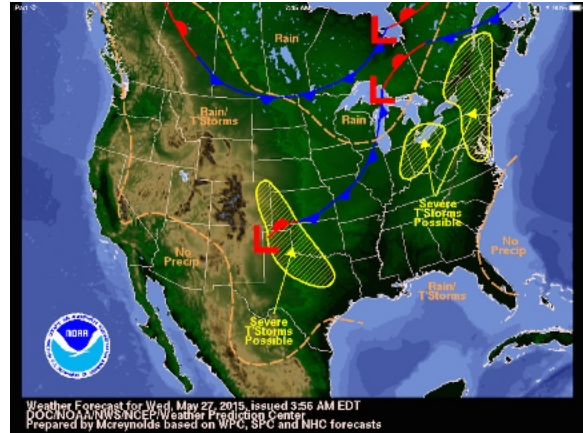

CONUS WEATHER

Prog Charts - The Prog Chart collection contains the latest surface analysis chart which is updated once every three hours. This is not a forecast, but represents the latest surface conditions valid in the recent past. This collection also contains short and extended range forecasts that are also known as "prog" charts. Short range forecasts are updated at various times throughout the day as labeled below each thumbnail image.

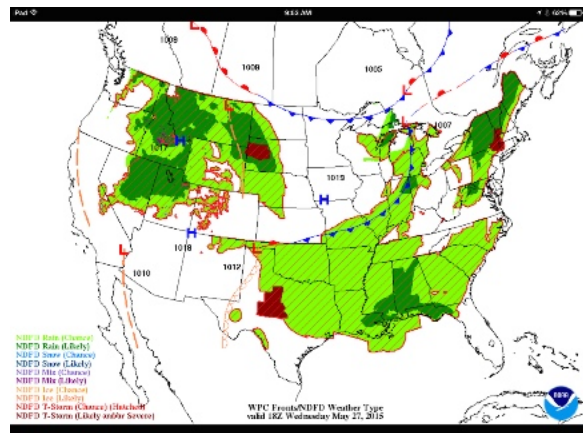

The primary goal of the short range forecasts are to depict the evolution of major weather systems that will affect the conterminous U.S. during the next 60 hours. These forecasts combine the Weather Prediction Center (WPC) forecasts of surface fronts, MSL pressure (isobars) and high/low circulation centers along with a depiction of the expected weather type (precipitation). The precipitation forecast shown on this chart defines expected coverage and is valid at the time on the chart (not over a range of time).

Prog charts use the following colors to depict different weather types (precipitation):

- **Rain (Chance)** - There is chance of measurable rain ($\geq 0.01"$) at the valid time.

- **Rain (Likely)** - Measurable rain (≥ 0.01 ") is likely at the valid time.
- **Snow (Chance)** - There is chance of measurable snowfall (≥ 0.01 " liquid equivalent) at the valid time.
- **Snow (Likely)** - Measurable snow (≥ 0.01 " liquid equivalent) is likely at the valid time.
- **Mix (Chance)** - There is a chance of measurable mixed precipitation (≥ 0.01 " liquid equivalent) at the valid time. "Mixed" can refer to precipitation where a combination of rain and snow, rain and sleet, or snow and sleet are forecast.
- **Mix (Likely)** - Measurable mixed precipitation (≥ 0.01 " liquid equivalent) is likely at the valid time. "Mixed" can refer to precipitation where a combination of rain and snow, rain and sleet, or snow and sleet are forecast.
- **Ice (Chance)** - There is a chance of measurable freezing rain (≥ 0.01 ") at the valid time.
- **Ice (Likely)** - Measurable freezing rain (≥ 0.01 ") is likely at the valid time.
- **T-Storm (Chance)** - There is a chance of thunderstorms at the valid time. Areas are displayed with diagonal hatching enclosed in a dark red border.
- **T-Storm (Likely and/or Severe)** - Thunderstorms are likely and/or the potential exists for some storms to reach severe levels at the valid time.

Extended range Progs are also prepared by forecasters at the WPC. A new extended range forecast is issued daily around 0330 UTC and updated again at 1500 and 1900 UTC. Only surface fronts, MSL pressure (isobars) and high/low circulation centers are depicted from 72 hours (Day 3) through 168 hours (Day 7). Each forecast is valid at 1200 UTC. A forecast of instantaneous precipitation is not depicted on extended range Progs.

6 HR Quantity of Precipitation -

Quantitative Precipitation Forecasts, or QPFs, issued by forecasters at the Weather Prediction Center (WPC) depict the amount of liquid precipitation expected to fall in a defined period of time, in this case, six hours. Valid times are shown in the lower left. In the case of snow or ice, QPF represents the amount of liquid that will be measured when the precipitation is melted. It is important to recognize that QPF does not forecast the precipitation type or whether

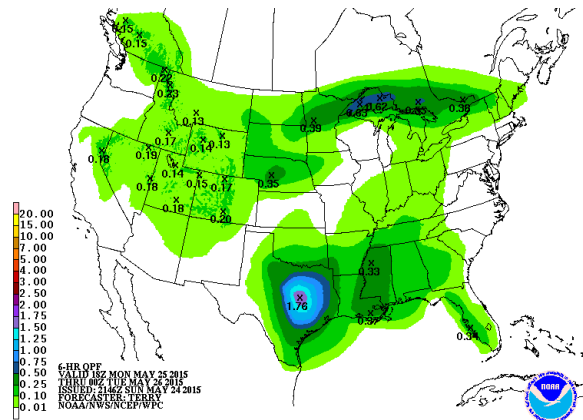

or not the precipitation will be from convection. It is solely used to forecast the amount of precipitation over a given location in inches using solid colored contours based on the legend on the lower left of the chart. An "X" on the chart simply defines a local maximum precipitation amount within a contoured area. Keep in mind that precipitation amounts can vary significantly over short distances, especially when thunderstorms occur, and for this reason QPFs issued by the Weather Prediction Center (WPC) are defined as the expected "areal average."

12 HR Probability of Precipitation -

The Probability of Precipitation (PoP) forecast issued by forecasters at the Weather Prediction Center (WPC) depicts the chances of precipitation over a 12 hour forecast period for the next three to seven days. Probabilities are contoured using solid colors as shown in the legend at the bottom of the chart. Numbers shown on the map represent a probability for a particular city over the valid forecast period.

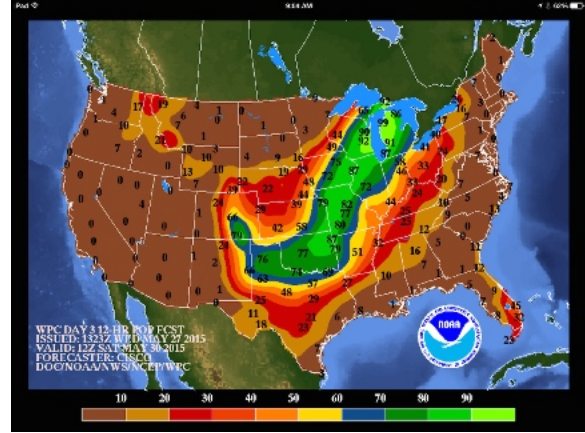

Important: The valid time in the lower left defines the ending time of the 12 hour forecast period. For example, a forecast valid at 00Z on February 13th would include the period from 12Z February 12th to 00Z February 13th.

Outlook (SIGWX) - The low-level SIGWX graphics is a forecast of aviation weather hazards, primarily intended to be used as a guidance product for briefing VFR pilots. The forecast domain covers the conterminous U.S. for altitudes below 24,000 feet (400 mb). These charts are issued four times a day and are valid at 0000 UTC, 0600 UTC, 1200 UTC and 1800 UTC. Each issuance includes both a 12 and 24 hour forecast depicting the freezing levels (dashed cyan), turbulence (dashed orange), and low cloud ceilings and/or restrictions to visibility shown as contoured areas of marginal VFR (blue) and IFR conditions (red). A two-panel chart is also provided that presents the 12 and 24 hour forecasts in the same image.

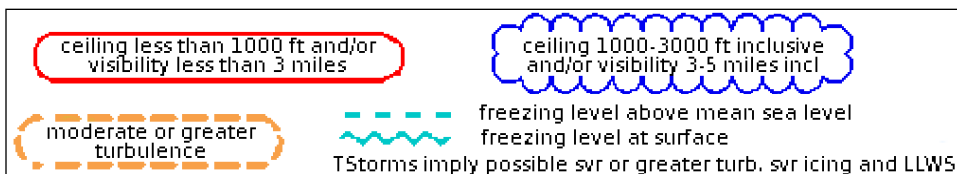
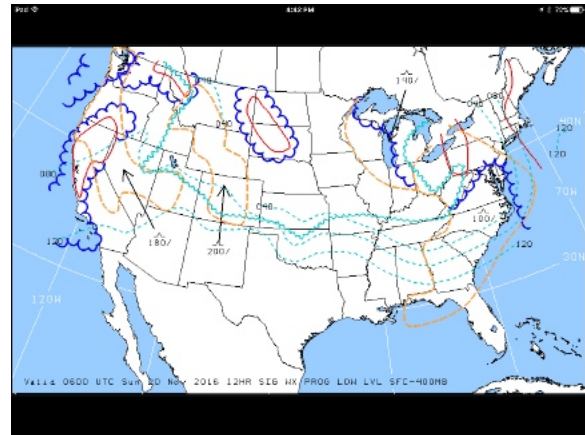

Convective Outlooks - The convective outlooks issued by forecasters at the Storm Prediction Center (SPC) provide an overview of areas that may experience thunderstorms over the next eight days with emphasis on the location of severe convection. Included in this collection are the latest severe thunderstorm (blue) and tornado (red) watch areas along with categorical and probabilistic forecasts for Day 1 (today), Day 2 (tomorrow), Day 3 (the day after tomorrow) and a categorical forecast for severe thunderstorms only for Day 4 through Day 8. Colored contours are shown to depict the threat risk of severe thunderstorms as shown in the legend below. Additionally for Day 1, a probabilistic forecast for tornadoes, large and damaging hail and strong and gusty winds is included.

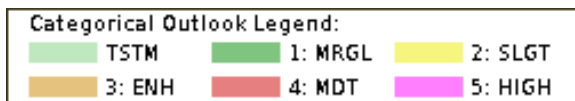
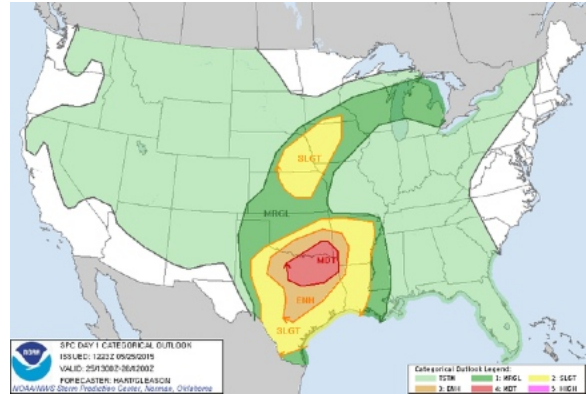

Convective Forecast - The Collaborative Decision Making (CDM) Convective Forecast Planning (CCFP) guidance is a graphical representation of convection meeting specific criteria of coverage, intensity, echo height, and confidence. CCFP graphics are produced every two hours and is valid at 2-, 4-, 6-, and 8-hours after issuance time. This forecast is generated automatically and does not use the same criteria as is used for issuing convective SIGMETs. Hatched contours include sparse coverage-low confidence, sparse coverage-high confidence and medium coverage-high confidence. A forecast for echo tops is also included. Keep in mind this is not a maximum tops forecast. This is best used for strategic planning purposes for aircraft making longer flights at altitudes above FL250.

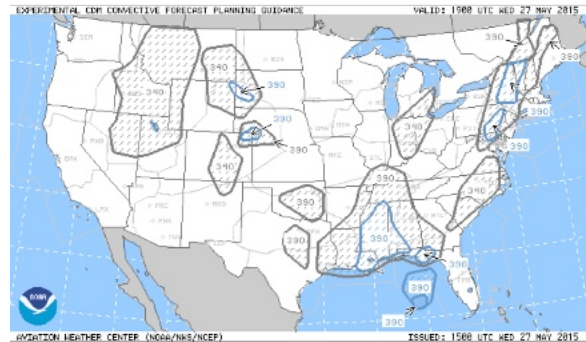

		CONFIDENCE:		HEIGHT	
		LOW	HIGH	TOPS: 100's OF FEET MSL	
		25-49%	50-100%	25000 - 29000	290
CONVECTIVE COVERAGE:	SPARSE 25-39%			30000 - 34000	340
	MEDIUM+ 40-100%			35000 - 39000	390
				40000+	>400

Extended Convective Forecast- The Extended CDM Convective Forecast Planning (CCFP) planning tool is a graphical representation of the forecast probability of thunderstorms. This forecast is automatically generated and identifies where thunderstorms are likely over the next 78 hours. It is important to note that this is not a precipitation forecast. Areas outside of the shaded contours could contain areas of precipitation that are not as likely to be convective. Contours are shaded on based on convective probability as shown in the legend below.

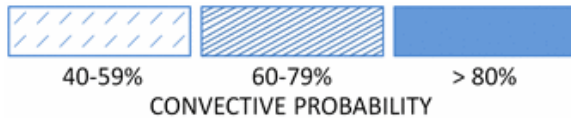

GRAPHICAL AVIATION FORECASTS

In late 2019 NOAA discontinued distribution of the **GFS MOS Ceiling Forecast** and **Visibility Forecast** Graphical products.

ForeFlight now provides the Graphical Aviation Forecasts for Cloud Coverage and Surface Conditions. The forecasts are provided for CONUS and nine additional regions, for 6 forecast periods up to 18 hours in the future.

The Cloud Coverage product depicts the degree of cloud coverage (few, scattered, broken, or overcast) as well as cloud top altitudes and icing or mountain obscuration AIRMETS.

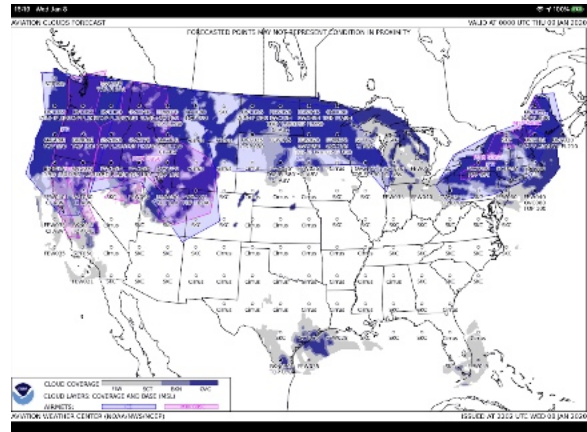

The Surface product depicts obscuration hazards and types (haze, fog, smoke, or dust/sand), weather conditions with color-coded probabilities (rain, snow, mix, or ice), thunderstorm probabilities, surface visibility, IFR or surface wind AIRMETS, and surface wind barbs with gust speeds indicated by red extensions on each barb's tail.

The Surface product utilizes the METAR weather symbols; a few common ones are

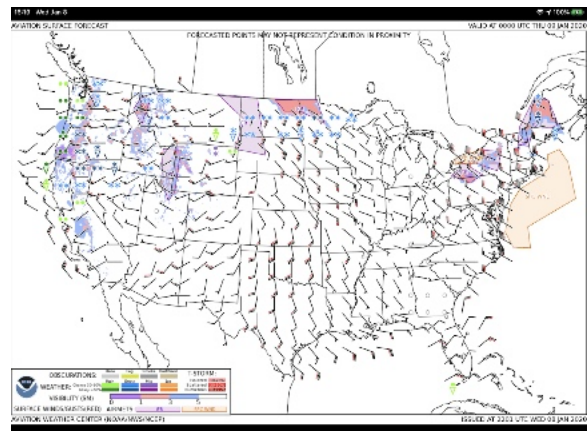

listed here for quick reference. For a complete list, see the "Weather Legends in ForeFlight Mobile" in Documents > ForeFlight.

	BR: Mist or light fog		VCSH: Vicinity Showers
	DZ: Moderate drizzle		SHRA: Moderate rain showers
	SN: Moderate snow		RA: Moderate Rain
	-FZRA: Light freezing rain		TSRA: Light to Moderate thunderstorm with rain

ADVISORIES

Graphical AIRMETS - Also known as G-AIRMETS, Graphical AIRMETS provide a graphical representation of en route advisories for adverse weather including IFR conditions and mountain obscuration, turbulence, icing and freezing level. Graphical AIRMETS are issued by the same forecasters at the Aviation Weather Center (AWC) that issue the legacy AIRMET and Area Forecast (FA). Forecasts are issued four times daily at 0245Z, 0845Z, 1445Z and 2045Z. Graphical are amended as necessary. Unlike the legacy AIRMET that is valid over a six hour period with a six hour outlook, the Graphical AIRMET consists of five snapshots valid at three hour intervals out to twelve hours. The first three Graphical AIRMET snapshots including the Initial, 3 HR and 6 HR make up the same area as included in the legacy AIRMET.

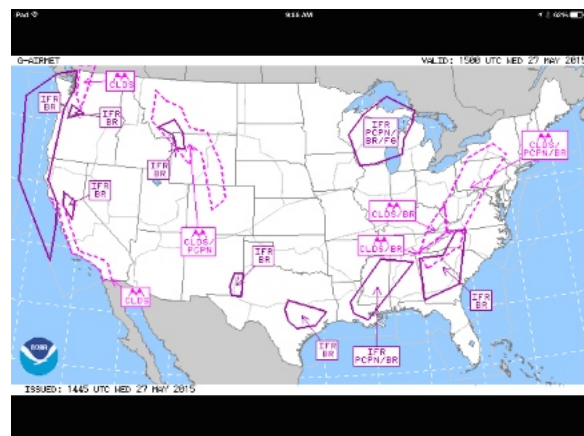

SIGMETs - These en route advisories are issued on an as-needed basis by forecasters at the Aviation Weather Center (AWC). They include advisories for convection, non-convective severe or extreme turbulence, non-convective severe icing, dust storms and sandstorms lowering visibility to below 3 miles and volcanic ash. When issued, these advisories are valid for a four hour period.



WINDS ALOFT

The winds aloft section provides two-dimensional graphics of winds at a multitude of altitudes from the initial time (analysis) with a lead time out to 48 hours. Standard wind barbs (direction and speed) are shown on each chart with the highest winds color contoured in knots using the legend at the bottom of the chart.

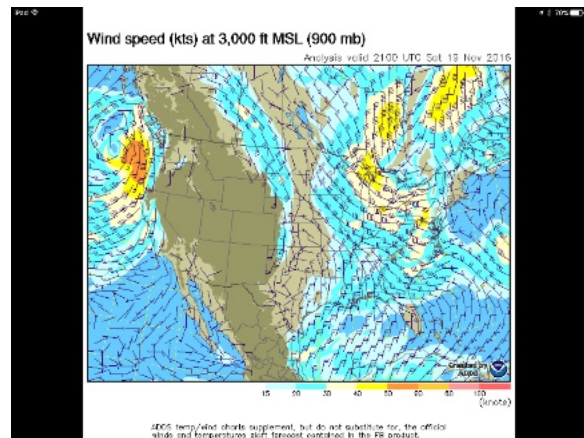

ICING

Lowest Freezing Level - Updated hourly, this includes both an analysis and forecast of the height of the lowest freezing level through the next 18 hours. The lowest freezing level is depicted at 2,000 ft increments in hundreds of feet above mean sea level (MSL) using the color scale at the bottom of the chart. Areas depicted in white consist of regions where the entire temperature profile above the surface is below 0 degrees Celsius. Hatched or stippled areas imply there are multiple freezing levels with the color presented in the hatched areas being the lowest of the multiple freezing levels.

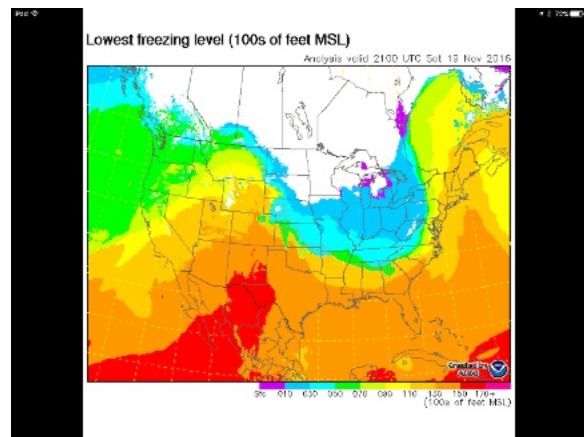

Icing Probability Analysis (CIP) - The Current Icing Product (CIP) combines a Rapid Refresh model forecast with the latest surface observations, visible and IR satellite, NEXRAD, lightning as well as pilot icing weather reports to describe an hourly, three-dimensional analysis of the icing environment using a calibrated probability. Probabilities are shown as percentages using the scale below. A new CIP analysis is generated hourly every 2,000 feet for altitudes from 1,000 feet MSL to FL290. Also a Maximum Icing Probability analysis is provided that is a composite of the maximum probability of all altitudes up to and including FL300. The hourly analysis becomes available about 20 minutes past each hour. Note that this is not a forecast, but a peek in to the recent past.

Maximum icing probability (1000 ft. MSL to FL300)
Analysis valid 1400 UTC Wed 27 May 2015

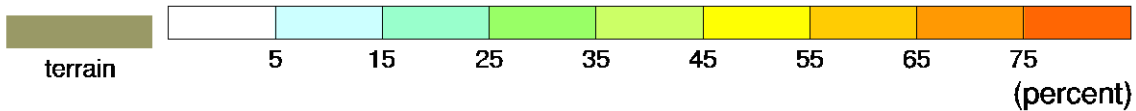
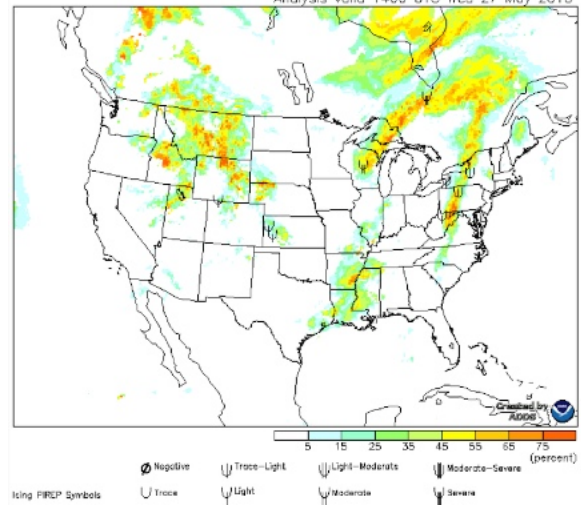

Icing Severity Analysis (CIP) - The Current Icing Product (CIP) combines a Rapid Refresh model forecast with the latest surface observations, visible and IR satellite, NEXRAD, lightning as well as pilot icing weather reports to describe an hourly, three-dimensional analysis of the icing environment using icing intensities. CIP Severity encompasses five categories represented by shades of blue to include trace, light, moderate and heavy as shown in the legend below. Additionally, overlaid on the severity chart is an analysis of the Supercooled Large Drop (SLD) potential shown in red hatching. A new CIP analysis is generated hourly every 2,000 feet for altitudes from 1,000 feet MSL to FL290. Also a Maximum Icing Severity analysis is provided that is a composite of the maximum intensity for all altitudes up to and including FL300. The hourly analysis becomes

Icing severity at 15000 ft. MSL
Analysis valid 1400 UTC Wed 27 May 2015

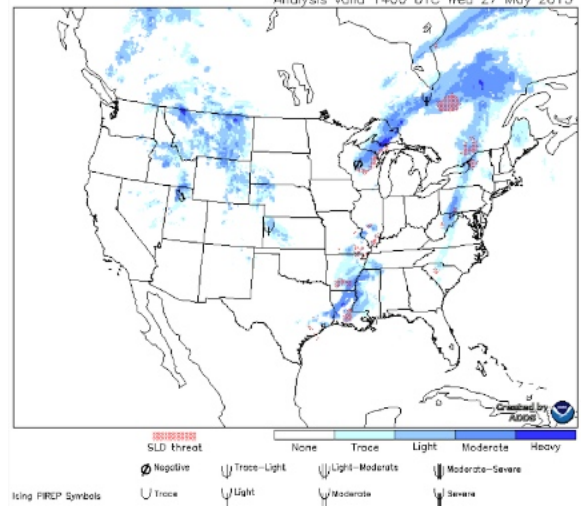

available about 20 minutes past each hour. Note that this is not a forecast, but a peek in to the recent past.

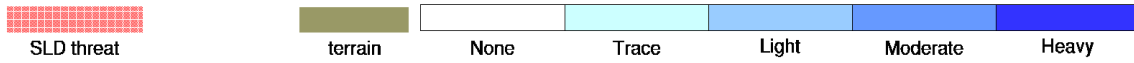

Masked Icing Severity > 25% (CIP) - The Current Icing Product (CIP) masked severity combines the CIP Probability and CIP Severity analyses. Shown in shades of blue are icing intensities with probabilities greater than 25 percent. Icing intensities in areas with less than or equal to 25 percent probability are masked and show up as light gray as shown in the legend below. This allows pilots to visualize the intensities for the icing environment with the highest probability. Note that Supercooled Large Drop (SLD) potential is not shown on this analysis.

Icing severity (prob>25%) at 15000 ft. MSL
Analysis valid 2200 UTC Wed 03 Jun 2015

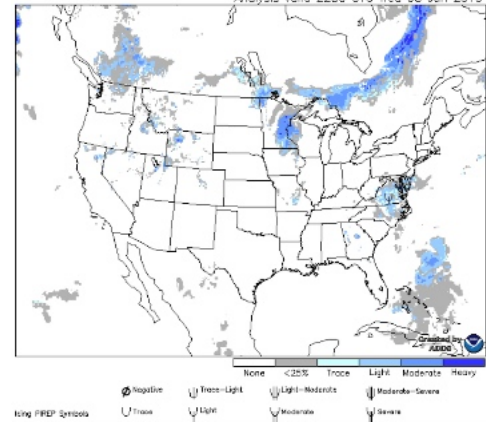

Masked Icing Severity > 50% (CIP) - The Current Icing Product (CIP) masked severity combines the CIP Probability and CIP Severity analyses. Shown in shades of blue are icing intensities with probabilities greater than 50 percent. Icing intensities in areas with less than or equal to 50 percent probability are masked and show up as light gray as shown in the legend below. Note that Supercooled Large Drop (SLD) potential is not shown on this analysis.

Icing severity (prob>50%) at 15000 ft. MSL
Analysis valid 2200 UTC Wed 03 Jun 2015

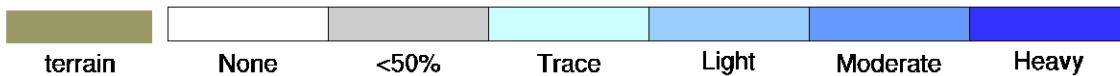
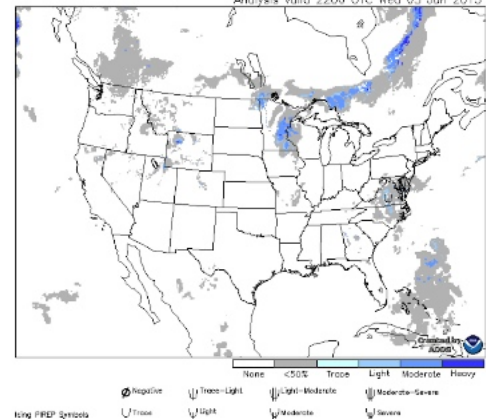

2, 3 and 6 HR Icing Severity Forecast -

The Forecast Icing Product (FIP) uses the Rapid Refresh model forecast to describe a three-dimensional forecast of the icing environment using icing intensities. FIP Severity encompasses five categories represented by shades of blue to include trace, light, moderate and heavy as shown in the legend below. Additionally, overlaid on the severity chart is a forecast of the Supercooled Large Drop (SLD) potential shown in red hatching. Forecasts are provide for 2, 3 and 6 hours.

Icing severity at 13000 ft. MSL

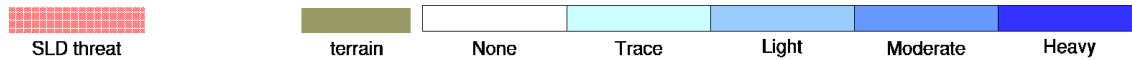
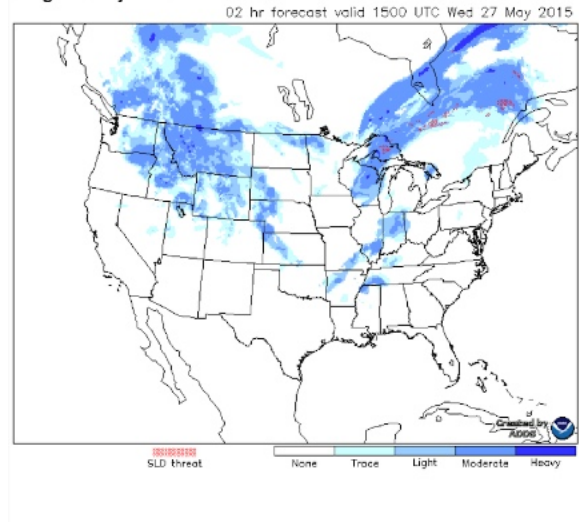

TURBULENCE

Graphical Turbulence Guidance - The Graphical Turbulence Guidance (GTG-3) includes an analysis and forecast for both clear air turbulence (CAT) and mountain wave turbulence (MTW), as well as an (All) section that combines them, with a new forecast updated every hour. The GTG includes turbulence from 1,000' to FL450 with a vertical resolution of 2,000'. Turbulence is measured in eddy dissipation rate (EDR), which is an objective measure of atmospheric energy dissipation, with larger numbers indicating a more turbulent atmosphere.

GTG - Max clear air turbulence (1000 ft. MSL to FL500)

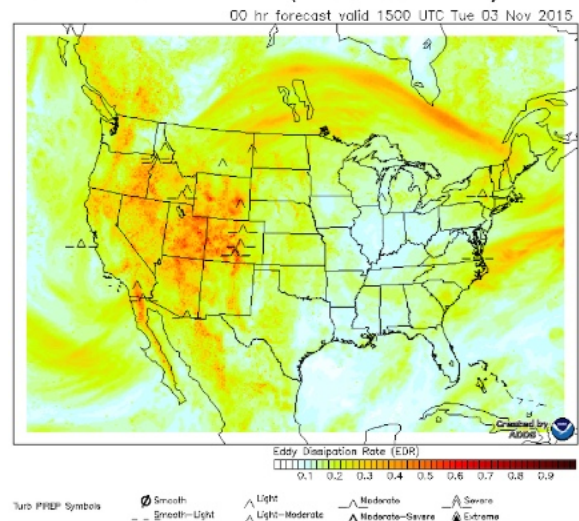

Eddy Dissipation Rate (EDR)



SATELLITE

Visible - The satellite imagery contains national and regional satellite images from the GOES-15 (West) and GOES-13 (East) satellites. These images are updated every 15 minutes. On the visible images clouds and snow appear bright white, but oceans, lakes and trees are much dimmer. After the sun has set and before the sun has risen, these images will be totally black leaving just the geopolitical boundaries.

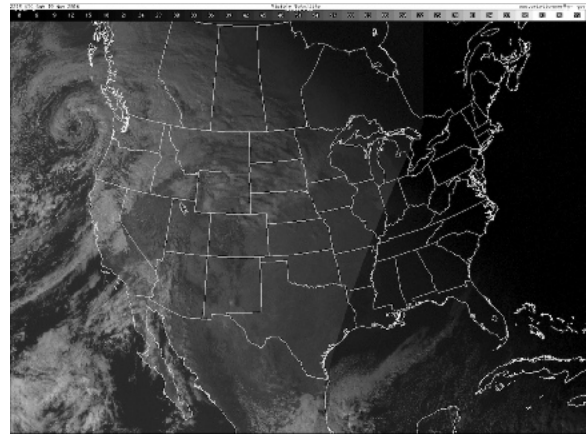

Infrared - The infrared satellite is a colorized depiction of temperature in degrees Celsius and is available during both the daytime and nighttime hours. The data measured by the satellite are calibrated and colorized according to this temperature with red shades representing warmer temperatures and blue shades representing cooler temperatures. Typically the temperature of the atmosphere decreases with increasing height. Therefore, using this depiction can give you an idea of which clouds are high-level and which are low-level based on the cloud top temperature. Keep in mind that with low-topped clouds near the surface, the temperature of the cloud tops can be actually a warmer than the temperature of the surface. Therefore, this depicts the temperature of the surface of the earth during clear skies or the temperature of the cloud tops.

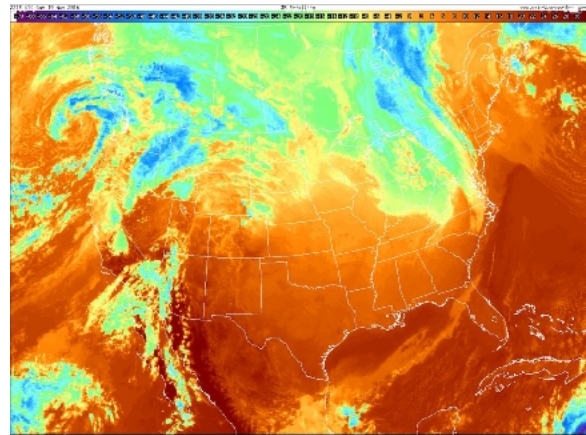

Additionally, cloud top temperatures of -15 degrees Celsius and warmer are typically dominated by liquid water. So temperatures that are in the range of yellow, pale green and sometimes light blue imply the potential for supercooled liquid water to exist in the clouds below, representing a significant airframe icing hazard.

DOPPLER RADAR

The Doppler radar static images and loops are regional/sector depictions of the national NEXRAD mosaic built from the lowest elevation angle base reflectivity data. Looped images are 10 minutes apart over the most recent one hour period. The reflectivity presented on these images has limited filtering to remove non-precipitation returns. As a result, during the early morning and overnight hours, it is quite common to see a significant amount of ground clutter and anomalous propagation depicted on these images and loops.

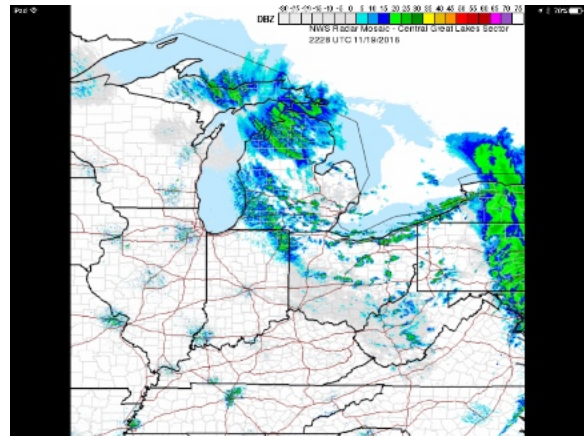

Also included is the national radar summary chart. This chart is created from what is called the Radar Coded Messages (RCMs). The RCM reflectivity data has spatial resolution of about 12 km and is updated every 30 minutes. The numbers on this image represent the maximum tops for each radar's area of coverage. Please note that some of the tops reported on this graphic are often erroneous.

PILOT WEATHER REPORTS

This includes the most recent pilot weather reports (PIREPs) of icing, turbulence and sky and weather over the conterminous U.S. using standard symbology. National and regional views are available for each of these three pilot weather report categories.

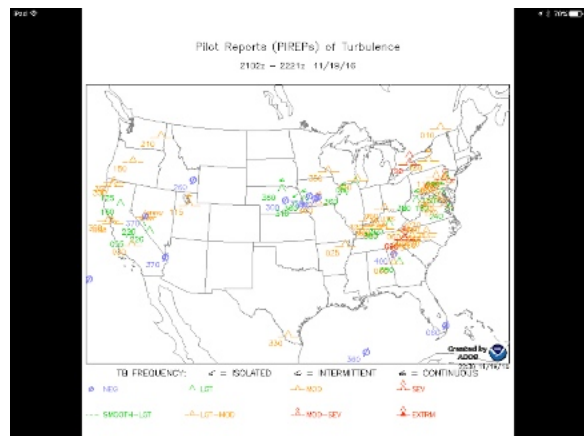

CEILING AND VISIBILITY ANALYSIS

The Ceiling and Visibility Analysis collection provides three graphics depicting current Flight Category, Visibility, and Ceiling information for CONUS and 18 major subdivisions, each named after a city in each region.

Ceiling estimates are displayed as "Possible Terrain Obscuration" (pale orange) for ceilings less than 200 ft AGL, "Less than 1000 ft" (pale yellow) from 200 to 999 ft AGL, and "1000 ft or greater" (pale blue) above 1000 ft AGL. Visibility estimates are displayed as pale yellow for less than 3 miles and pale blue for 3 miles or greater. VFR conditions are shown if the ceiling ≥ 1000 feet **and** the visibility ≥ 3 statute miles (sm), while IFR conditions are shown if the ceiling $< 1,000$ feet **and/or** visibility < 3 statute miles.

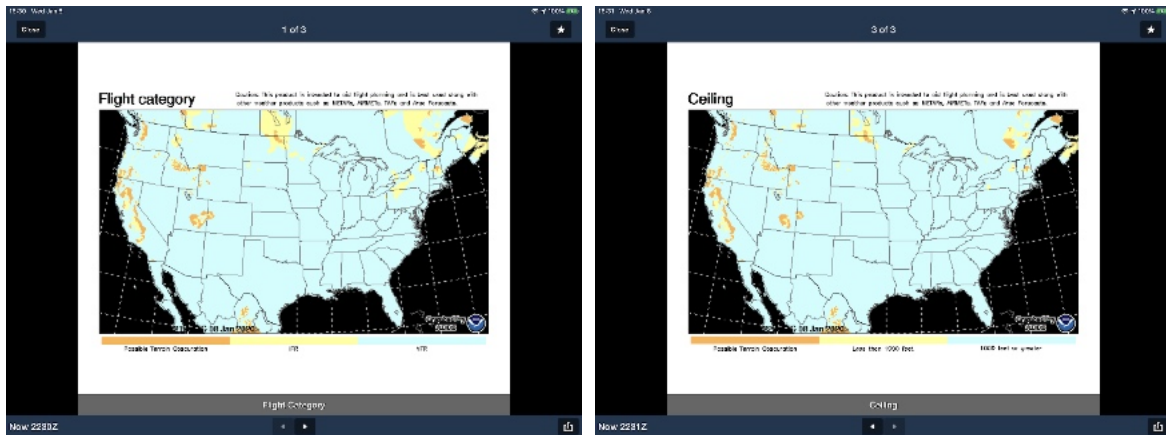

These detailed graphics replace the single "Weather Depiction" chart that was previously available in the National > Featured section.

The regional charts include current weather, ceiling, visibility, and cover observations reported at selected METAR stations.

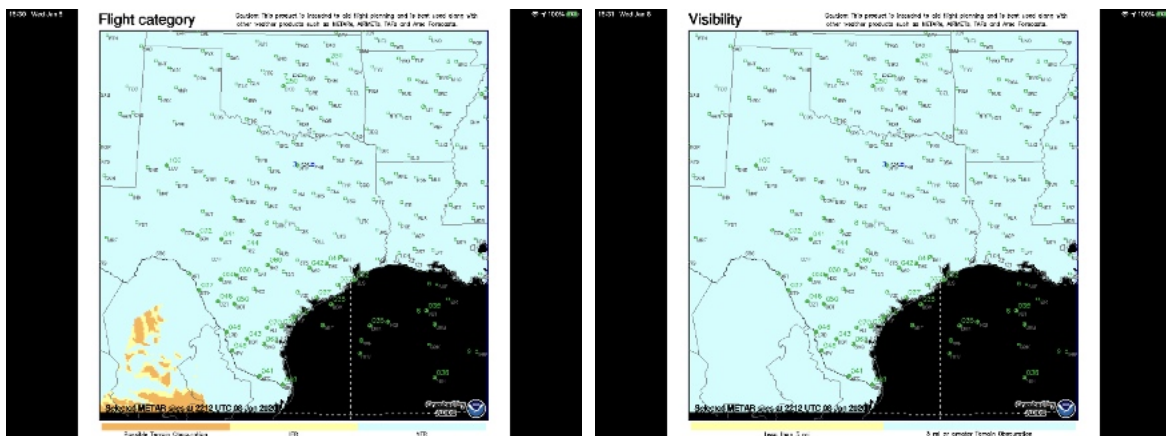

Viewing an Image

View a image full screen by tapping on its thumbnail. View a list of recently-viewed images by tapping the **Favorites/Recents** button  and tapping the Recents tab. The full screen view supports all the standard zoom and pan gestures, as well as rotation.

Dismiss the full screen image by tapping the **Close** button at the top left.

Tap the star at the top right to add the current image as a favorite. 

Using Favorite Images

View all favorite images by tapping the **Favorites/Recents** button  and tapping the Favorites tab.

Tap an image in the list to view it full screen.

The favorites list can be re-ordered by tapping the **Edit** button. Once in Edit mode, a three-bar icon is displayed to the right of each image in the list. Tap-and-hold on the three bar icon until the image row appears to lift up, then drag the row to the desired location in the list.

Delete an image from the favorites list using swipe-to-delete. Or, tap the **Edit** button and then the red circle icon beside the image. Then, tap the **Delete** button.

Send To

Tap the Send To button  in the bottom-right corner while viewing an image to save, email, or copy the image to your device's clipboard. Saving the image adds it to your device's Photos app so you can view it offline.

Flights

About the Design

The Flights view provides a quick way to plan, brief, and file a flight plan. Flight plans can be filed for departures from 10 minutes in the future up to days in advance. The top-to-bottom workflow follows a logical progression from inputting airports, selecting an aircraft and performance profile, defining a route and altitude, then filing the flight plan. Plans created on the Flights page can also be sent to the Maps page for graphical review, and routes can still be sent from the Maps page to Flights to create and file a flight plan, and to get a briefing.

ForeFlight customers who have purchased a Performance Plus or Business Performance subscription can also use high-fidelity aircraft performance profiles to quickly and accurately plan their flights including Takeoff & Landing performance, passengers, baggage, and fuel. For more information about the Performance plans, please visit www.foreflight.com, or see the **Performance Planning in ForeFlight Mobile** guide in the ForeFlight Drive in [Documents](#).

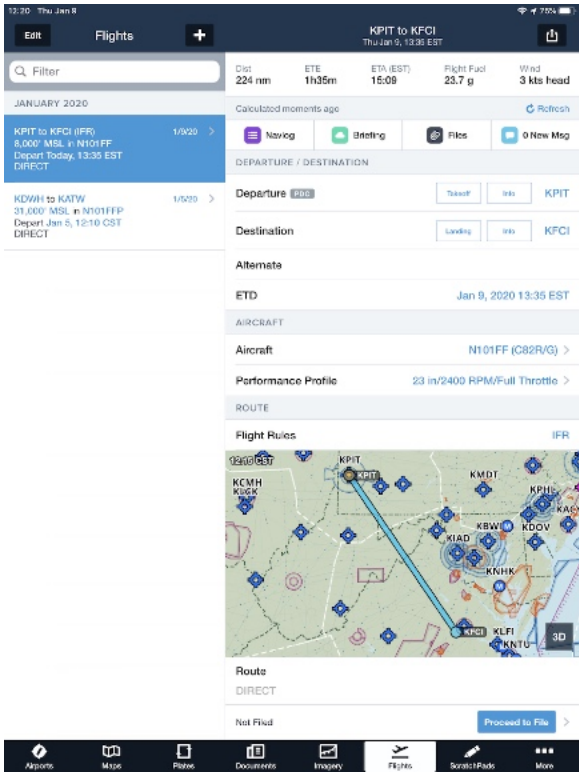

Takeoff and Landing Performance

Integrated Takeoff & Landing Performance calculations are now included at no additional charge in Performance Plus. The calculations incorporate aircraft performance and weather data (live data including from ADS-B or XM, or pilot-updated based on ATIS/AWOS) as well as a pilot-entered safety factor to calculate important flight metrics such as Takeoff Roll, Approach speed, etc..., and help pilots ensure they're within the aircraft's and runway's limits. Available for over 260 popular piston and single-engine turboprop aircraft, with more planned in the future.

The screenshot displays two flight performance screens. The left screen is for KCFD to KLBB, showing flight details like distance (345 nm), ETE (2h25m), and fuel (53 g). The right screen is for KCFD to KMAF, showing runway information (Runway 33, Slope -0.25%, Usable Length 4,000') and weather data (Wind Direction 350°T, Wind Speed 8 kts, Temperature 6°C, Altimeter 30.46 inHg). A 'Safety Distance Factor' dialog box is overlaid on the right screen, showing a value of 1.25. The dialog box has a 'Close' button and a numeric keypad with a backspace key.

For more information, see the **Performance Planning in ForeFlight Mobile** guide in Documents in the ForeFlight Drive, or in the [ForeFlight Support Center](#).

Alternate Advisor

Tap in the Alternate field to open the Alternate Advisor. The Alternate Advisor gives a list of suggested possible alternate airports based a number of criteria such as time and fuel requirements to reach the alternate, forecast weather conditions, available approach procedures, and whether you have previously selected that airport as an alternate on flights with the same destination. Be sure to check Alternate Minimums for the selected airport before filing.

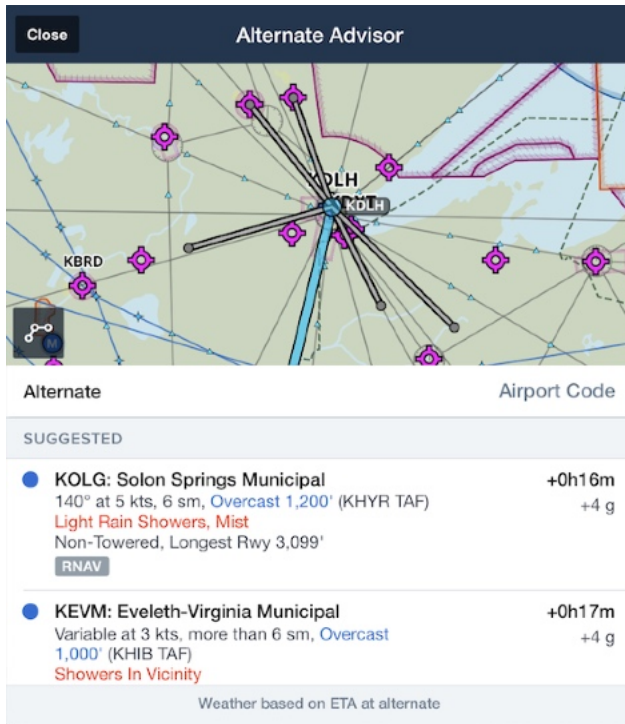

iPad

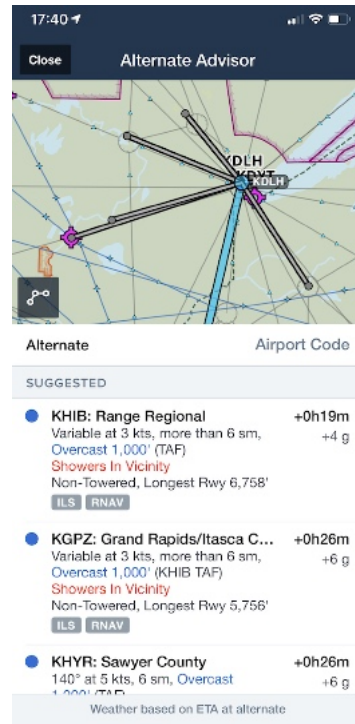

iPhone

To enter an alternate not in the suggested list, simply tap on the “Airport Code” and type your desired airport.

The map view shows each alternate with a grey line between it and the destination. Tap the entry to see the route from your destination to the alternate highlighted in blue on the map, then tap the “Add [ID] as Alternate” button to add that alternate to your Flight.

NOTE: For Performance subscribers, [Takeoff and Landing Performance](#) is not currently calculated for the Alternate airport.

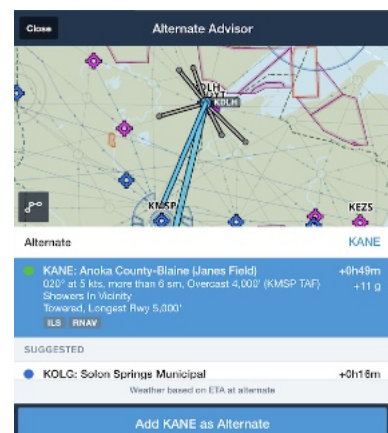

Adding Files to a Flight

If you have ForeFlight Performance Plus or Business Performance you can now attach files, documents, and photos to a flight plan for easy inflight access and improved organization.



Tap the “Files” button at the top of a Flight to attach files from your camera or iPhoto library, iOS Files app, or ForeFlight’s Documents view. You can also import files via AirDrop, drag and drop from apps in Slide Over view, or attach scratchpads from the Scratchpads view. Flights supports images, PDFs, Microsoft Word, Excel, and Powerpoint files, .txt and .csv files, and more.

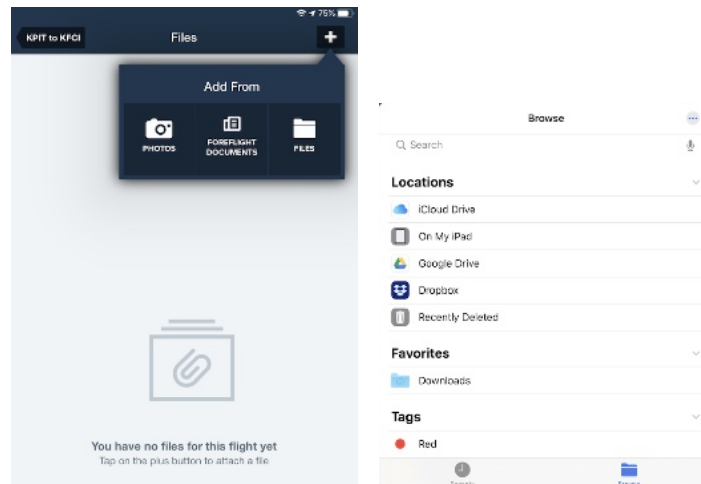

You can annotate attached files while viewing them in Flights, rename an open file by tapping the “Edit” button, or send the file to other apps using the send-to button and iOS share sheet.

Files added to a Flight sync between all of your mobile devices so you can access them from your iPad or iPhone.

Sharing a Flight

Flight Sharing allows you to easily share a read-only copy of planned and filed flights with fellow pilots, co-pilots, or crew members who use ForeFlight Mobile, for improved collaboration and more efficient flight planning. Flight Sharing is available for all ForeFlight subscription plans.

To share a flight, tap the “Send-to” button in the upper right of the Flight, and choose “Share Flight”. You can share flights via AirDrop, email, text message, or any other app that can send messages. Any sharing method other than AirDrop will generate a link that the recipient can tap to load the shared flight onto their device.

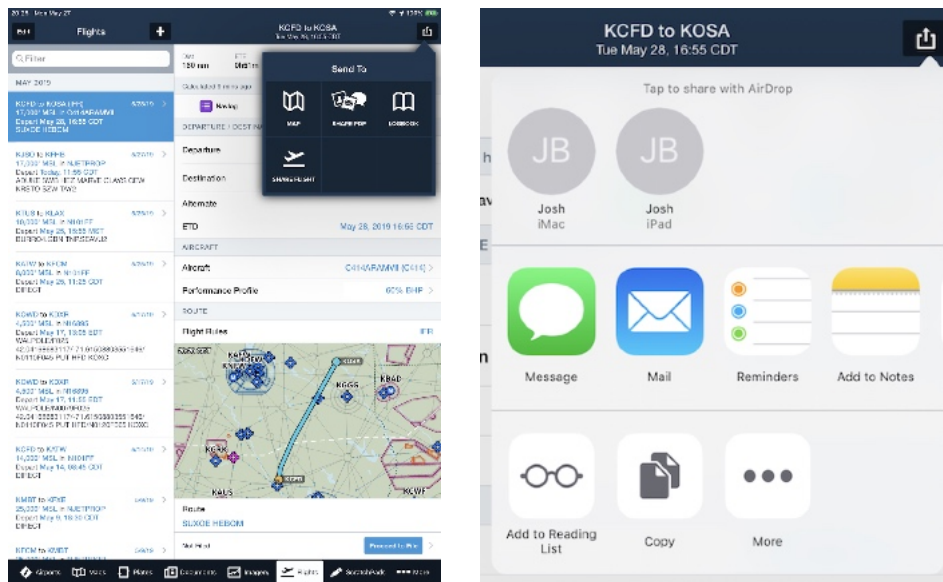

When the recipient Accepts the shared flight, it is added to the Flights list, with a label indicating who shared the flight. Note that the Flight information, including Departure, Destination, Aircraft, Performance Profile, and loading are all in grey text indicating they cannot be edited by the recipient.

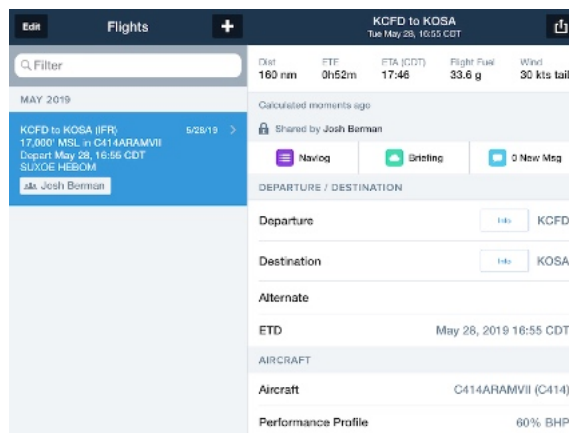

A Shared flight stays connected to the original via ForeFlight's Sync system, so any changes made to the original flight are also reflected on the recipient's shared flight once both devices have an internet connection (changes made while offline are cached and sent once online again). The Flights Navlog, Briefing, and Takeoff & Landing Performance calculations are also tied directly to the original account. So those are not synced until they are viewed by the pilot who shares the flight.

NOTE: if you share a flight from a Performance subscription plan to a recipient who does not have a Performance plan, they will not be able to view the Flights Navlog due to the extra information included on the Navlog with the Performance plan.

A recipient of a Shared flight cannot make changes to the Shared flight or share that flight with someone else. However the recipient can copy the flight. The copied flight preserves all of the Shared flight's details except for the original aircraft and performance profile, which will instead use the recipient's default aircraft and performance profile.

A recipient of a Shared flight can delete the shared flight using the swipe-delete gesture in the Flights list, or by tapping "Delete Flight" at the bottom of the Shared flight. Once deleted by the recipient, the Shared flight cannot be restored by the recipient. However the flight can be shared to the recipient again.

If the pilot who shared a flight tries to delete it, a warning appears advising that deleting the Shared flight will also delete it from all recipients of that shared flight.

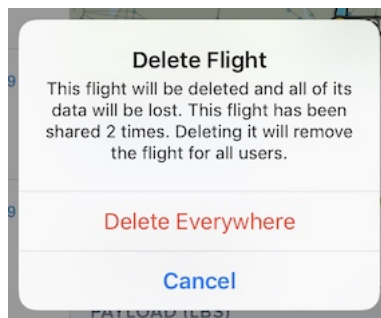

Before Filing a Flight Plan

You can use ForeFlight Mobile to file most VFR and IFR flight plans. ForeFlight recommends selecting the ICAO flight plan type, as that allows us to most efficiently route the plan to the appropriate ATC. ***For flights in the USA, the FAA/Domestic flight plan type was discontinued as of August 27, 2019 so must no longer be used.***

Flight Plan Type	Supported Regions
VFR	<ul style="list-style-type: none"> • Within & between the USA and Canada (U.S. DC SFRA flight plans also supported) • Within & between most EUROCONTROL member states
IFR	<ul style="list-style-type: none"> • Within & between the USA, Canada, Mexico, Caribbean islands, and U.S. territories • Within & between all EUROCONTROL member states and Greenland
Y (IFR to VFR) & Z (VFR to IFR)	<ul style="list-style-type: none"> • Within & between all EUROCONTROL member states and Greenland

You can find a comprehensive list of the countries where we support flight plan filing in [this article](#).

The following actions are available on the Flights page in ForeFlight Mobile when filing an ICAO flight plan:

Action	Flight plan type (ICAO)		
	IFR - Filed	VFR - Filed	VFR - Active
File	ETD	ETD	n/a
Amend	ETD -47 minutes	ETD +2 hours*	Until closed*
Cancel	ETD -47 minutes	ETD +2 hours	n/a
Activate	n/a	ETD +2 hours	n/a
Close	n/a	n/a	Until closed

* ETD cannot be changed. If the ETA needs to be changed, amend the ETE.

IMPORTANT: VFR Flight Plans are only used for Search & Rescue purposes and are **not** sent to Air Traffic Control.

ICAO flight plans in the USA can be filed up to 27 days prior to departure. Future ICAO flight plans filed through ForeFlight are released to ATC approximately 22 hours prior to your ETD.

ICAO IFR, YFR, and ZFR flight plans in Europe can be filed up to 120 hours prior to your ETD.

NOTE: As of October 2014, pilots calling Flight Service to activate a VFR flight plan filed using ForeFlight (as well as other electronic tools) may still be asked for their pilot information, even though that information was transmitted by ForeFlight when the plan was filed. This may be especially prevalent for VFR flight plans filed in Alaska.

Choosing between ICAO and FAA/Domestic Flight Plans

In the US the FAA/Domestic flight plan type was discontinued by the FAA effective August 27, 2019. Therefore the ICAO flight plan should be used for ALL flight plans, both VFR and IFR.

Creating a Flight Plan

Create a flight plan by tapping “Proceed to Filing” after planning a flight as discussed in the [Planning a Flight](#) section of this guide.

You can add a call sign to your flight plan by entering it in the *Call Sign (Optional)* field. When a flight plan is filed under a call sign, the call sign is transmitted to ATC in place of the aircraft’s tail number, and the tail number is copied to the flight plan’s remarks so as to be available to ATC. If no call sign is entered the flight plan will be filed under the aircraft’s tail number.

When *VFR (DC SFRA)* is selected, you need to provide an appropriate gate for SFRA entry as your departure point (when inbound to the SFRA) or the appropriate exit gate in the destination field (when outbound). Your ETE value should match when you expect to enter the SFRA (when inbound) or exit it (when outbound). If you wish to do non-towered airport pattern work within the SFRA enter + *REQ PTTN* in your remarks.

A copy of the flight plan and briefing will be sent to the address in the Email field at the bottom of the filing form. You can enter multiple comma separated email addresses to send flight plan information and updates from ATC like expected route notifications to fellow pilots or crew members.

Creating an ICAO Flight Plan

For details about creating an ICAO flight plan and entering the ICAO-specific aircraft information in **More > Aircraft**, refer to “Filing with ForeFlight” available in the Documents Drive under ForeFlight, or watch this [Video Tutorial](#) (internet connection required).

Exporting an ICAO Flight Plan as PDF

You can create a formatted PDF of your Flight Navlog and official ICAO flight plan form layout by tapping the Send To button at the top-right of the Flight view, then tap “Share PDF”.

You can share the PDF via AirDrop, email, print, or other available options.

To create a PDF of just the flight plan (without the Navlog) tap the “Proceed to File” button, then tap the Send To button at the top-right of the File pop-up.

Tap the “Save to ForeFlight Documents” to save a PDF copy of the flight plan form to the “Imported” Drive in Documents. You can then add the “Flight Plan Form:...” to whichever binder you choose.

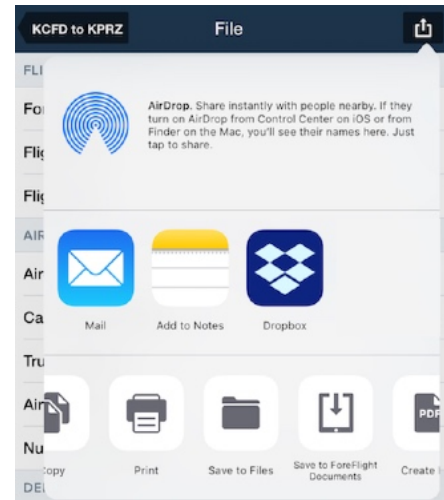

Obtaining a Weather Briefing

The recommend default is to obtain a graphical [ForeFlight Briefing](#) by tapping the “Briefing” button.

Sections of the briefing listed in bold have content for you to review; plain sections are empty. Once you have selected a section, you can use the left and right arrows at the top right to skip to the previous or next section, respectively.

Tapping the top left button (labeled with the origin and destination) takes you back to the briefing section list. Tap **Flights** at the top left to return to the flight plan form.

Briefings are included in ForeFlight’s [Sync](#) system, so any briefing you retrieve on one device or ForeFlight Web will also become available on all your other signed-in internet connected devices.

Existing briefings can be refreshed to show the latest data. Select the desired plan form from the list at the left, tap the **Briefing** button at the top center, then tap the **Refresh** button at the bottom left of the briefing to request an updated briefing.

Briefings can only be obtained or refreshed when an active network connection is available.

Filing your Flight Plan

Once your flight plan form is complete, you can file it by tapping the **Proceed to File** button at the bottom right of the form and confirming the action by pressing the **File** button on the popup. An ForeFlight subscription (not a trial) as well as an internet connection (Wi-Fi or Cellular Data) is required to file a flight plan.

The flight plan will either be accepted and you will be notified of a successful file, or it will be rejected and ForeFlight Mobile will identify the error. If rejected, you can correct the error and re-file.

Once a flight plan has been filed, it will no longer be editable, but it can be Amended. To create a new flight plan form from the filed plan, tap the **Send To** button

 and choose **Copy**.

You can also use the Send To button to transfer your flight plan from the Flights view to your panel avionics by tapping **Panel** in the Send To menu. **NOTE:** Sending a flight plan to your panel will include SIDs and STARs but will not include any approach procedures.

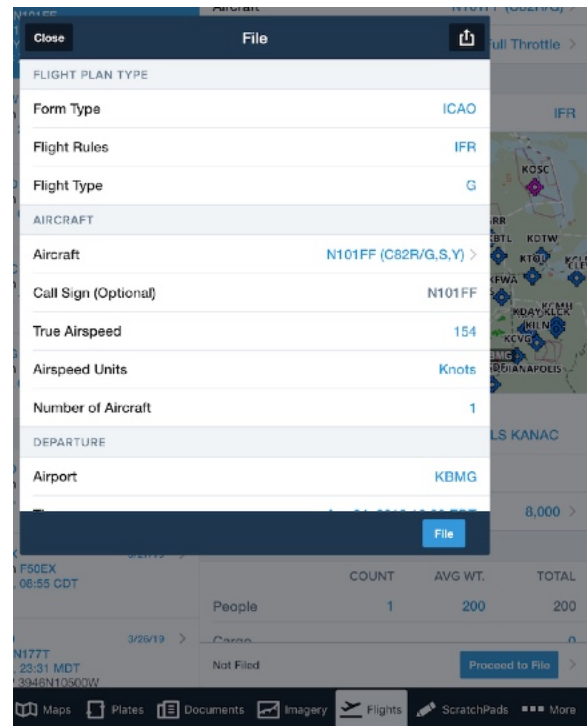

After you have filed your flight plan, tap the > to the right of the “Amend” button to view the details of the plan you filed.

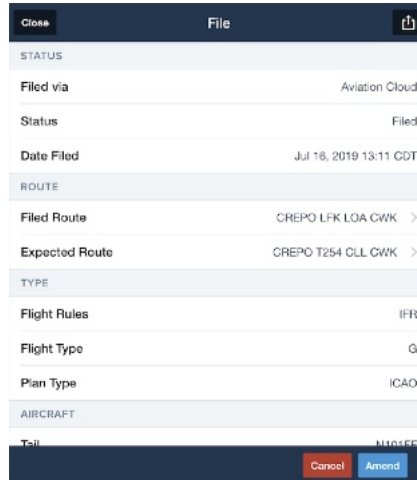

Filing a VFR flight plan in Canada

To better comply with NAV CANADA requirements when filing VFR flight plans in Canada, any flight that includes a Canadian departure or destination shows the **NAV CANADA** section at the bottom of the flight plan form. This section includes fields for specifying your aircraft's undercarriage type, the flight's arrival report, and your aircraft's emergency locator transmitter (ELT) type.

The Arrival Report field indicates where the pilot of a VFR flight will close the flight plan, for example: "London FIC". In addition, the flight plan form now provides "Place Name" fields in the departure and destination sections to help ATC identify either location when you file with lat/long coordinates instead of airport identifiers.

The Aircraft Detail view also includes a new NAV CANADA section with Undercarriage and ELT Type fields, allowing you to independently configure these for each of your aircraft.

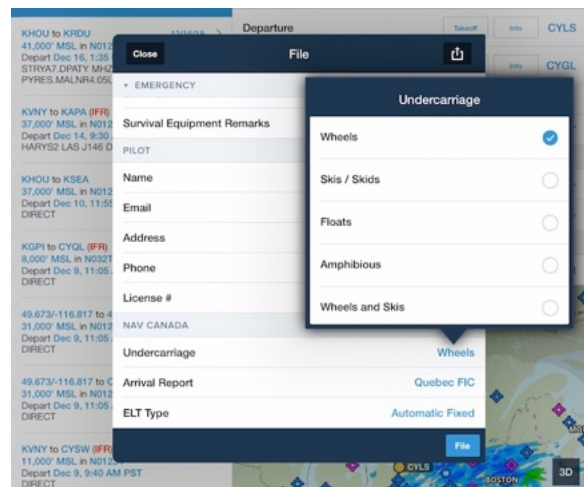

Filing an IFR, Y, or Z Flight Plan in Europe (ICAO ONLY)

Currently ForeFlight supports filing IFR, Y (departing IFR then transitioning to VFR), and Z (departing VFR then transitioning to IFR) ICAO flight plans within and between EUROCONTROL member states and Greenland up to 120 hours prior to ETD. VFR flight plans, and transatlantic flight plans are NOT currently supported.

Albania	Armenia	Austria	Belgium
Bosnia and Herzegovina	Bulgaria	Croatia	Cyprus
Czech Republic	Denmark	Estonia	Finland
France	Georgia	Germany	Greece
Greenland	Hungary	Ireland	Italy
Latvia	Lithuania	Luxembourg	Malta
Moldova	Monaco	Montenegro	Netherlands
Norway	Poland	Portugal	Republic of Macedonia
Romania	Serbia	Slovakia	Slovenia
Spain	Sweden	Switzerland	Turkey
Ukraine	United Kingdom		

NOTE: See this [article](#) for the most up-to-date European filing details. Or visit <https://www.foreflight.com/support/support-center> and search for “Will ForeFlight work in my country”

Flight Plan Acknowledgment Notification

After you file your flight plan you should receive two notifications by email and push notification directly to your device. First that device will receive a “Filing Succeeded” message, indicating that the plan was successfully filed.

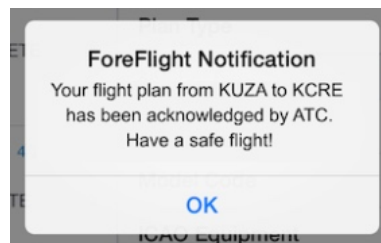
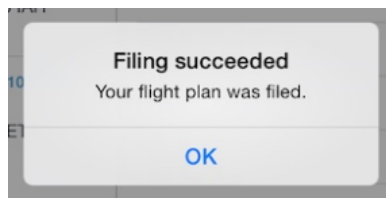

After filing, your flight plan is transmitted to ATC at ETD -3 hours (or immediately if your ETD is within 3 hours). Once ATC acknowledges receipt of the plan, that device will receive a “ForeFlight Notification.”

Under certain circumstances ForeFlight may not receive the ATC notification; in that case, the device that filed the plan will receive a message, “ForeFlight has not yet received a notification from Flight Services indicating that ATC has acknowledged your upcoming flight from KXXX to KZZZ (N9999).”

Flight Notifications

After filing your flight plan, two hours prior to your scheduled departure time ForeFlight will begin monitoring your route of flight and providing weather and other alerts relevant to your filed flight plans. You must have an active internet connection to receive these alerts and [Sync](#) must be enabled for your account.

ForeFlight notifies you if there are updates to: TFRs, airport/runway closed/unsafe NOTAMs, urgent PIREPs, SIGMETs, Convective SIGMETs, AIRMETS, Center Weather Advisories (CWAs), and Severe Weather Watches/Warnings that affect your filed route.

ForeFlight will notify you of any new conditions affecting a file plan via a red badge (showing the number of Notifications) on the Flights tab, and via text on the Flight plan listing on the left side of the Flights page.

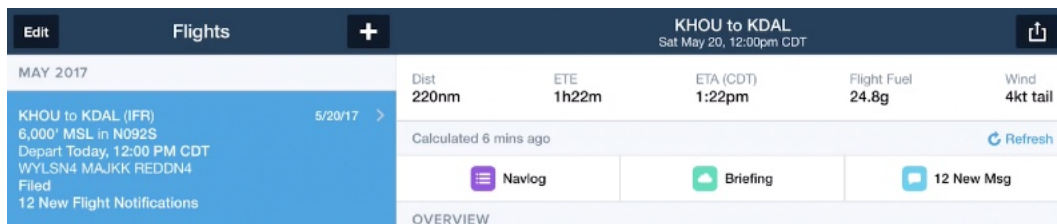

Select the Flight Plan in the left column, then tap the “# New Msg” button at the top of the flight plan to view a summary of the alerts. A thumbnail of each alert’s graphic is shown to the left of the alert.

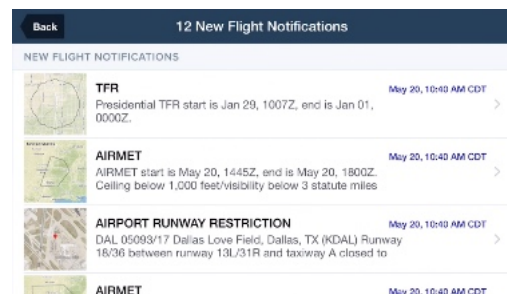

Tap an individual alert to view all details, including the full-size graphic. Tap the “Next” or “Prev” button to move through the list.

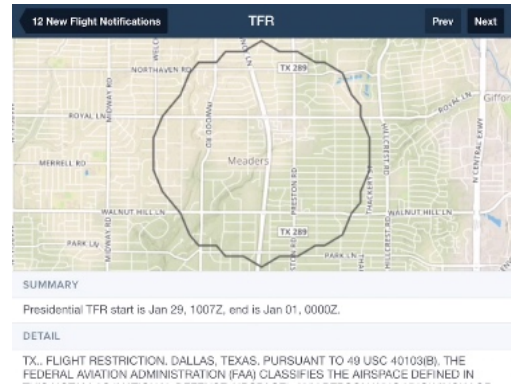

Amending or Canceling a Flight Plan

The guidelines around amending or canceling an IFR flight plan vary depending on the country where you are filing. **Please read below for country-specific information.**

In the USA

IFR flight plans should be able to be amended or canceled up to 47 minutes before the filed departure time. Within 47 minutes of the filed departure time, the "Amend" and "Cancel" buttons are no longer displayed. If you need to make a change less than 47 minutes before your filed departure time, contact ATC directly via phone or radio.

If you are departing PRIOR to your filed departure time, your filed IFR plan should be available within 22 hours before that filed departure time and you can call for clearance using your normal process.

If you are departing AFTER your filed departure time, your filed IFR plan should be available up to 2 hours after your filed departure time and you can call for clearance using your normal process.

VFR flight plans can be amended anytime prior to the filed ETD and can be amended or cancelled up to 1 hour after the filed ETD.

In Canada

If you need to amend an IFR flight plan in Canada, for best results we **strongly recommend** cancelling the existing plan and filing a new plan including the amendments.

If you must amend an IFR flight plan in Canada, amendments can be made between 45-60 min. before the filed departure time, depending on where in Canada you are departing.

NOTE: When filing back to back flight plans allow for **at least 30 minutes** on the ground (eg: the departure time for the 2nd flight plan must be at least 30 minutes **after** the arrival of the 1st plan) otherwise NAVCANADA will treat the 2nd flight plan as an overlapping flight plan and reject it.

Amending a Filed Flight Plan

To amend a filed a flight plan, go to the Flights page, locate the filed flight plan you wish to amend in the column on the left, and tap it to display its information on the right side of the page.

IMPORTANT: DO NOT TAP “AMEND” UNTIL YOU HAVE COMPLETED THE STEPS BELOW

When the Flight is displayed on the right side, make your desired changes, such as changes to the Route, ETD, or any other fields.

In this example, the filed route was: CREPO T254 CLL CWK, but it is being changed to: CREPO LFK LOA CWK.

Once you have completed **ALL** of the changes you wish to make, **only then** should you tap the “Amend” button at the bottom of the Flights page.

After you tap “Amend” a File pop-up will open. Tap “Copy” to copy the changes you made on the Flights tab to the File pop-up.

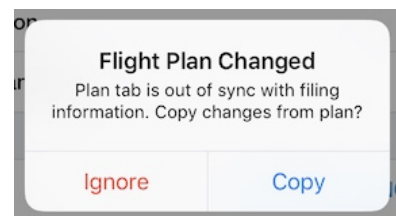
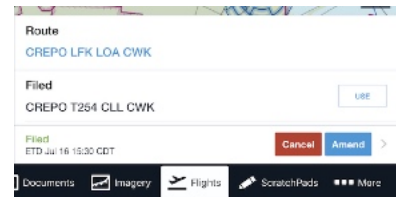
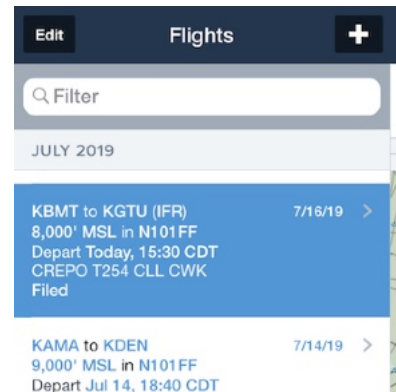

After double-checking that all the fields are correct, tap “File Changes” to file the amended plan.

AIRCRAFT	
Call Sign (Optional)	N101FF
True Airspeed	155
Airspeed Units	Knots
Number of Aircraft	1

DEPARTURE	
Airport	KBMT
Time	Jul 16, 2018 15:30 CDT
Souls aboard	1

ENROUTE	
CREPO LFK LOA CWK	

Or, tap “Close” then “Discard Changes” if you do not want to make changes to the plan.

To cancel a plan, tap the red “Cancel” button.



Activating or Closing a VFR Flight Plan

Once you have filed a VFR flight plan with Leidos and you are ready to depart, tap the “Activate” button on the Flights page to view the confirmation dialog. This lets you know the departure time that will be logged with Flight Services, as well as your ETA based on your ETE and the activation time.

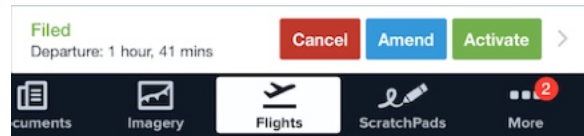

To activate the flight plan directly with Leidos, which is equivalent to calling Flight Service to activate a VFR plan, tap “Yes.”

VFR flight plans must be activated within 2 hours of the filed ETD. If it is more than 2 hours after the filed ETD, you must re-file the flight plan with a revised ETD.

After your VFR plan is activated, the “Close” button will be displayed for that plan. Active VFR plans can only be closed in ForeFlight Mobile if 1) the plan was Filed **and** Activated using ForeFlight Mobile, and 2) your device is connected to the Internet.

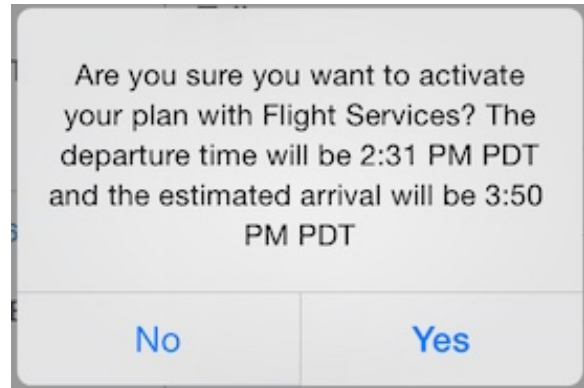

Important note for Canadian VFR Flight Plans

When a VFR Flight Plan is filed in Canada, ATC assumes that you will depart “as filed” ***even if you do not activate the Flight Plan.*** If you decide not to fly but do not call NAVCANADA to cancel your plan, after your ETA they will assume you are overdue and will initiate Search & Rescue activities to locate your plane.

Therefore if your plans change (ETD, or you decide to cancel your flight) **YOU MUST CONTACT NAVCANADA VIA PHONE TO CANCEL YOUR FLIGHT PLAN.**

VFR FLIGHT PLANS IMPORTANT INFORMATION:

ForeFlight will **never** activate or close a VFR flight plan for you. If you have not personally activated a flight plan **and received an acknowledgement** either in ForeFlight or by calling Flight Service then your flight plan will not be activated and SAR services will not be available for your flight. If you activated a VFR flight plan by calling Flight Service then you **must** call Flight Service to close the plan; you **cannot** close a flight plan in ForeFlight that was not activated in ForeFlight.

Activating or closing a VFR flight plan in ForeFlight requires an active internet connection, either over Wi-Fi or cellular. If you are connected to a Sentry or other inflight Wi-Fi device, **you will not have internet connectivity in ForeFlight**, even if you also have a good cellular connection. Although the Activate and Close buttons appear when you are connected to an inflight Wi-Fi device like Sentry, **they will not work because there is no internet connectivity**. You **must** turn off your device's Wi-Fi (or disconnect from the inflight Wi-Fi device) to activate or close a flight plan - swiping up from the bottom of the screen to access your device's Control Center is the easiest way to do this.

If you have filed and activated a cross-border VFR flight plan (e.g. from the U.S to Canada) you **must** close the flight plan directly by calling the destination country's flight service (NavCanada in Canada, FSS in the U.S.), **not** by closing the flight plan in ForeFlight. **Failure to close the flight plan with the destination country may result in Search and Rescue being initiated.**

An easy way to determine the status of your flight plan if using ForeFlight to activate and close (**not** if calling Flight Service) is to look at the bar at the bottom of the Flights view. The flight plan's status appears on the left.

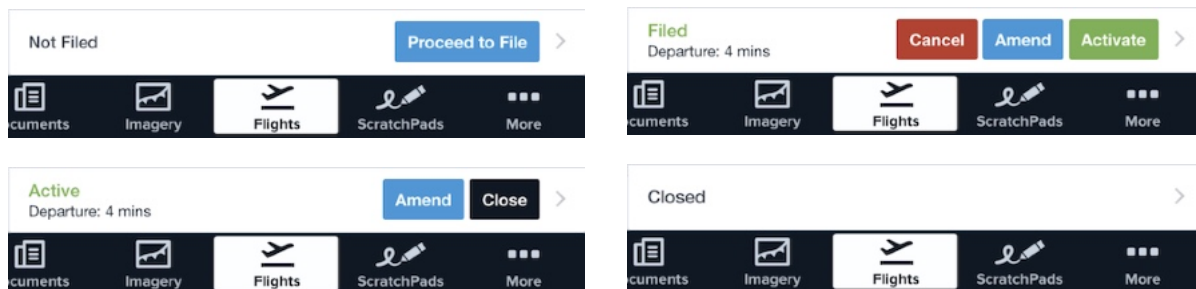

Close VFR Flight Plan “PUSH” Alerts

If you activated a VFR flight plan using ForeFlight Mobile and have not closed the plan 20 minutes after your calculated ETA (Departure time + ETE), ForeFlight will send a “push” notification to your devices reminding you to close your flight plan. You can close the plan using the “Close” button on the Flights page, or by calling 1-800-WX-BRIEF. And if you entered a cellphone number on the flight plan form, you will also receive a SMS notification.

If the plan still has not been closed 30 minutes after your calculated ETA (Departure time + ETA) Leidos will send ForeFlight an “OVERDUE” status update, and ForeFlight will then send another “push” notification (and SMS) to your devices reminding you to close your flight plan immediately.

Managing Flight Plans

When viewing the listing of flight plan, you may wish to remove some to keep the length of the list under control. To remove a flight plan, swipe your finger from right to left across the entry, then tap the red “Delete” button. You can also tap the red “Delete” button at the bottom of an entry and confirm to delete it. This will not close or cancel a filed plan, but will remove its details from ForeFlight Mobile.

Flight Alerts - Expected Routes

Flight Alerts notify you when ATC issues an initial expected route for an IFR flight plan filed using ForeFlight Mobile.

IMPORTANT: The expected route **IS NOT A CLEARANCE** and ATC can and often does change the expected routing at any time after the initial expected route has been issued, based on their traffic flow and coordination needs. ForeFlight **does not receive updates of any changes to an already-issued expected route.**

When the initial expected route information becomes available from ATC, ForeFlight’s servers send a notification of that route information directly to your devices, as well as sending an email with the route information. ForeFlight also sends you a message if our servers do not receive an expected route for your flight from ATC.

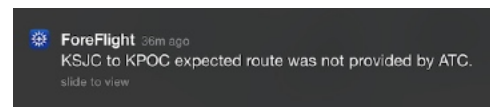

NOTE: if you are a member of a multi-pilot account, the notification is sent only to the device that filed the flight plan.

Swipe Down to display

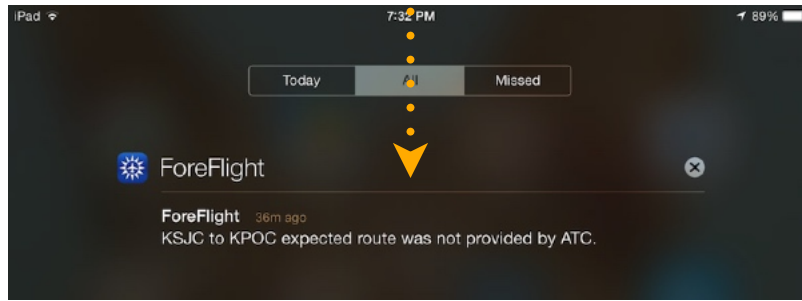

You can also view Expected Route Flight Alerts in the iOS Notification Center, which is accessed by swiping down from very top of the screen with a single finger.

When you tap on the notification or the link in the email, a popup containing the expected route appears on the screen. Tap **Yes** to load the route into the Route Editor. When the expected route is loaded, the flight plan form (on Flights) is updated with the expected route. If you choose to ignore the expected route your originally filed flight plan will remain in the Route Editor.

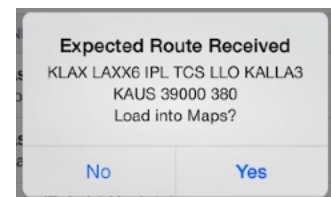

After filing you can also see the Filed and Expected routes on the Flights view. Tap the "Use" button next to whichever route you want to load into the Flight.

At this point, you can wait until you receive your clearance from ATC.

If the clearance matches the Expected Route then you are finished since the expected route is already loaded.

If the clearance is your originally filed flight plan, tap the Use button next to the Filed route, this will reload the original route into your flight plan.

If the clearance is other than the Expected Route or the original route, you need to manually edit the route in ForeFlight.

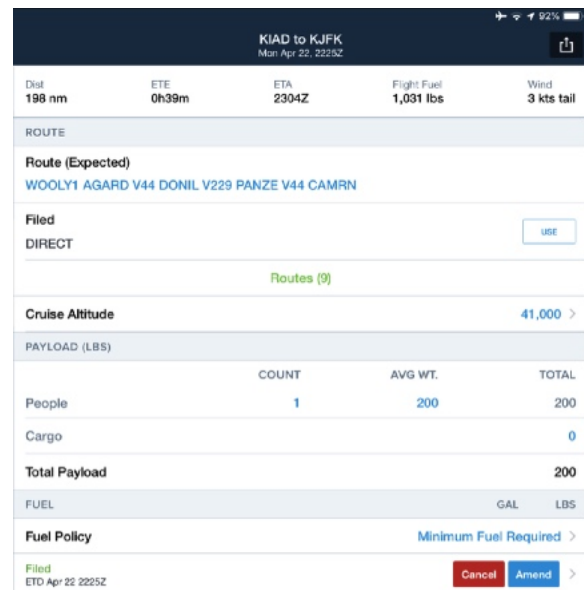

IMPORTANT: If the Expected Route you receive is different than your filed route, ForeFlight recommends that you do not cancel and re-file with the Expected Route in order to try to receive a "Cleared as Filed". The Expected Route is issued by a national level system and does not take into

account local conditions that may require that Clearance Delivery or Departure make further changes to your route.

NOTE: ForeFlight cannot parse Expected Routes that do not originate at a Fix (e.g., "Radar Vectors to V17..."). If your Expected Route doesn't originate at a Fix, ForeFlight plots a route "direct-to" the next Fix on the route. The "direct-to" route may differ significantly from the instructions you will be given by ATC. **After loading an Expected Route, verify that all legs are displayed correctly and be prepared to follow ATC instructions for legs not originating at a Fix** (e.g., "Radar Vectors to V17...")

Flight Log

The Flight Log allows pilots to quickly record fuel remaining at shutdown, as well as flight meter (aka: Hobbs, or tach) times, as well as Times Out, Off, On, and In times.

FLIGHT LOG			
Fuel at Shutdown (g)			11
Times	FLIGHT	BLOCK	METER >
	3.0	3.2	3.3 >

The Flight Log is shown on the Flight view and is included in all plan levels. The Flight time (the difference between Off and On), Block time (the difference between Out and In), and Meter times (the difference between Start and End) are all calculated automatically once values have been entered.

Times can be entered a Zulu (Z) time, or in local times. Note: Flight Log times are not synchronized with Logbook.

The screenshot displays the 'FLIGHT LOG' section of the application. It shows a 'Fuel at Shutdown (g)' field with the value '11' and a 'Times' section with columns for 'FLIGHT', 'BLOCK', and 'METER', each with a value (3.0, 3.2, 3.3) and a chevron. Overlaid on this is a 'Time Out' dialog box for 'KEDC' showing a calendar with 'Today 09 18' selected. Another dialog box for 'Fuel at Shutdown (g)' is open, showing a numeric keypad with digits 1-9, 0, and a delete key.

Tap "Clear Time" to remove a time from an entry. Note: If both times required to calculate a value have not been entered, the time will show as "Logged"

Times	Logged >
-------	----------

ForeFlight Briefing

About the Design

ForeFlight Briefing provides a graphical and translated weather briefing in place of the older wall-of-text briefing. The information it presents is the same as the text briefing and comes from the same source (Leidos), but the layout and navigation have been overhauled to improve readability and ease of comprehension. You can enable or disable ForeFlight Briefing in More > Settings > File & Brief.

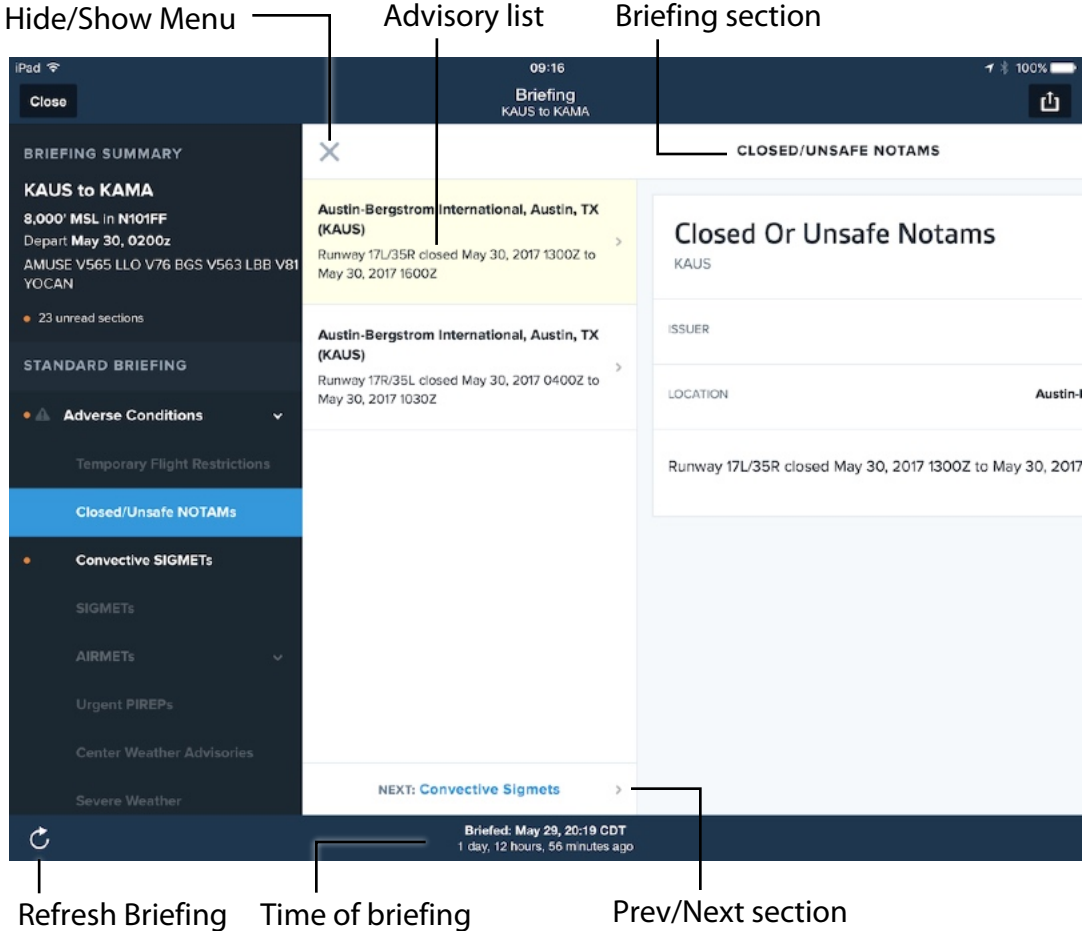

ForeFlight Briefings are included in ForeFlight's [Sync](#) system, so any briefing you retrieve on one device or ForeFlight Web will also become available on all your other signed-in internet connected devices. You can tap on any graphic in the Briefing to view it in full screen, and double-tap or pinch to zoom.

Navigating the Briefing

ForeFlight Briefing is organized into sections that can be accessed by tapping the Menu button in the upper-left corner of the screen, or by swiping right. This opens a sidebar with a summary of the briefing at the top, followed by the list of sections. Sections with a carat next to them contain subsections which can be accessed by tapping the section to expand it. Tapping on a section with no subsections will take you to that page of the briefing. Orange dots indicate that a section (or one of its subsections) has not been viewed. Swipe left or tap the “X” button next to the sidebar to hide the menu.

At the bottom or bottom left of each page is the “Next” button, which shows what the next page in the briefing is. Tap it to move to the next page, or tap the smaller “Back” button to its left to move back one page.

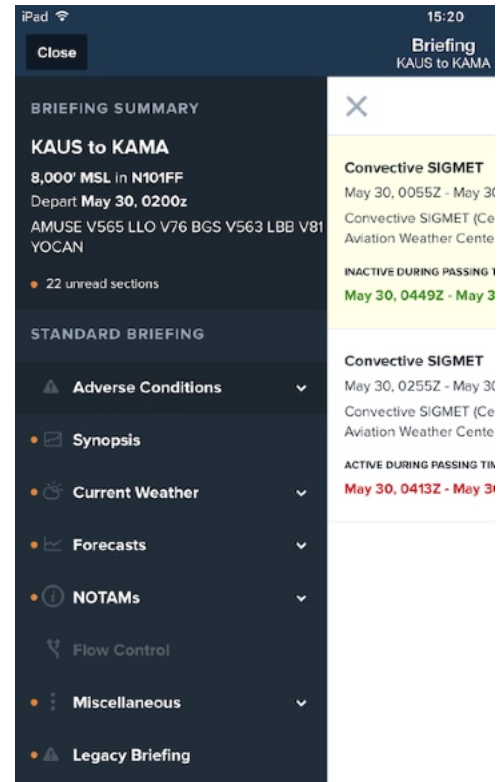

Translated Text vs Raw Text

Most pages in the briefing allow you to view both the raw text of the briefing and the translation of that text. On split-screen pages like those in the Adverse Conditions section or the Synopsis page, you can view the raw text by tapping “Show Raw Text” at the bottom of the right column. On full-screen pages like the METARs, TAFs, or NOTAMs pages, a “Plain Text” slider at the top right of the page allows you to toggle the text between raw and translated. The position of this slider is retained between pages in the same briefing.

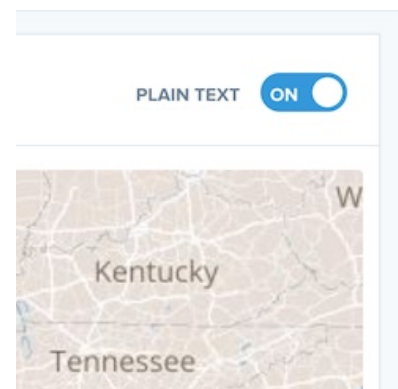
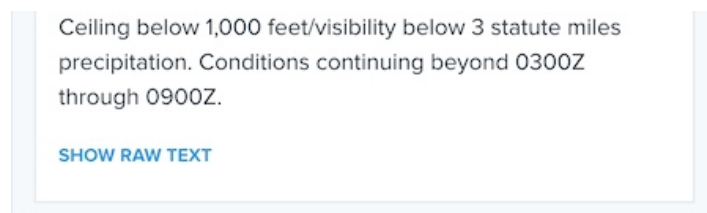

Briefing Sections

Adverse Conditions

The Adverse Conditions section includes important safety advisories such as TFRs, closed/unsafe NOTAMs, and AIRMETs and SIGMETs.

These pages are laid out in a split-screen view: on the left is a list of selectable advisories with basic information about each, and on the right is more detailed information about the selected advisory, including the translated text and a map showing the advisory against your route of flight.

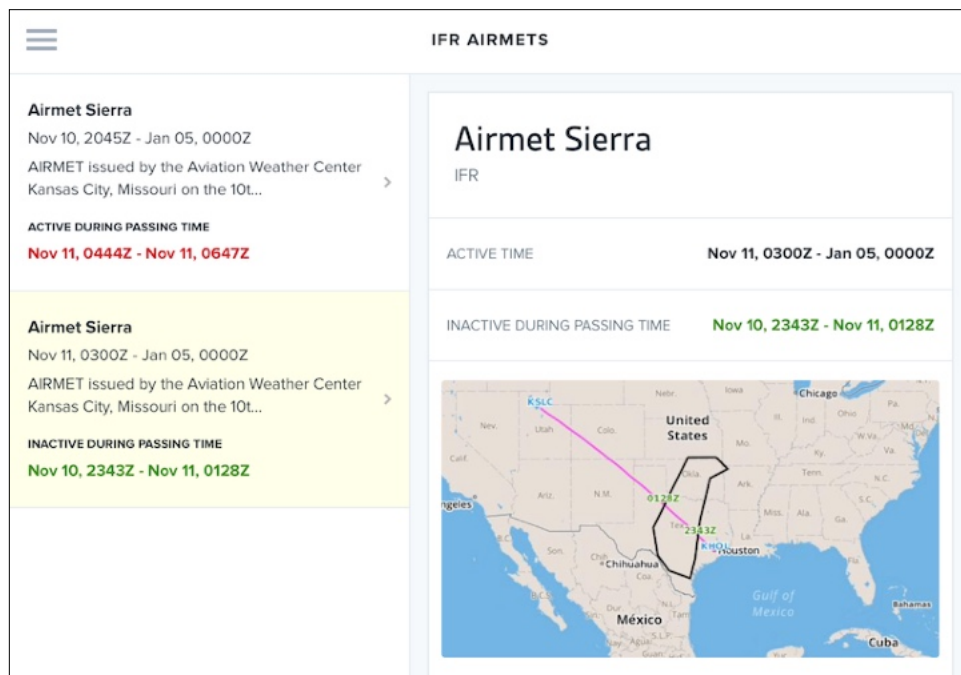

The time at which the advisory is active is shown at the top, and below that is the time interval during which you will pass the advisory. This interval is color-coded based on how close your passing time is to the time at which the advisory is active: **Green** means the advisory won't be active during or near your passing time, **Orange** means the advisory will be active near your passing time, and **Red** means the advisory will be active during your passing time.

Synopsis

The Synopsis page provides an overview of the weather trends for each geographical area through which your route passes. As with the Adverse Conditions section, you can select each area's forecast from a list on the left, and read the translated text of that forecast on the right. At the top of the left column is the most recent Surface Analysis Chart for the Continental US published by the National Weather Service.

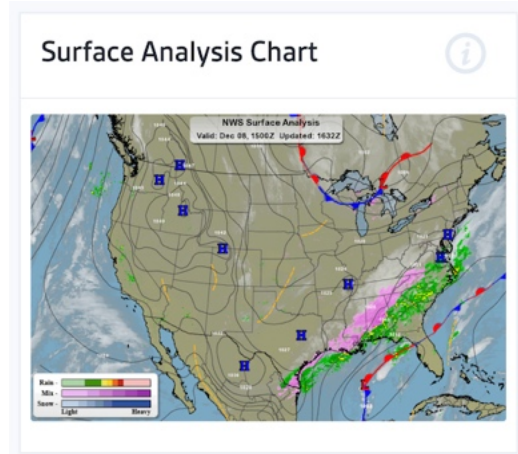

Current Weather

The Current Weather section includes information on current conditions along your route.

The METARs page shows the most recent METARs issued for the airports along your route. At the top of the page is a map showing your route and colored bubbles indicating the flight category at each airport. The [coloring system](#) for the bubbles is the same as what is used in the Flight Category layer on the Maps view.

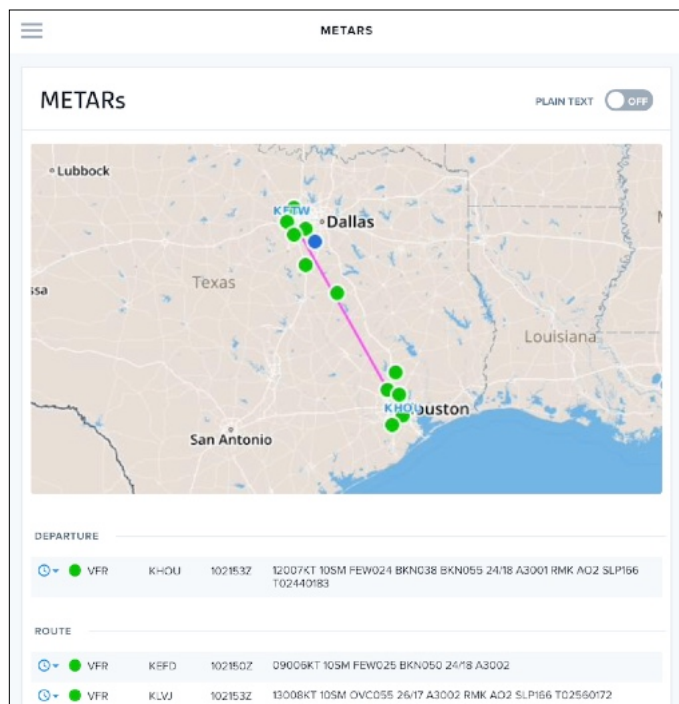

Forecasts

The Forecasts section includes information on forecasted conditions along your route.

The Cloud Coverage and Vis, Sfc Winds & Precip sections provide graphics showing forecasted cloud coverage and forecasted visibility, surface winds, and precipitation, respectively. Graphics are provided for every region within the

continental United States that your route passes through, for all times that your flight is active.

The TAFs page displays TAFs for every airport that issues them along your route. Like the METARs page, it includes a map at the top showing your route and flight categories that correspond to the TAFs that will be valid for each airport during your passing time.

2331Z	VFR	Easterwood Field, College Station, TX (KCLL). Issued Nov 10, 1726Z, valid from Nov 10, 1800Z until Nov 11, 1800Z. Wind from 160° at 9 knots, greater than 6 statute miles visibility, Scattered Clouds at 3,000 feet, Ceiling is Broken at 5,000 feet
+29min →	VFR	From Nov 11, 0000Z, Wind from 150° at 6 knots, greater than 6 statute miles visibility, Scattered Clouds at 2,500 feet, Ceiling is Broken at 4,000 feet
	MVFR	Temporary between Nov 11, 0200Z and Nov 11, 0600Z, Ceiling is Broken at 1,500 feet, Broken Clouds at 3,000 feet
	MVFR	From Nov 11, 0600Z, Wind from 160° at 9 knots, greater than 6 statute miles visibility, Ceiling is Broken at 1,500 feet, Broken Clouds at 3,000 feet, wind shear surface to 2,000 feet, wind from 230° at 35 knots
	MVFR	From Nov 11, 1500Z, Wind from 180° at 10 knots, greater than 6 statute miles visibility, Showers in the Vicinity, Scattered Clouds at 700 feet, Ceiling is Broken at 1,500 feet.
	VFR	San Luis Valley Rgnl/Bergman F, Alamosa, CO (KALS). Issued Nov 10, 1727Z, valid from Nov 10, 1800Z until Nov 11, 1800Z, Wind from 180° at 12 knots, greater than 6 statute miles visibility, Sky Clear
	VFR	From Nov 10, 2000Z, Wind from 210° at 15 knots with gusts to 25 knots, greater than 6 statute miles visibility, Few clouds at 10,000 feet
0411Z	VFR	From Nov 11, 0200Z, Wind from 230° at 15 knots with gusts to 25 knots, greater than 6 statute miles visibility, Showers in the Vicinity, Scattered Clouds at 3,000 feet, Ceiling is Broken at 6,000 feet
	VFR	From Nov 11, 1000Z, Wind from 280° at 12 knots with gusts to 22 knots, greater than 6 statute miles visibility, Ceiling is Broken at 8,000 feet
	VFR	From Nov 11, 1600Z, Wind from 340° at 12 knots, greater than 6 statute miles visibility, Scattered Clouds at 12,000 feet.

Below the map is a list of TAFs that will be valid at or near the time you pass each airport. Highlighted TAFs will be valid at the time of your passing, which is shown in a box on the left. If a TAF will be valid within an hour of your passing, but not during your passing, the time difference between when that TAF is valid and your time of passing is shown on the left, with an arrow pointing at the TAF. These numbers can be positive or negative. For example, if a new TAF becomes valid 29 minutes after I pass an airport, that time difference is shown next to the TAF, as in the screenshot above. This feature is meant to let you know when weather might take a turn for the worse near your passing time.

The Winds Aloft section compares forecasted winds aloft at your filed altitude with winds aloft at other altitudes. Enable the switch in the top-right of the page to limit the altitudes shown to only those within 4,000' of your filed altitude; disable it to show winds aloft forecasts for all altitudes.

Winds Aloft ONLY ALTITUDES WITHIN 4,000FT

VALID: December 08, 1800Z FOR USE: 1400Z - 2100Z 6hr

Station ID	35000 -4000 FT	37000 -2000 FT	39000 FILED	41000 +2000 FT	43000 +4000 FT
HOU	230° 112kts -47°C	230° 101kts -48°C	230° 91kts -50°C	233° 91kts -52°C	236° 92kts -5
DLH	338° 72kts -49°C	334° 61kts -48°C	330° 50kts -47°C	N/A	N/A
PSX	240° 115kts -47°C	240° 104kts -48°C	240° 94kts -50°C	N/A	N/A
CLL	240° 78kts -46°C	240° 72kts -47°C	240° 66kts -49°C	N/A	N/A
SHV	230° 84kts -47°C	230° 80kts -48°C	230° 76kts -49°C	230° 78kts -50°C	230° 80kts -5
LIT	228° 76kts -46°C	224° 77kts -47°C	220° 79kts -49°C	226° 79kts -51°C	233° 80kts -5
FSM	264° 23kts -47°C	252° 29kts -48°C	240° 36kts -49°C	N/A	N/A
SGF	274° 24kts -46°C	262° 29kts -47°C	250° 35kts -48°C	250° 36kts -50°C	250° 37kts -5
COU	260° 32kts -46°C	260° 33kts -47°C	260° 35kts -49°C	N/A	N/A
MKC	342° 36kts -50°C	326° 32kts -50°C	310° 28kts -51°C	296° 29kts -52°C	283° 31kts -5
BRL	268° 36kts -47°C	264° 38kts -48°C	260° 40kts -49°C	N/A	N/A
DSM	350° 53kts -51°C	330° 48kts -50°C	310° 43kts -50°C	310° 38kts -50°C	310° 33kts -5

The page contains three tables providing 6-, 12-, and 24-hour winds aloft forecasts. Each column provides wind forecasts

for different altitudes, and each row shows the forecasted winds at each waypoint in your route. If the switch in the top-right of the page is disabled, you can swipe left and right on each table to view forecasted winds at altitudes that are more than 4,000' from your filed altitude.

NOTAMs

The NOTAMs section includes all the NOTAMs for your flight, apart from the closed/unsafe NOTAMs, which are found in the Adverse Conditions section.

Nearly all of these pages have the same layout, with a map showing your route at the top and the NOTAMs below. The only exception is the Enroute Obstruction NOTAMs page, which has a table at the top showing the total number of obstructions along your route, and how many of them are within 500 feet, 1000 feet, or beyond 1000 feet of your filed altitude, and how many have an unknown MSL altitude.

Miscellaneous

The Miscellaneous section includes any NHC bulletins that have been issued, as well as a page showing three days of convective outlooks issued by the Storm Prediction Center.

ScratchPads

About the Design

ScratchPad lets you choose from six different Scratch Pad templates to quickly record useful information. Any changes you make to a ScratchPad are automatically Sync'd to any other iPads signed-in to your account (ScratchPads are not currently available on the iPhone). Tap the "+" button (upper-right) or "+ NEW SCRATCHPAD" rectangle to open the ScratchPad template chooser, or tap an existing ScratchPad thumbnail to open it.

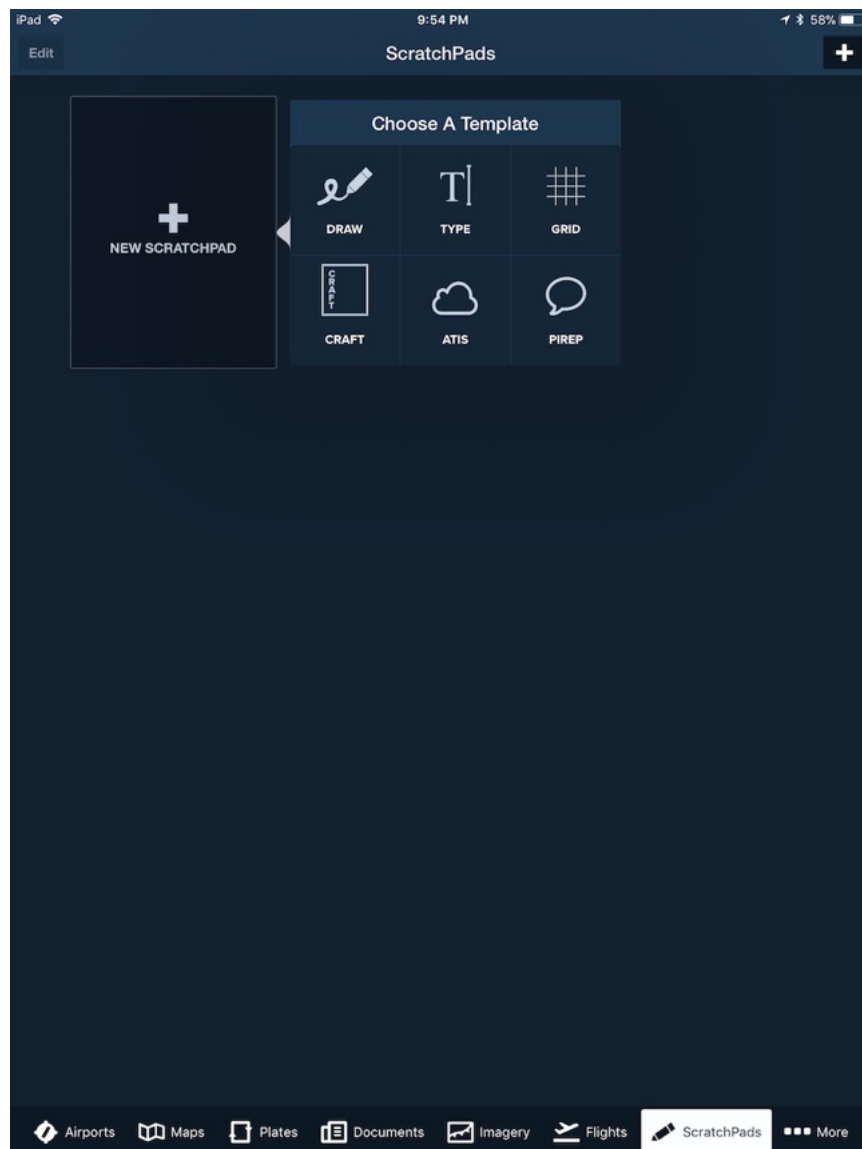

ScratchPad Templates

When creating a new ScratchPad page, there are six templates to choose from:

DRAW: Freehand drawing using the selected Pen type & color.

TYPE: Text ScratchPad for typing using the on-screen keyboard.

GRID: Freehand drawing with underlying grid.

CRAFT: For IFR pilots: Cleared-to, Route, Altitude, Frequency, Transponder.

ATIS: Fields for ATIS information using freehand drawing.

PIREP: Fields for required and optional PIREP information using freehand drawing.

Change Pen Size, Color, Opacity

Tap the **Pen Settings** button at the top-left to change the size of the pen used for drawing on the ScratchPad. Choose the Color, Opacity and Thickness as desired.

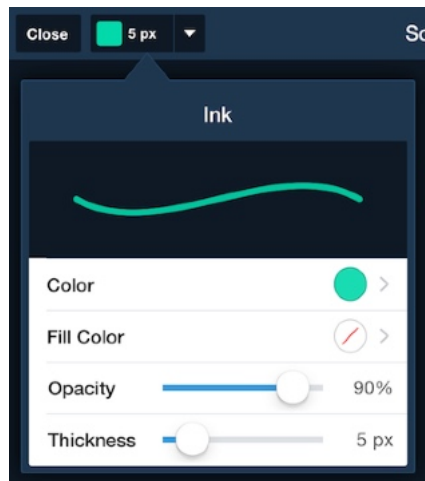

IMPORTANT: Leave Fill Color as transparent (white background with a red slash)

Undo/Redo/Eraser

While editing a Scratchpad, tap the Undo button one or more times to undo recent changes. Tap the Redo button one or more time to redo changes that were recently undone. If you have drawn on a Scratchpad you can also tap the Eraser button then touch and move your finger over any mistakes you want to erase.

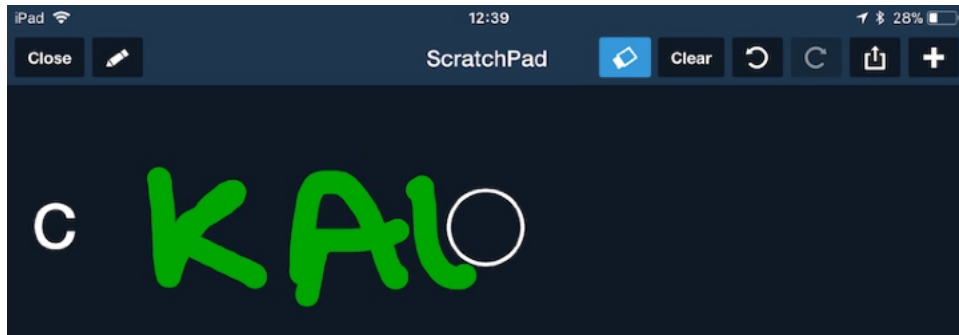

Clear ScratchPad Content

When viewing a ScratchPad, tap the **Clear** button near the top-right to clear all information you have entered on the ScratchPad. A confirmation window will appear to confirm that you really want to clear everything.

Edit a ScratchPad Name

The default name for a ScratchPad is the date and time that the ScratchPad was created or last edited.

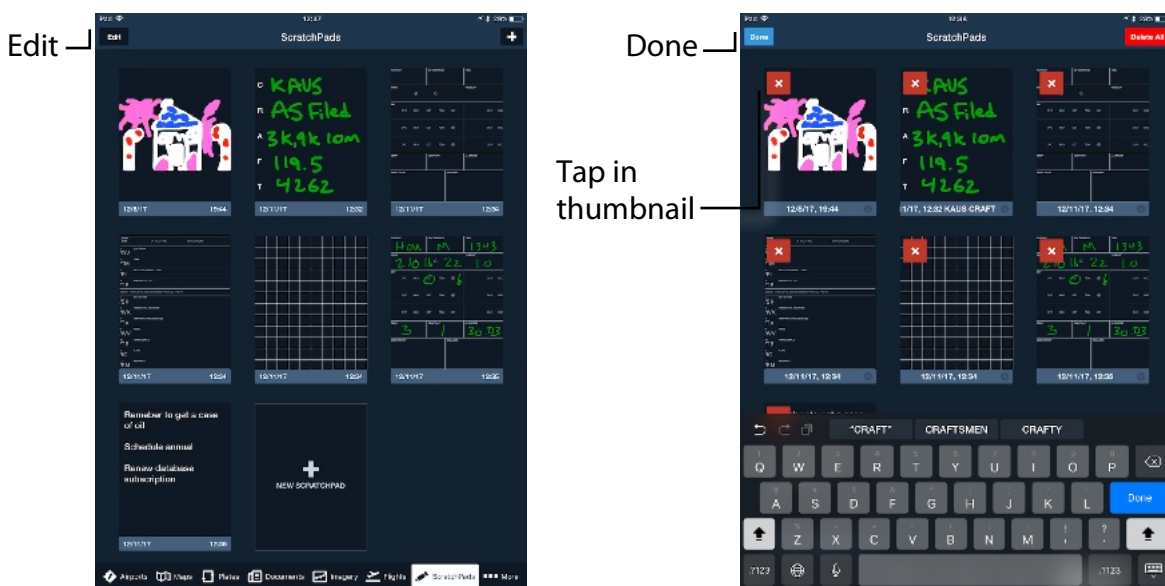

To rename a ScratchPad, close any ScratchPad so you're viewing the main ScratchPad page. Tap the "Edit" button in the upper-left corner of the screen, then tap the text you would like to edit in the blue area at the bottom of the ScratchPad. Type the new name, then tap "Done" in the upper left corner or on the keyboard.

Reposition ScratchPad Thumbnails

To change the position of ScratchPads thumbnails, tap the "Edit" button in the upper-left corner of the screen, then touch-hold on a ScratchPad thumbnail and drag it to the new position. Tap "Done" when you have finished repositioning the ScratchPad thumbnails.

Send a ScratchPad

Tap Send-To button to send a PDF copy of a ScratchPad via email or Message.

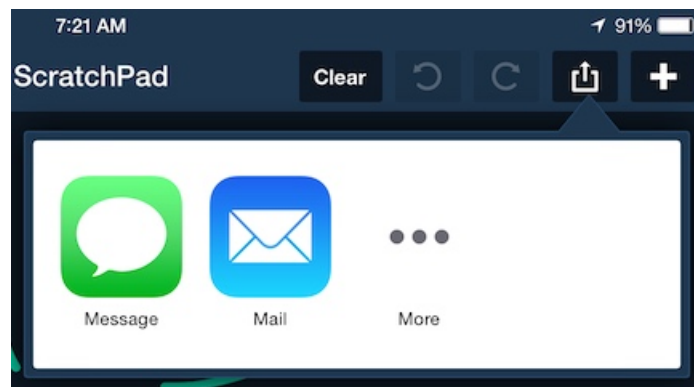

Delete a ScratchPad

From the main ScratchPads page, tap the "Edit" button (upper left) then tap the "X" button in the upper left corner of the thumbnail of the ScratchPad you want to delete.

IMPORTANT: ScratchPads are deleted immediately when you tap the "X."

Or tap the "Delete All" button in the upper right to Delete All ScratchPads, then tap the button to confirm deletion.

More

The *More* view provides access to important features and settings, such as downloads, aircraft profiles, Checklist and Logbook, application settings, and more. Tap the tabs on the left to view each of these different sub-views.

Downloads

About the Design

The *Downloads* view lets you keep ForeFlight Mobile up to date with the latest airport data, diagrams, procedures, charts, and documents. Select the data you want to download, then let the Automatic Downloads setting download new data whenever it is available (Wi-Fi connection required). Manually download new data whenever a red number shows on the “More” tab and Downloads menu. All the data you download is available offline, whether you’re up in the air or just away from an internet connection.

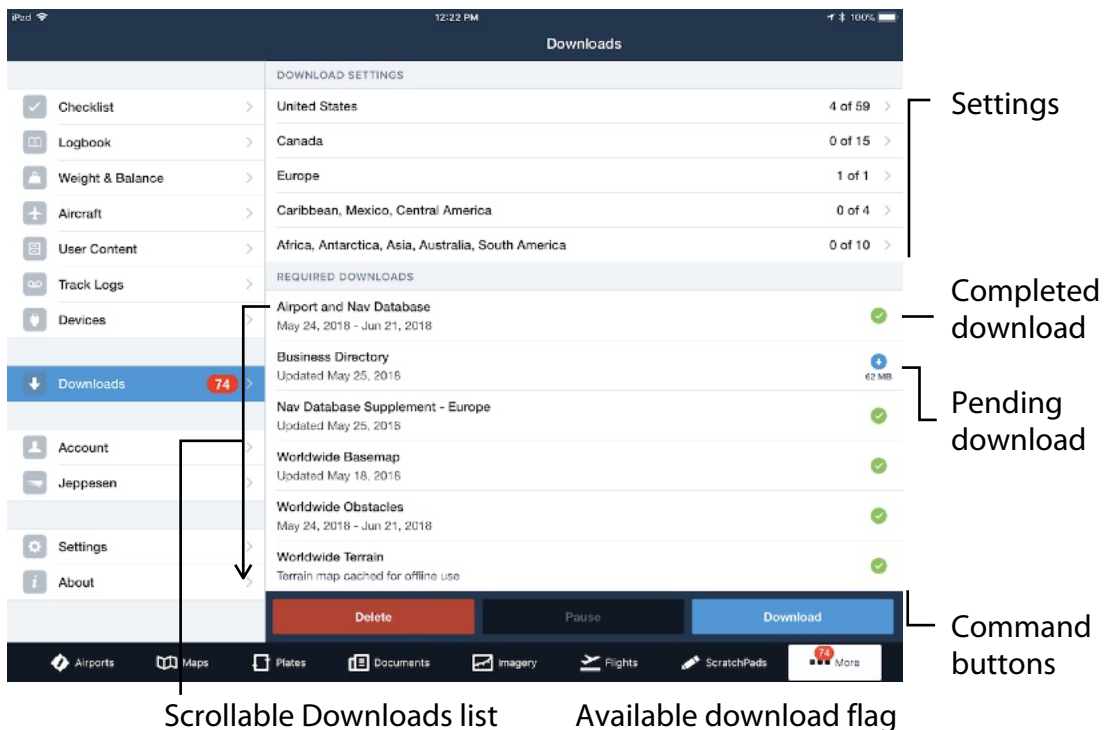

Automatic Downloads

To enable, choose “Activate” when the popup first appears after opening ForeFlight for the first time:

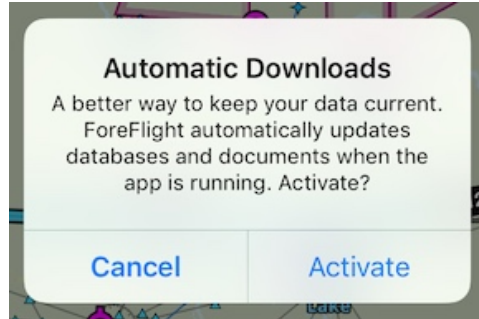

or tap More > Settings then scroll to the Downloads section and turn “Automatic Downloads” ON:

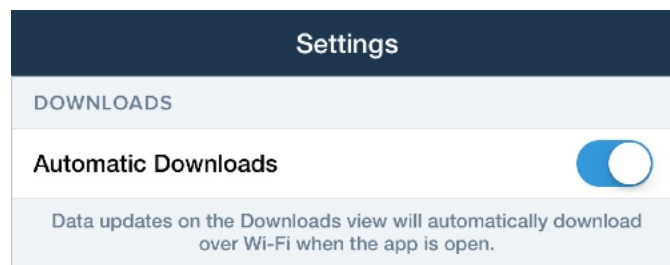

When Automatic Downloads is ON, downloads will begin automatically if your device is connected to a Wi-Fi network **AND** it has been more than 1 hour since you last manually downloaded new charts or data **AND** your device has sufficient storage space to download and install the pending downloads.

After installing ForeFlight Mobile for the first time, if your device is not connected to a Wi-Fi network but is connected to Cellular Data, Automatic Downloads will also display a prompt about downloading the Required Downloads using Cellular Data.

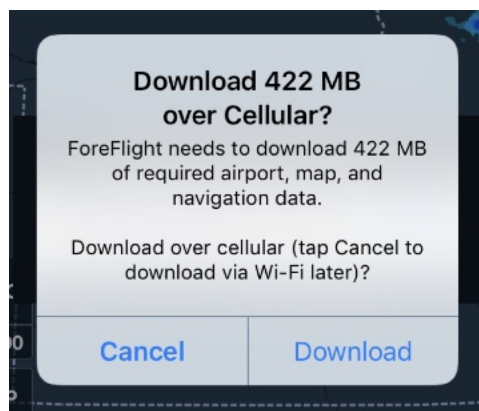

Delta Downloads

ForeFlight's Delta Downloads automatically downloads only the changes in months after an initial download of data. This provides for up to a 70% reduction in download time. Delta Downloads include terminal procedures, taxi charts, IFR and VFR charts, FAA A/FD, and Canada Flight Supplement data.

With Delta Downloads when you select a state for download in More > Downloads, if a chart crosses a state border, then the whole of that chart will be downloaded. For example North Dakota is covered by the Billings and Twin Cities VFR Sectionals, so ForeFlight Mobile will now download both of those charts if you select North Dakota.

South Dakota is also covered by the Billings and Twin Cities, as well as Cheyenne and Omaha VFR Sectionals. So selecting South Dakota will download all 4 Sectionals. Or if you previously had selected North Dakota, adding South Dakota will add just Cheyenne and Omaha VFR Sectionals.



Grouped Downloads

Delta Downloads groups downloads by state, resulting in less clutter on the Downloads page while also allowing you to expand the states to see the individual charts. States with a caret \triangleright next to them can be expanded and retracted by tapping the caret.

Downloaded charts that cross states that are not “subscribed” to, such as charts downloaded with Pack, are stored in a group called “Packed and Unselected Regions.” This makes it easy to locate and delete these charts when they are no longer needed and device memory is limited.

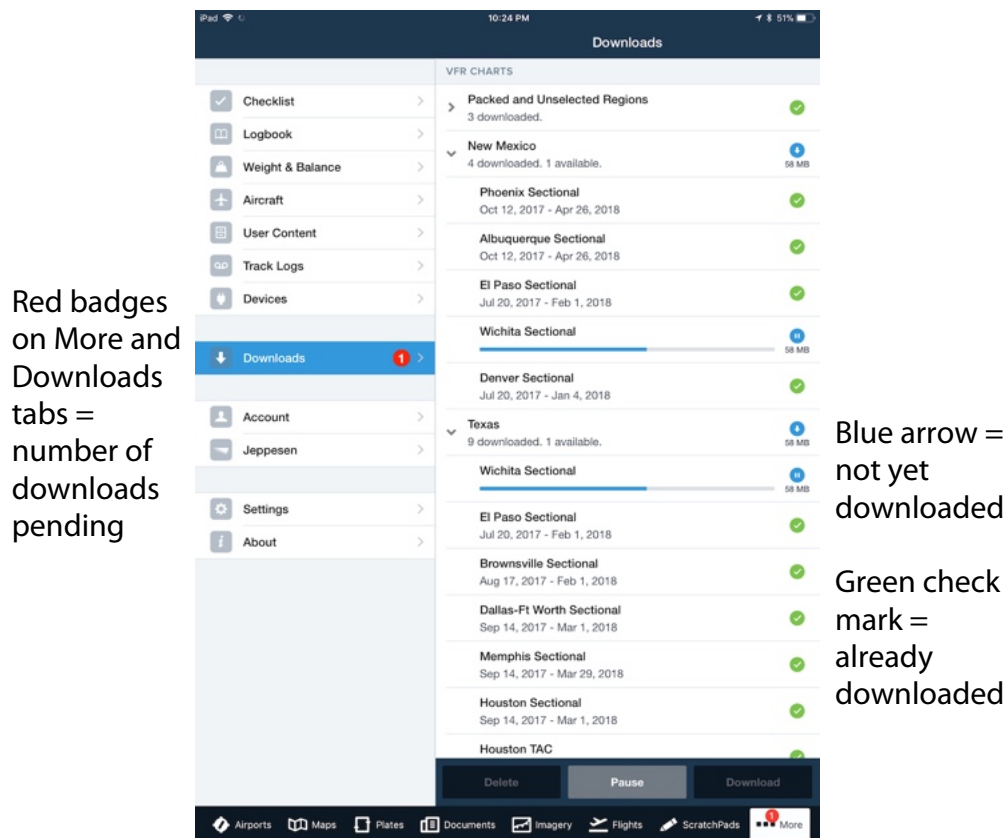

Because charts may cross multiple state borders, the same chart may appear under multiple state listings. In the example above, the Albuquerque Sectional is downloaded for both New Mexico and Texas.

Select Data to Download

When you first install the app, visit *Downloads* and select the data you'll need to bring with you. In *Download Settings* at the top, tap on the region in which you'll be flying. A view will slide in with the available data types for the country listed at the

top and an ON/OFF toggle switch next to each one.

Decide on the right data for your type of flying and toggle it to **ON**. VFR pilots will need *Taxi Diagrams & A/FD* and *VFR Charts*, but may not need *Terminal Procedures* or any IFR Charts. IFR pilots will also want terminal procedures along with low and/or high enroute charts.

Below the data types is a list of all states/provinces/countries in the region with available data. Tap on a region to select it - a check mark appears to the right of selected regions. To deselect it, tap again and the check mark disappears. U.S. pilots will want to select all of the states in which they regularly fly.

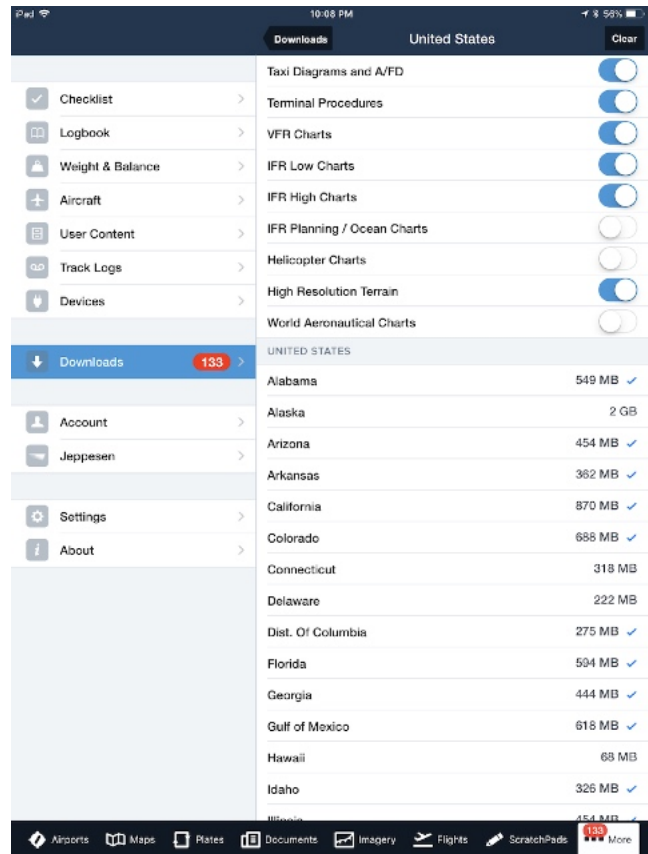

After you have finished selecting your regions, tap the **<Downloads** Downloads button in the top menu bar bar to go back to *Downloads*.

New listings with all of the data types and regions that you selected are displayed. For example, if you had toggled *Taxi Diagrams and A/FD* to ON and selected Texas and Louisiana, you'd see a table titled *Taxi Diagrams and A/FD* with the Texas and Louisiana diagrams. A blue arrow next to each region indicates that it is available to download. A green checkmark next to each region indicates that it has been downloaded.

If you'd like to download additional data types or choose new regions, go back into the *Download Settings* at the top. Continuing our example, if you were to set *Terminal Procedures* to **ON** and also select *Oklahoma*, the *Downloads* screen would add Oklahoma to the list of Airport Diagrams available for download and show a new *Terminal Procedures* table with Texas, Louisiana, and Oklahoma.

Downloading Data

Tap the blue arrow to download an individual region, or tap the blue **Download** button at the bottom of the screen to start downloading all of the data, two to four items at a time. You can stop the download at any time by tapping the **Pause** button. If you stop in the middle of a download, don't worry - it will automatically resume where it left off later.

When your download has finished, you'll see a green check mark on the right side. When all of the downloads have completed, the blue **Download** button at the bottom becomes disabled. All the data you downloaded can be used offline - you're now ready to fly!

Tip: if at all possible, use a *Wi-Fi* connection for these downloads. Downloads over the cellular network are much slower and, depending on your mobile contract, can result in bandwidth fees.

The new data for the next data cycle is generally made available to download 5-7 days before the effect date of the next data cycle. During that time, tapping the blue **Download** button will download data for both the current data cycle and the future data cycle.

Touch-hold on the blue **Download** button to choose to download only the Current data cycle data, or only the Future data cycle data.

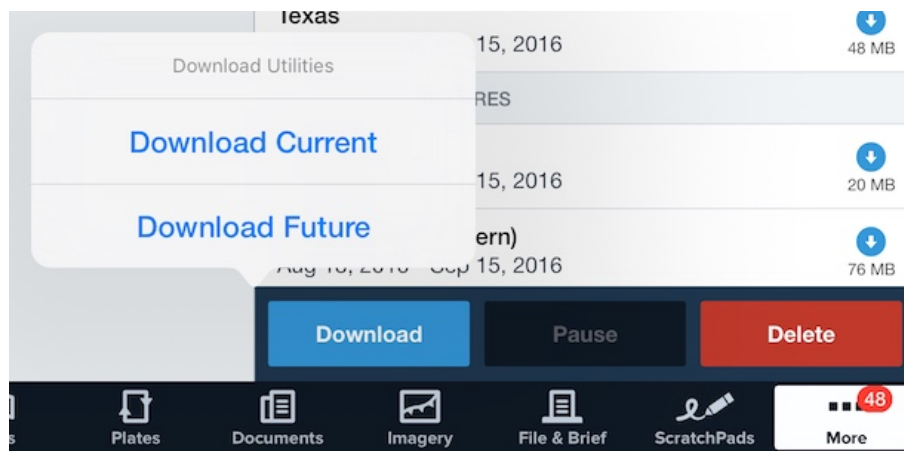

Downloading in the Background

Background downloading is currently available on devices running iOS 6 or later. However iOS 6 and later may halt a batch of background downloads before they are complete, especially if a large amount of data is being downloaded. Additionally, downloading will automatically stop if it was started when on a Wi-Fi connection and

the Wi-Fi signal is lost. A download batch that was started when on a cell-data connection will not continue in the background.

A Notification Center alert notification will be shown on the screen once the downloads are complete (or if they fail for any reason).

Keeping Current

New data is available every 28 days for diagrams, procedures, and VFR charts, and every 56 days for IFR enroute charts. A few days before the current data will expire, you'll see a red badge with a number appear on the **Downloads** button. This is the number of data downloads available for the next data cycle. When you see the red badge, it's time to download new data.

To download the new data, go to the *Downloads* view and tap the big blue **Download** button at the bottom. All data you've selected will queue up and download. If you don't already have a region downloaded or it's expired, then the new data will be used by the app immediately. If you already have current data for the region and you're downloading the new data a few days in advance, ForeFlight Mobile will save it on your device but keep using the current data.

The first time you start the app after the current data expires, the new data starts being used and the old data is deleted. This data cycle changeover happens automatically.

Deleting Data Downloads

All data downloads can be deleted by tapping the **Delete** button at the bottom of the *Downloads* view. The option is given to delete *All* data or just *Expired* data. Expired data is deleted automatically but for performance reasons, may not disappear immediately upon expiration.

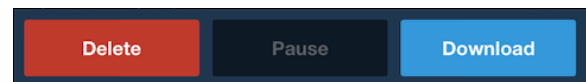

To delete an individual download, for example if a region has been downloaded that is no longer needed, swipe-to-delete the data row. Slide your finger from right to left across the entry you wish to remove and a red **Delete** button pops up. Tap on the button to remove the download. If you never want to download data for this region again, be sure to remove it from the list of regions that ForeFlight keeps track of for you by unchecking it in the *Download Settings* view.

Deleting an individual chart that appears under multiple states will remove it from all the states that it appears under. If a state includes charts present in other states, swiping to delete that state will display a popup to choose to delete only the charts that are unique to that state, or to delete all of its charts including those that appear under other states. If a state has only "unique" charts, no popup appears.

A Quick Tour of the Data Available for Download

- ❖ **Airport and Nav Database** is an international A/FD with over 27,000 airports and NAVAIDS from 220 countries. This data is used in the *Airports* view (frequencies, runways, hours, FBOs, etc) and in the *Maps* view (locations, routes, NAVAIDS, airspaces), and includes data used in the Aeronautical data layer.
- ❖ **Business Directory** contains the information about FBOs and services at airports.
- ❖ **Worldwide Obstacles** are Jeppesen-provided towers, bridges, etc. These are shown as markers on the Map view when the Obstacles or Hazard Advisor layers are enabled.
- ❖ **Worldwide Terrain** is the low-resolution terrain data used to add terrain features to the base map via the switch in Maps Settings. This map provides global coverage and is only available if downloaded.
- ❖ **Jeppesen Charts** can be added to ForeFlight and downloaded as separate downloads for enroute chart, IFR terminal charts, and VFR procedure charts. See [Jeppesen](#) for information on adding Jeppesen charts.
- ❖ **High Resolution Terrain** can be downloaded for any region on Earth to improve upon the low resolution terrain map. High Resolution Terrain for locations outside of N. America and Europe can be selected for download in the fifth Download Settings item: "Africa, Antarctica, Asia, etc."
- ❖ **Taxi Diagrams and A/FD (Aerodrome Charts and CFS/AIP for Canada and Europe)** contains thumbnail diagrams with FBO locations for over 1,200 worldwide airports and airport taxi diagrams. These are displayed at the top of an airport in the *Airports* view. Additionally, A/FD, CFS, and AIP pages for that region are included. These are displayed in the lower portion of the *Airports* view.
- ❖ **Terminal procedures** and approach plates, viewable in the *Procedures* tab of an airport in the *Airports* view.
- ❖ **VFR, IFR High, and IFR Low Charts** contains seamless sectionals and enroute charts for the U.S., southern Canada, and Europe for use in *Maps*.
- ❖ **IFR Planning / Ocean Charts** contains IFR planning and ocean charts for the U.S. and Atlantic and Pacific oceans for display on *Maps*.
- ❖ **VNC Charts** (Canada) contains Nav Canada seamless VNC and VFR Terminal Area (VTA) charts.

❖ **Helicopter Charts** - US Helicopter charts for 9 major metro areas (downloaded when switch is ON and containing state is selected) and US Gulf of Mexico VFR and IFR Helicopter charts (downloaded when Gulf of Mexico is selected).

❖ **Documents** are updated via this Downloads view once added to a binder in the Documents view.

Note: It isn't necessary to have all the data downloaded to make the app function properly. The downloads are only required for in-cockpit (or offline) use. Most pilots will download the states they will be flying through and leave other states alone if they are not flying there. If plans change, you can just grab the additional states in a few minutes of downloading. Downloading all items for all states can be unnecessarily time consuming - particularly if there are items you're likely to only reference when you're on the ground with an Internet connection.

Preflight Download Check

Remember: If it's not downloaded, you're not going to see it in flight.

Before your flight, make sure you have the necessary data downloaded:

❖ Use the [Pack](#) feature to automatically download relevant METARs, TAFs, AIR/SIGMETs, TFRs, Fuel prices and Airport NOTAMs.

❖ Go to **Settings** for your iPad and switch *Airplane Mode* **ON**. This will keep the app from retrieving data over the Internet, simulating the condition in flight.

❖ Launch **ForeFlight Mobile**

❖ Tap **More** and then **Downloads** and ensure there is a green check mark next to each region where you'll be flying.

❖ Tap **Airports** and search for each airport on your route. If you're flying IFR, make sure there is a green "saved" mark next to each procedure on the Procedures tab.

❖ Tap **Maps** and search for each airport on your route. Toggle between *VFR*, *IFR Low*, and *IFR High*, panning around each chart to ensure that it is downloaded properly on your device. Make sure to zoom into the airports you will be flying to and ensure that the charts are downloaded.

Troubleshooting Downloads

ForeFlight hosts all of the data for downloads on a network of servers located across the United States and around the world. When you start a download, the data comes from the server that is closest to you in order to provide fast and reliable downloads.

Depending on the amount of data you are downloading, download time can be considerable. If downloading all items for the USA, 8-10 GB of data will be downloaded. Even on a fast Wi-Fi connection, this will take a significant amount of time.

ForeFlight *strongly recommends* that you only download data for regions you will fly over or near. This will save a significant time and disk space.

Given the nature of networks and the large amount of data transferred every month, connection errors can occur. If a download fails, the app will automatically retry a few times. If you see a red error message on the download, that means the retry attempts did not work and you will need to restart the download for that particular item.

Try these troubleshooting tips:

❖ **Enable Diagnostic Logs** - in More > Settings, turn **Enable Diagnostic Logs ON** to save a log file of your download attempt. Then try the download again. If the download doesn't work, make sure that your Mail client is set-up with an email address that can send message. Then in ForeFlight Mobile, tap More > Settings then tap the word "Settings" in the header area at the top of the page, 3 times in quick succession. This creates a diagnostic email pre-addressed to the ForeFlight Pilot Support Team at team@foreflight.com. Send that email along with an explanation of your download difficulty and we will investigate.

❖ **Try downloading on another network** - if you're using your home Wi-Fi, try a download over a different Wi-Fi hotspot or, in a pinch, over 3G/4G.

❖ **Update the firmware on your router** - some older Wi-Fi routers are not compatible with the iPad. Visit your manufacturer's website to see if there is a firmware update available.

❖ **Reboot your iPad** by pressing and holding the button on the top of the iPad. A red slider appears on the screen - swipe where indicated to shut down your device. Wait a few seconds, then press the button again to start it back up. Once it has finished starting up, try the downloads again.

❖ **Double check Download Settings** to ensure the proper regions and data types are still selected.

Checklist

ForeFlight Checklist lets you complete a checklist with a series of taps, and also includes easy access to Abnormal and Emergency checklists. The app includes checklist templates for a variety of fixed-wing and select rotorcraft models, all derived from pilot operating handbooks. The templates can be customized as needed to fit your particular aircraft.

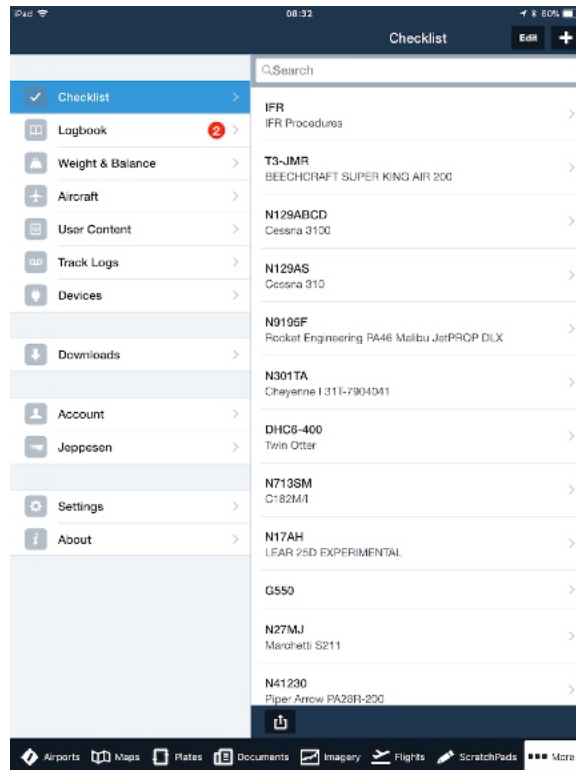

Checklist preserves your progress and location in a checklist if you tap away to another part of the app, such as the Maps view, and returns you right where you left off when you tap back into the Checklist.

NOTE: Checklist progress does NOT sync between devices. eg: a Checklist item checked on one device will not show as checked on another device. However, Checklist edits (changes) **do** synchronize between devices. Please read the important note in [Editing Checklists](#) before editing a Checklist.

Checklist also offers an option to “speak” the challenge or challenge/response.

Checklist is included with ForeFlight’s Basic Plus, Pro Plus, and Performance Plus subscription plans. Visit foreflight.com/pricing to upgrade your plan level to one that includes Checklist.

Setting Up Checklists

Tap the Plus button in the upper-right corner of the Checklist view to set up a new checklist. You can enter a tail number manually, or tap “Lookup Aircraft” to select from your list of configured aircraft - doing so does not affect the profiles in any way, it only copies their tail numbers. Entering a tail number is optional, as is entering a name for the checklist, but this can be useful if you want to identify a checklist by more than the tail number, such as with a specific mission type.

Tap “Template” to select from a list of preconfigured templates provided by ForeFlight. These templates are based on the operating handbook’s of various aircraft types and configurations. At the bottom are some templates not associated with any aircraft, including the “IMSAFE” checklist for determining readiness for flying and a “Passenger Brief” template. The default “Basic” template includes examples of each type of checklist component to help you build a checklist from scratch if you don’t use any template.

Checklists based on templates are fully editable after being created and do not affect the templates themselves in any way, so even if your particular aircraft type or configuration isn’t provided it can be helpful to start with a template for a similar aircraft.

IMPORTANT: After creating a checklist for your aircraft from one of the available templates, before using the checklist you must verify that all entries correspond to your aircraft’s POH.

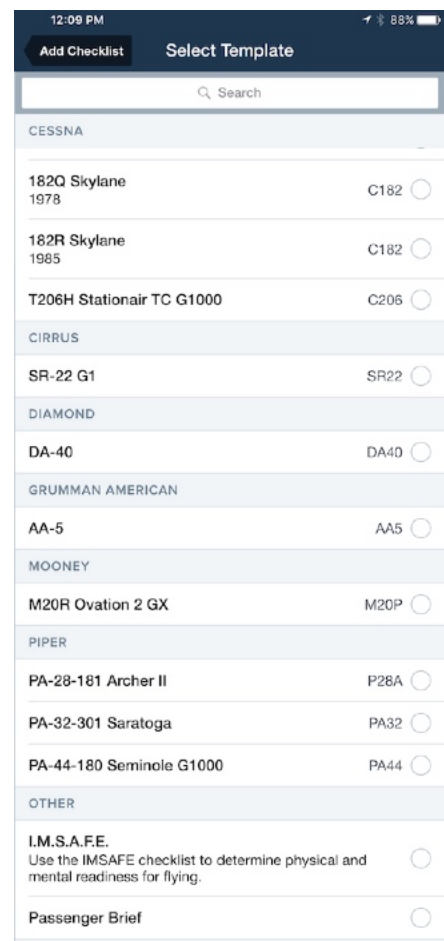
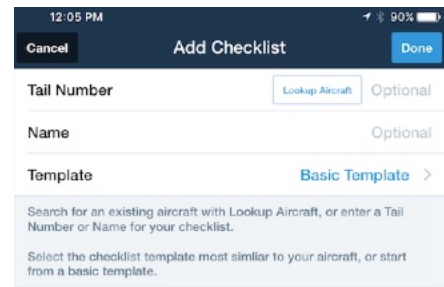

Category	Aircraft Model	Template Code
CESSNA	182Q Skylane 1978	C182
	182R Skylane 1985	C182
	T206H Stationair TC G1000	C206
CIRRUS	SR-22 G1	SR22
DIAMOND	DA-40	DA40
GRUMMAN AMERICAN	AA-5	AA5
MOONEY	M20R Ovation 2 GX	M20P
PIPER	PA-28-181 Archer II	P28A
	PA-32-301 Saratoga	PA32
	PA-44-180 Seminole G1000	PA44
OTHER	I.M.S.A.F.E. Use the IMSAFE checklist to determine physical and mental readiness for flying.	
	Passenger Brief	

Editing Checklists

IMPORTANT: When editing a checklist, your device must be connected to the Internet for the changes to synchronize. Also, make sure the checklist is open on only one device, and be sure to tap the “Done” button on that device before opening the checklist on another device.

All checklists include three “groups” for organizing lists: Normal, Abnormal, and Emergency. Apart from those three groups, every aspect of a checklist can be edited however you like, whether it is built from scratch or copied from a template.

Every page within Checklist has an Edit button in the upper-right - tap this to edit the contents of each page.

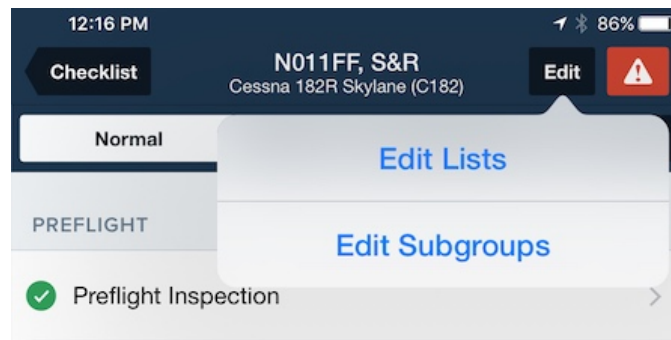

From the main Checklist view (where you can view all the checklists you’ve created) you can edit the tail number, name, and description of each checklist by tapping a checklist’s Edit button while in Edit mode. You can also re-order checklists by tap-holding on the far right and dragging them up or down, and delete a checklist by tapping the minus button on the left and then tapping Delete. You can also delete checklists without entering Edit mode using swipe-delete.

After tapping into a checklist, tap the Edit button to edit either the lists or subgroups within a given group (Normal, Abnormal, or Emergency). When editing subgroups you can change their names, re-order them, or delete them, and add new subgroups using the black button at the bottom of the screen. When editing lists you can change their names, change the group they’re in, or change the subgroup they’re in (which is based on which group they’re in).

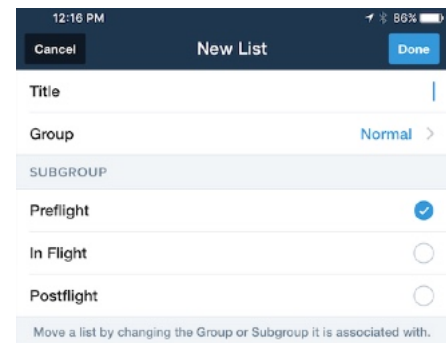
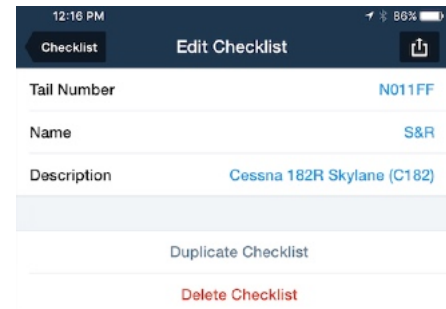

You can also re-order and delete lists, and add new lists using the button at the bottom of the screen.

Tap Edit while viewing a list to make edits to it. Tap Edit on a check item to change its “Challenge” or “Response”, and add optional notes that will appear at the bottom of the check item.

Tap Edit on a detail item (used to separate check items and provide information not associated with a check item) to change its title and text. Create new detail and check items using the buttons at the bottom of the screen and delete or re-order as on the other pages.

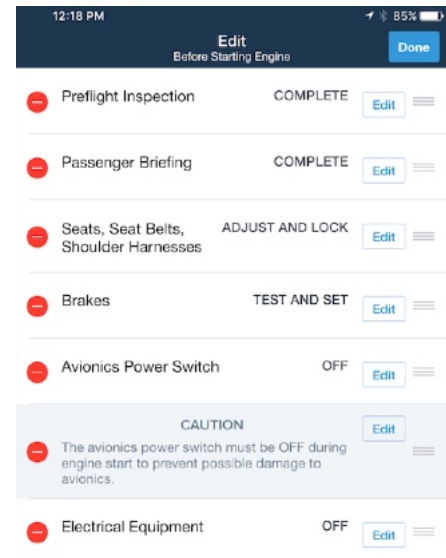

Using Checklists

After setting up and editing a new checklist so that it matches your POH, using it is very straightforward. Tap into a checklist and tap on a list to start using it. You can have the checklist read aloud, or you can read each entry and tap to acknowledge.

Speaking Checklist

To have the Checklist read aloud, tap the blue Speak button. In More > Settings you can configure whether the Checklist reads the Challenge, or both the Challenge & Response.

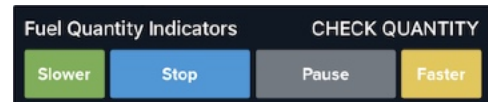

When the Checklist is being read, tap the blue “Stop” button to end the checklist readback, or tap the grey “Pause” button temporarily pause readback. Tap the yellow “Faster” or green “Slower” button to adjust the delay between checklist items.

The Checklist speak buttons will remain on the screen no matter which part of the app you are viewing.

Tapping Checklist

Use the Check and Skip buttons at the bottom of screen to check or skip check items, or tap directly on an item to check it.

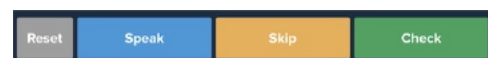

When you check an item, the empty circle on the left turns green with a checkmark; when you skip an item, the circle turns yellow.

As you check or skip items, the selection indicator advances down the list, allowing you to move through an entire list using only those two buttons. You can clear a checked or skipped item by tapping on it, allowing you to quickly check off previously skipped items, or clear items that you want to re-check.

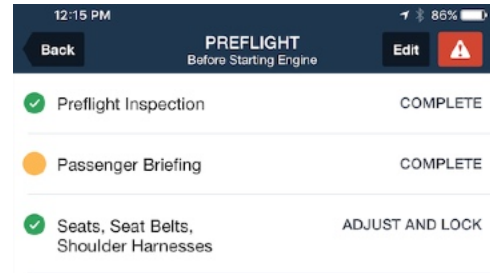

Once you've checked or skipped every item in a list, a blue Next button replaces the Skip and Check buttons at the bottom of the screen, allowing you to jump straight into the next list.



Use the Reset button in the lower-left corner of a list to clear all items within that list. The Reset button can also be used when viewing a checklist to clear every list within that checklist. **NOTE:** Resetting a checklist also clears lists in other groups that you can't see from the group you're in.

If you tap the Back button in the upper-left to leave a list before completing it, your progress in that list is indicated by a circle that fills in as you complete more of the list. Once fully completed the list is marked with a check.

The red Emergency button in the top-right is available on every page within a checklist for quick access. Tapping it will place you directly into the Emergency list group, allowing you to select and begin using one of the emergency lists.

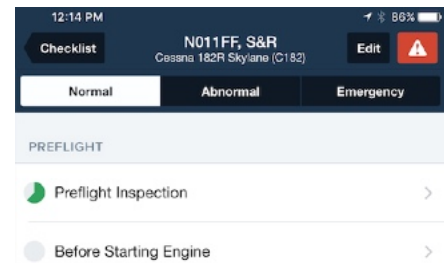

Sharing Checklists

From the main Checklist view, tap the Send To button at the bottom of the screen. Tap on the checklist that you want to share and tap the Share button in the upper-right. Tap on a nearby iPad's/iPhone's name to share it with AirDrop, or tap Mail (or another email app) to create a new email draft with the checklist's file attached.

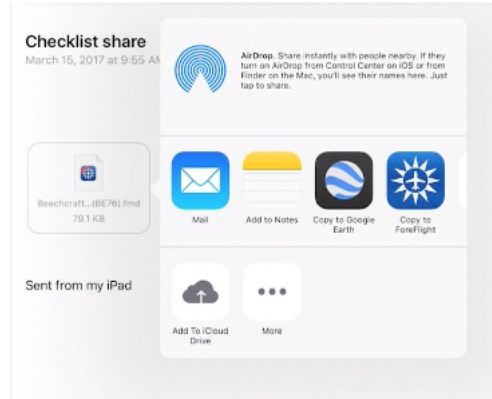
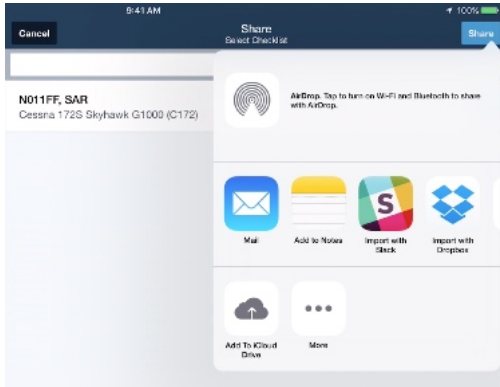

Checklists received via AirDrop will automatically be imported into ForeFlight Mobile, which will open and jump to the Checklist view so you can see the new checklist. If you receive an email with an attached checklist, tap on the attachment and tap “Copy to ForeFlight” to import the checklist and open ForeFlight to the Checklist view.

Checklist files can only be opened and edited within ForeFlight Mobile.

Logbook

The Logbook feature lets you track your hours, currency, ratings, endorsements, medical certificates, and more across all your devices. It is included in the Basic Plus, Pro Plus, and Performance Plus subscription plans.

Your current logbook can be imported from ForeFlight on the web for easy transfer of data, and new entries can be entered manually, or automatically if Track Log auto-start/-stop is enabled. And beginning with ForeFlight version 11.9, you can specify fields to fill automatically based on a flight's total time.

Aircraft can be copied directly from your current aircraft, and people can be copied from your contacts and assigned various roles for each flight such as SIC, instructor, student. An endorsement feature allows instructors to sign off on a student's progress with a digital signature.

Pilots can also export a flight experience report or FAA 8710 that can be used for completing annual insurance forms, rental applications, and job applications. And new Logbook Detail Reports (in either complete or condensed versions) transform your digital flight entries into a print-ready layout for personal backup or professional job interviews.

Logbook supports currency tracking for jet pilots based on the requirements outlined in FAR 61.58, allowing you to stay prepared for your proficiency check. You can add your initial endorsement in the Qualifications section, then track and update your 12 and 24 month proficiency in one or more aircraft types using Logbook entry flight tags.

Logbook is part of the ForeFlight Cloud, allowing you to make new entries and track your currency from any device signed into your account.

Logbook can also automatically suggest adding pictures taken during the time of the flight to the logbook entry.

For complete details, see the **Logbook in ForeFlight Mobile** guide in Documents > Drive > ForeFlight, or at www.foreflight.com/support.

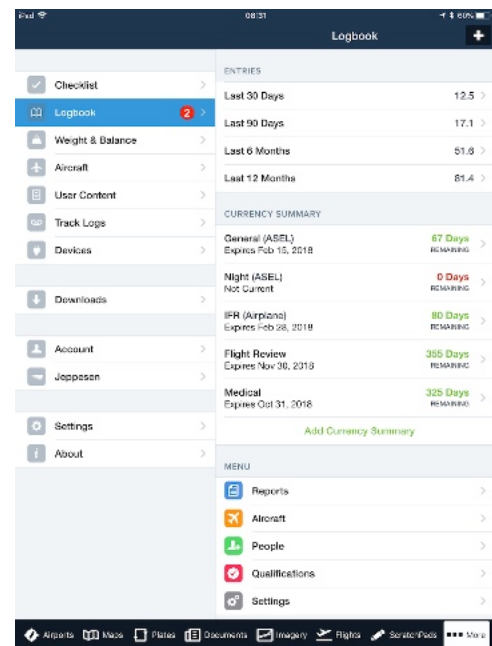

Weight & Balance

The Weight & Balance feature allows you to quickly determine whether your aircraft is loaded within its envelope, an important part of every pre-flight. It is included in the Basic Plus, Pro Plus, and Performance Plus plans for individuals, as well as the Business Pro plan for multi-pilot business subscribers.

The Weight & Balance feature can be used for **fixed-wing** aircraft that meet these requirements:

- ❖ **Constant weight limits (i.e., weight limits do not vary with CG)**
- ❖ **CG is in length units, not %MAC**
- ❖ **Takeoff and Landing CG limit envelopes are the same**
- ❖ **Only 1 fuel moment table (i.e., a single variable-arm fuel station)**

Weight & Balance includes the SmartOptions™ interview, which uses data from Type Certificates to allow you to answer a few questions to quickly set up your aircraft's W&B profile based on its tail number and the empty weight, moment, and CG from the POH.

The SmartOptions™ interview is available for many popular Cessna, Cirrus, Diamond, Mooney, and Piper aircraft.

Once your aircraft's W&B profile is set-up, you can quickly create a Loading Summary for each flight, and you can share the profile and a PDF copy of the Loading Summary via email. W&B profiles are automatically [synced](#) between your devices when Synchronize User Data is enabled in More > Settings.

For full details, see the **Weight & Balance in ForeFlight Mobile** guide in Documents > Drive > ForeFlight, or at www.foreflight.com/support.

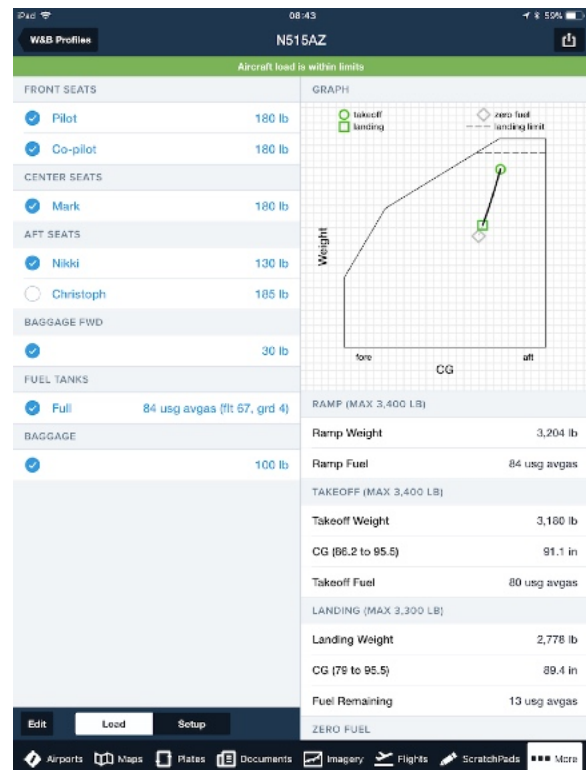

Aircraft

If you have a Performance Plus or Business Performance subscription, please refer to the Performance guide (available in the app in Documents > Drive > ForeFlight) or online at <http://foreflight.com/support/performance/pdf> for additional details about the Performance flight planning features.

NOTE: For creating and editing aircraft in ForeFlight [Logbook](#), please refer to the **Logbook in ForeFlight Mobile** guide in Documents > Drive > ForeFlight, or at www.foreflight.com/support.

Create or Edit an Aircraft

If you have an extensive list of aircraft, you can filter the list by aircraft type or N-number.

Create a new Aircraft on the More > Aircraft tab by tapping the “+” button to create a new Aircraft from scratch, or by tapping the “>” to the far right of an existing aircraft, scrolling down, and tapping “Copy Aircraft.”

Edit an Aircraft by tapping the “>” at the right of an existing Aircraft.

The General section includes basic information about your aircraft like the Tail Number, aircraft color, and Home Airpot. The Aircraft type (used for filing flight plans) includes a built-in type code lookup. Tap “Aircraft Type” then enter the aircraft model or make in the search box. Scroll through the list to find the correct aircraft, the tap that entry to set it as your aircraft’s type code.

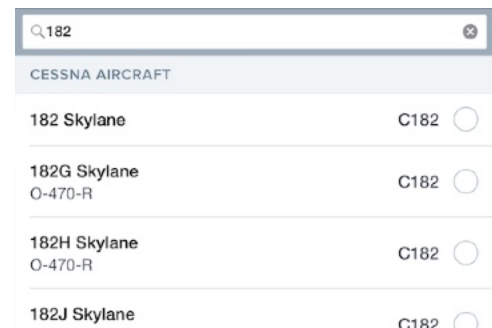
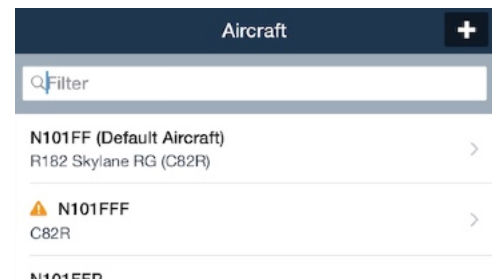

In the **Glide Performance** section, enter your aircraft's Best Glide Speed and Best Glide Ratio. For the Best Glide Ratio, enter the part before the :1. eg: For a ratio of 7.8:1, enter only 7.8 with no : or :1.

The Default Cruise Altitude sets the default Flights altitude, and the Maximum Ceiling sets the upper cut-off for the Altitude Advisor. Not entering a value for Maximum Ceiling will result in the Altitude Advisor returning results up to FL570.

The Start/Taxi/Takeoff Fuel is the number of units (typically gallons) of fuel that your aircraft burns during Start, Taxi, and Takeoff.

IMPORTANT: Mistakenly entering a value as gallons per hour, instead of the total number of gallons burned during start, taxi, and takeoff may result in erroneously high fuel burn values for the trip.

The Filing section includes the ICAO equipment needed to file a flight plan. For full details about ICAO Equipment, ICAO Surveillance (eg: transponder or ADS-B Out), see the "Filing with ForeFlight" guide in More > Documents > ForeFlight, or online at <https://foreflight.com/support/filing/pdf>.

GLIDE PERFORMANCE	
Best Glide Speed	
Best Glide Ratio	
ALTITUDES	
Default Cruise Altitude	8,000
Maximum Ceiling	18,000
FUEL	
Fuel Type	100LL
Fuel Units	Gallons
Start/Taxi/Takeoff Fuel	

Aircraft	N101FF
FILING	
FAA Equipment	/G
ICAO Equipment	G, S
ICAO Surveillance	None
ICAO Wake Category	L
ICAO PBN	None
Other Information	0 items
STS Special Handling	None
DINGHY	
Count	
Capacity (Persons)	
Color	
Covered	<input type="checkbox"/>
EMERGENCY	
Life Jackets	None
Radios	None
Survival	None
Survival Equipment Remarks	
Make Default	
Copy Aircraft	

Basic Performance Profile

The Performance section lets you create one or more basic performance profiles (eg: climb, cruise, and descent performance) for your aircraft. To create a profile, tap Performance Profiles, then tap "Add Custom Performance Profile."

You can create as many profiles as you wish for each aircraft, but only one profile will be used for a particular flight.

Name the profile, then at minimum enter the Cruise TAS and fuel burn. For more accurate performance calculations also enter the Climb and Descent TAS, fuel burn, and rate of Climb/Descent.

When you finish entering the information, tap the <Performance Profiles button to go back to the Performance Profiles menu. To set a particular performance profile as the Default for that aircraft, tap the Profile, scroll down, and tap "Make Default."

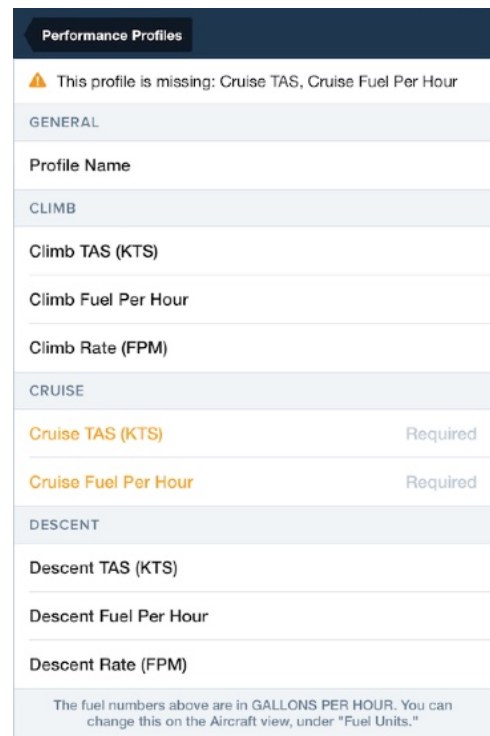
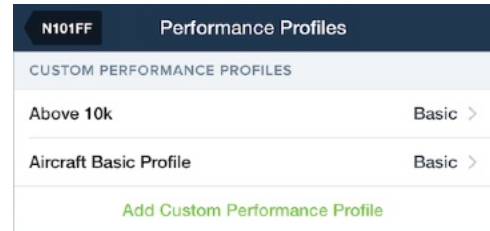
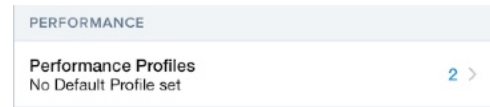

Sharing an Aircraft with another account

Beginning with ForeFlight Mobile 11.7 a **read-only** copy of an Aircraft can be sent to another account via Email, AirDrop, or Message.

NOTE: The recipient of a shared Aircraft must be running ForeFlight Mobile 11.7 or later. Earlier versions of ForeFlight Mobile cannot access shared Aircraft.

If an Aircraft is shared by a Performance Plus account to a recipient who has Basic Plus or Pro Plus, the recipient will not have access to ForeFlight Performance profiles or by-altitude profiles, but will have access to any Basic Performance Profiles

After an Aircraft is shared, any changes made by the pilot who shared the aircraft will be reflected in the recipient's copy of that aircraft. This also means that if the pilot who shared the aircraft deletes the aircraft from their list, it will be removed from the recipient's Aircraft list as well.

To share a **read-only** copy of an Aircraft with another pilot, tap on the Aircraft's entry to open it, then tap on the "Send to" button in the upper-right, tap "Share Aircraft", and choose from the available options: Message, Mail, and AirDrop.

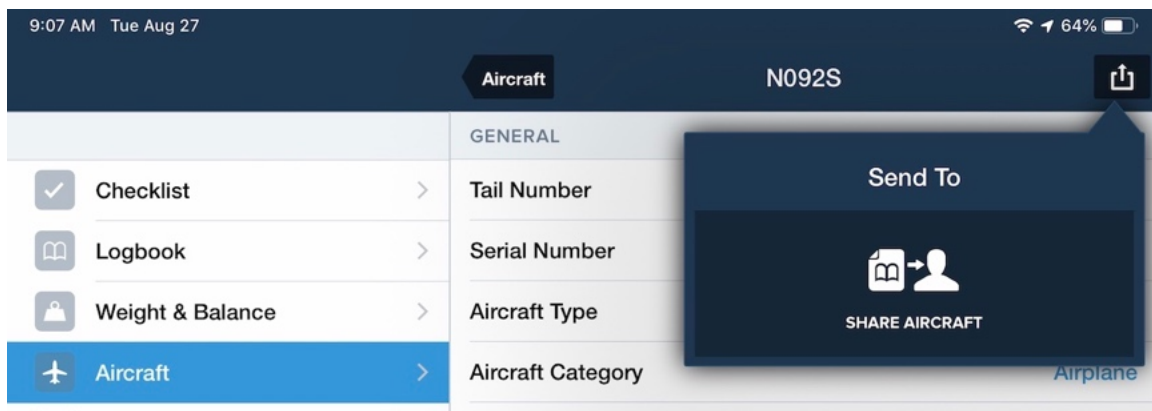

If shared via email or Message, the recipient should tap the link in the email to open ForeFlight Mobile. If shared via AirDrop, ForeFlight Mobile will automatically open.

Tap "Accept" to add the read-only copy of the shared aircraft to your Aircraft list, or tap "Deny" to cancel and not add the aircraft to the list.

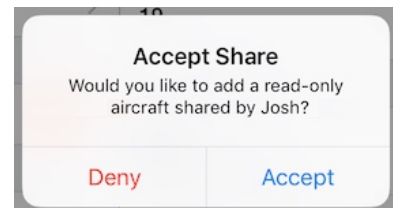

Shared Aircraft appear in the Aircraft list with a small grey icon and the name of the pilot who shared the aircraft with you.

IMPORTANT: To make changes to a Shared Aircraft, the Aircraft must be copied to the recipient's account. Tap the Shared Aircraft profile to open it, scroll down to the bottom, then tap "Copy Aircraft". This will create a fully editable copy of that aircraft. After the recipient makes a copy of the Aircraft, if the pilot who shared the aircraft deletes the aircraft from their list, the Shared Aircraft will be removed from the recipient's Aircraft list but the copy will remain in the recipient's Aircraft list .

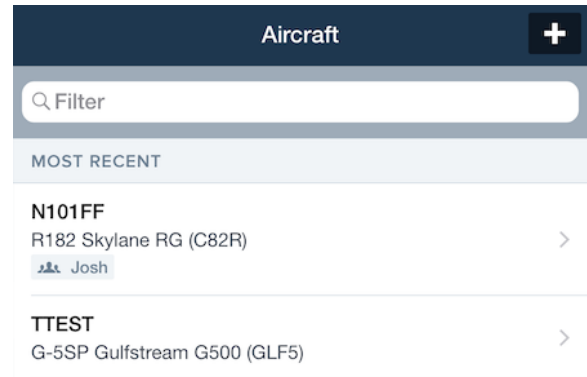

Delete Aircraft

To delete an aircraft, swipe your finger from right to left across the entry, then tap the red Delete button.

Manage Aircraft for Multi-Pilot Accounts

Multi-pilot account administrators can manage and distribute company aircraft profiles to all the pilots on an account, allowing for easier aircraft management and reduced setup time for large accounts.

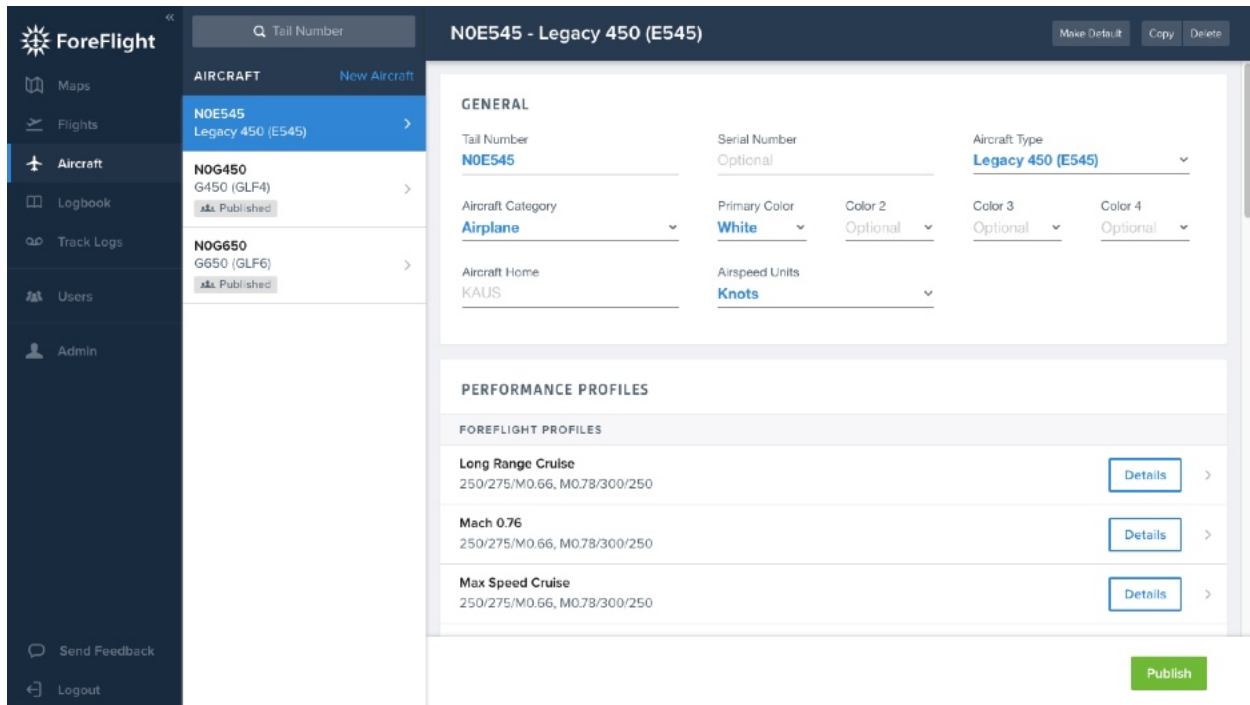

To set up company managed aircraft profiles as the administrator of a multi-pilot account, sign in to ForeFlight’s [web application](#) using your username and password, then click the Aircraft tab on the left-hand nav bar. Select an aircraft that you want to share or set up a new one with the necessary details. At the bottom-right of the page is a green “Publish” button. Click this button to share the aircraft with all users on the account. Once shared, a “Published” tag will appear under the aircraft in the list view on the left, and the bottom of the page will show the date and time when you published the aircraft.

Last published on 10/01/2017 2:16pm.

Unpublish

Any time you make changes to a shared aircraft, “(Unpublished Changes)” will appear in green at the bottom of the page, and a “Publish Changes” button will appear in the bottom-right. The changes will not be shared with users on the account until you publish them. Doing so will update the “Last published” date and time at the bottom of the page.

Clicking “Unpublish” will revoke access to the aircraft for all users other than the administrator, and they will no longer be able to see or use the aircraft for flight planning, although a record of the aircraft’s tail number will remain attached to flight plans made with that aircraft.

The administrator cannot delete a published aircraft - he or she must first unpublish the aircraft, then delete it.

Aircraft that have been published by an account administrator will appear in the Aircraft list’s of all pilots on the account, along with a tag showing the email address of the administrator who published the aircraft. Pilots on the account can view the details of shared aircraft and use them for flight planning as they would their own aircraft, but all details of the aircraft are locked from editing by the pilots, including the performance profiles. Published aircraft include a message at the top of the aircraft detail view with the email address of the administrator who published the aircraft and the time and date of last publishing. Users can tap the email address to create an email to the administrator.

Pilots cannot delete shared aircraft, but they can use the buttons at the bottom of the aircraft detail view to make a shared aircraft the default for flight planning, and to copy a shared aircraft. Copying a shared aircraft creates an identical aircraft profile that they can edit, allowing them to make changes to the aircraft without affecting the original shared aircraft. Copies of shared aircraft are the same in all respects as new aircraft created by the pilot: they cannot be viewed or modified by the account administrator, and changes published to the original shared aircraft will not affect the copy.

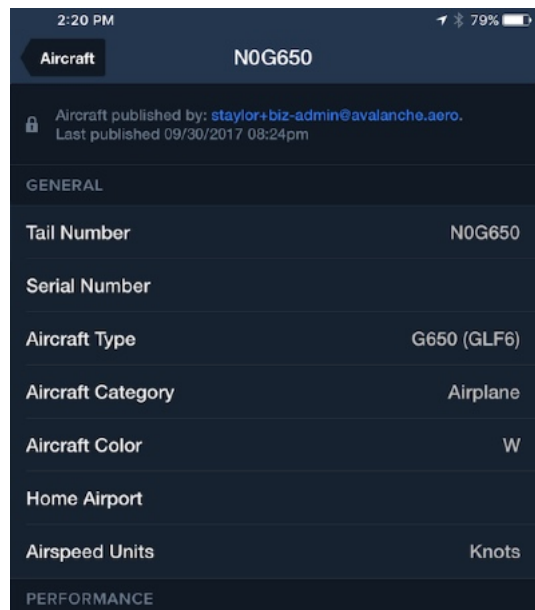
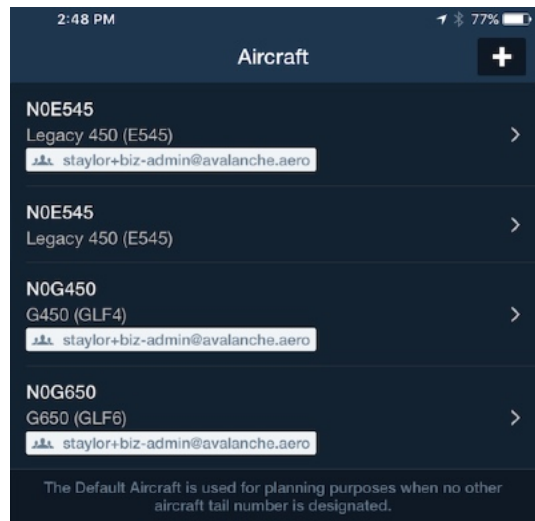

Custom Content

The Custom Content tab is where you can manage custom content that you've created or imported into the app, including Custom Charts (.mbiles files), Custom Map Layers (.kml and .kmz files), User Waypoints (.kml or .csv files), and Content Packs.

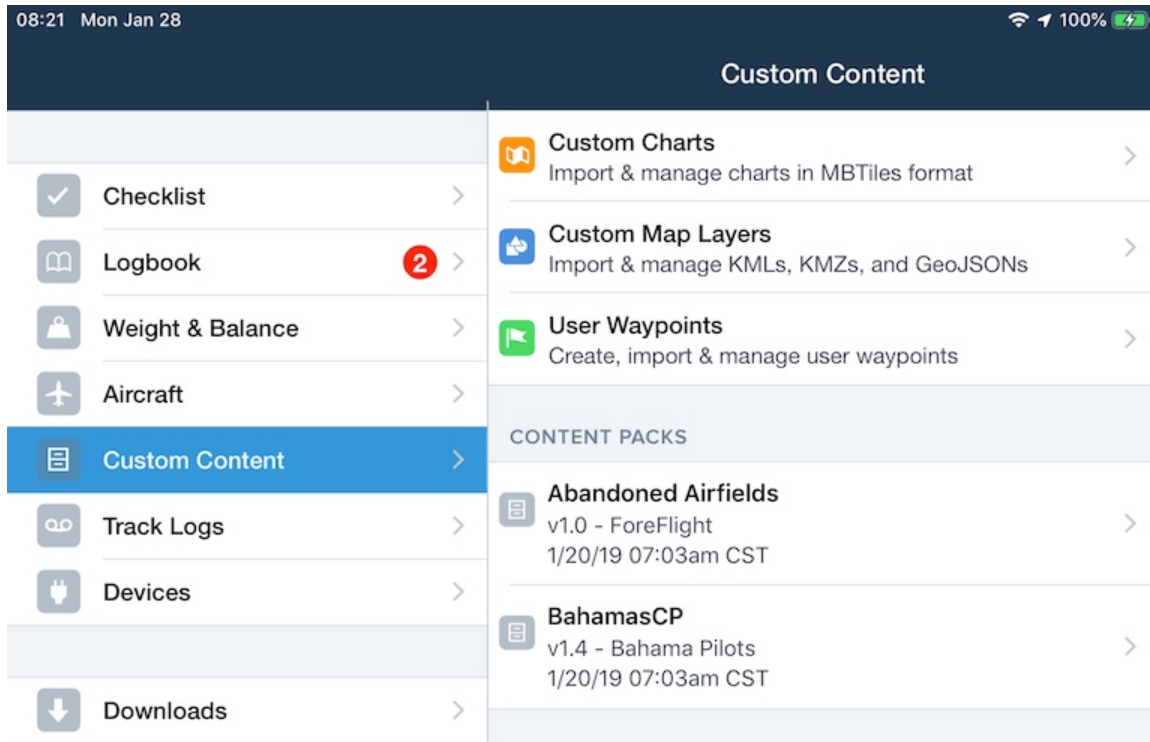

Importing Custom Content files

Custom Content files (other than .csv User Waypoint files) can be directly imported into ForeFlight from the Apple Mail app, a browser, or the Dropbox app, and they can be sent directly to an iPad or iPhone via AirDrop.

- From Mail, touch-hold on the file...;
- From Safari, tap on the file, then tap on "More...";
- From Dropbox, tap the 3 dots button in the upper-right, tap Export, then tap Open In...;

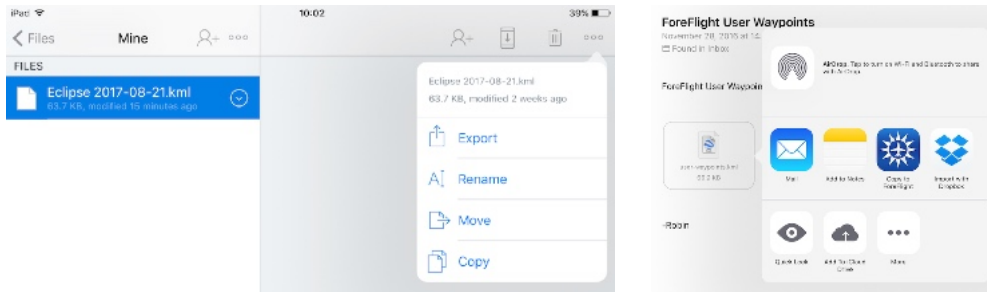

Then tap “Copy to ForeFlight” in the popup.

If an imported KML file contains user waypoints, a popup will open so you can choose whether to import the points as User Waypoints or as a User Map Layer. Importing new user waypoints does not delete any user waypoints that are already in ForeFlight, unless they have the same name (e.g. “HOME”), in which case the new waypoint will replace the original.

To import a file using AirDrop from a Mac, right-click on the file then choose AirDrop.

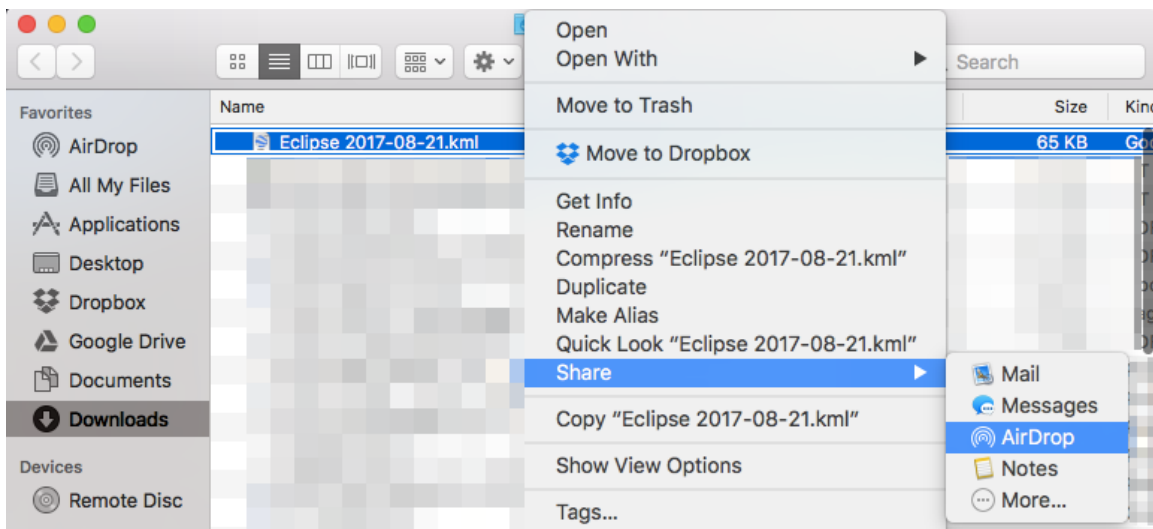

A popup will open showing all available iOS devices. If yours does not show-up, open the System Tray by swiping-up from the bottom and turn Air Drop Receiving ON. When you find your device, tap it to bring the file transfer. On your iOS device you will see a popup asking with which app the file should be opened. Tap ForeFlight.

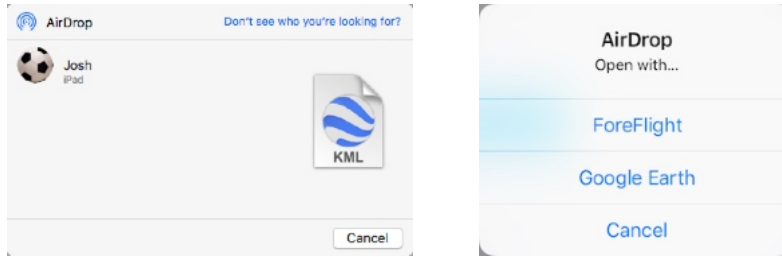

Custom Content files can all also be imported by connecting the device to a laptop or desktop computer running iTunes:

Open iTunes, then plug-in the device. Click on the device icon, click on Apps in the left-hand menu, then scroll the page down to the File Sharing section. Click on ForeFlight in the left Apps menu, then drag the file(s) into the “ForeFlight Documents” section on the right. See <https://foreflight.com/support/user-content/> for additional details about importing using iTunes.

Deleting Custom Content

Tap on the appropriate category, swipe from right to left across the item you want to delete, and tap the red Delete button. You can also tap the “Edit” button in the top-right to delete individual items or to delete all files in that category.

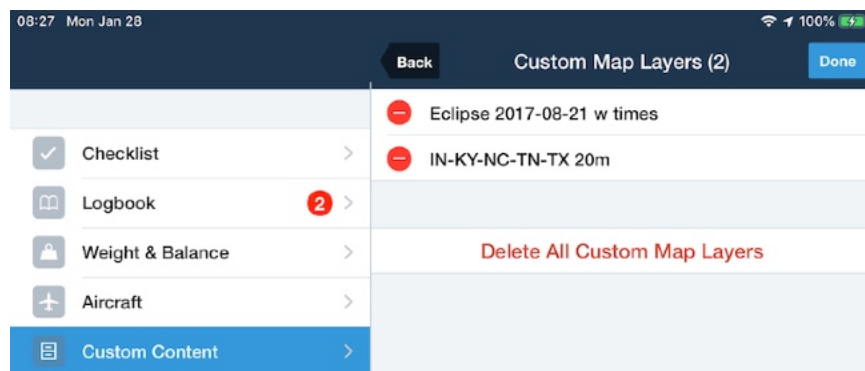
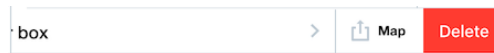

Sharing User Waypoints

You can export your user waypoints as a KML file and send them via email. Tap the Send To button in the bottom left of the User Waypoints page and tap Mail to create a draft email with the KML file attached. **NOTE:** You must have an email account set up in your device's Apple Mail app for the mail option to appear.

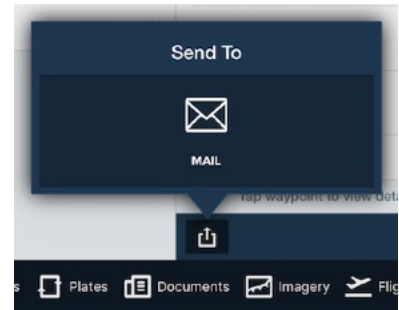

Creating User Waypoints

User Waypoints can be created by touch-holding a location in the Maps view. To create a User Waypoint, tap-hold the point when you want to create a waypoint until the popup is displayed. Tap the **More** button next to the Lat/Lon coordinates, then tap the blue **Save** button underneath the Lat/Lon coordinates to name and create the user waypoint.

❖ **Name:** The app suggests a waypoint name based on how the user waypoint is created (via an address or other search, or by touch-holding on the map) but you can change this as needed. Names must be at least 3 characters long, all one word with no spaces, and must contain at least one letter. Once a waypoint has been named, you'll be able to reference it while creating routes just as you would any other waypoint.

❖ **Description:** (Optional) Provide a brief description of the waypoint. The description appears in the waypoint callout when you tap that waypoint in your route in the Maps view.

❖ **Lat/Lon:** When creating a user waypoint via touch-planning, the latitude and longitude are determined for you based on the point on the map that you touch. Lat/Lon coordinates can be entered in [4 different formats](#).

You can also enter a user waypoint as a distance and radial from an aviation point by entering the point/radial/distance information in Latitude and leaving Longitude blank. For example, entering GEP/125/10 in Latitude would create a user waypoint 10 NM away from the GEP VOR on the 125 Radial.

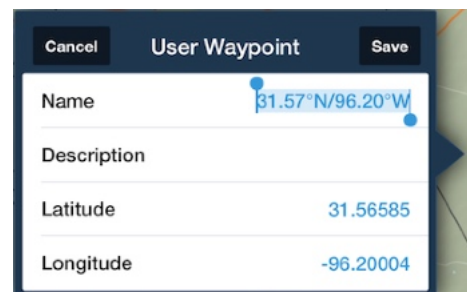
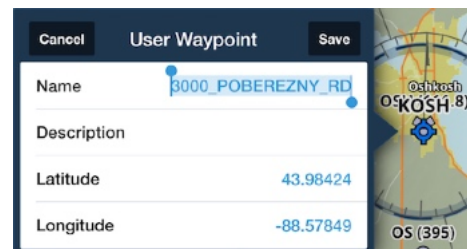

You can also enter a User Waypoint using the MGRS@... format described in the Search & Rescue Supplement, found in Documents > Drive > ForeFlight. Similar to the point/distance/radial method above, enter the MGRS@ point in Latitude and leave Longitude blank.

To edit an existing user waypoint's details, tap the  button next to the waypoint.

Once the waypoint is created, it functions just as any other waypoint in ForeFlight Mobile.

To **delete** a single user waypoint from your device, tap More > User Waypoints and use the swipe-to-delete gesture: swipe your finger across the name of the waypoint, then tap the red Delete button. To delete ALL User Waypoints, tap the "Clear" button.

Latitude/Longitude Formats

For input of latitude/longitude in User Waypoints or the Search box on the Maps page, 4 formats are supported:

- ❖ DD.dd
- ❖ DD MM SS
- ❖ DD MM.mm
- ❖ DD MM SSs

Examples of these formats using this location 32°44'55.6"N, 80°45'57.6"W are:

- ❖ DD.dd 32.75N/080.77W
- ❖ DD MM SS 324456/-0804558
- ❖ DD MM.mm 3244.93/-08045.96
- ❖ DD MM SSs 3244556/-08045576

NOTES:

- 1) Latitude is always DD, and Longitude is always DDD.
- 2) Include a minus sign for Longitudes west and Latitudes south.
- 3) Regardless of the input form used for a User Waypoint, it is automatically converted to DD.dd format storage.

For reading Airport coordinates and ad-hoc tap-and-add coordinates ForeFlight allows you to select from 3 formats:

DD.dd

DD MM.mm

DD MM SS

To change formats within ForeFlight Mobile, go to **More > Settings > Units/Time > Coordinates** and select the format you want.

Custom Map Layers

The Custom Map Layers feature enables you to import and display custom KML shape files as well as KMZ files (which can contain multiple KML files as well as custom icons) over any map.

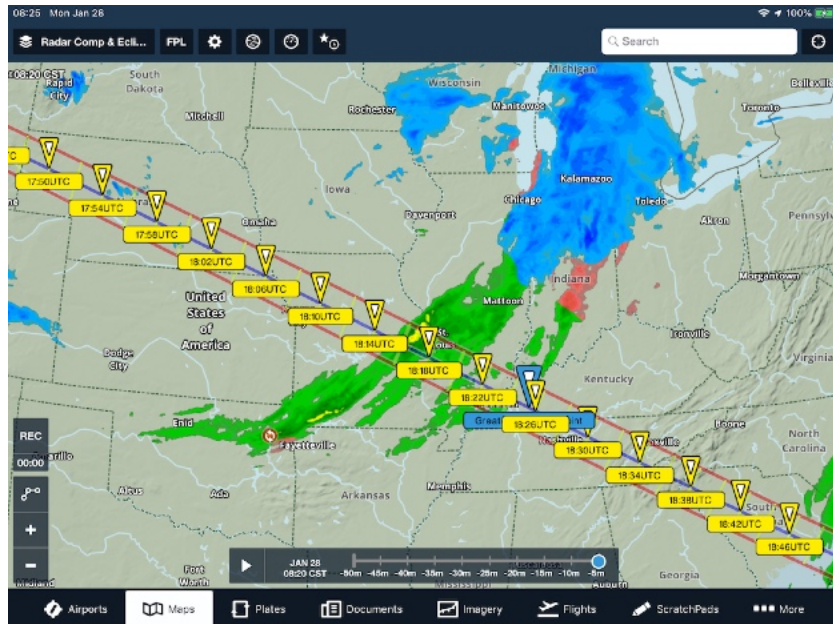

Multiple KML/KMZ files can be displayed at a time. All KML/KMZ files that have been imported are shown in the list on the bottom of the right column in the Map Selection drop-down menu, and in the Custom Map Layers section of More > Custom Content. Visit <https://foreflight.com/support/user-content/> to learn more about Custom Map Layers.

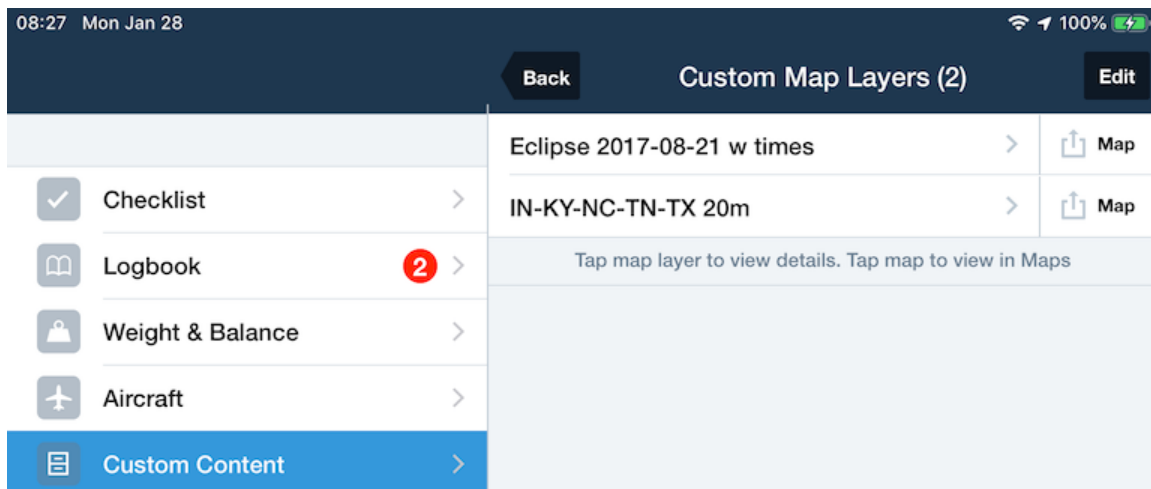

Custom Charts

The Custom Charts feature allows you to import custom georeferenced charts in .mbtiles format and display them on the Maps view on top of other charts. Multiple custom charts can be displayed on the map at a time, and you can display custom map layers and user waypoints at the same time as custom charts.

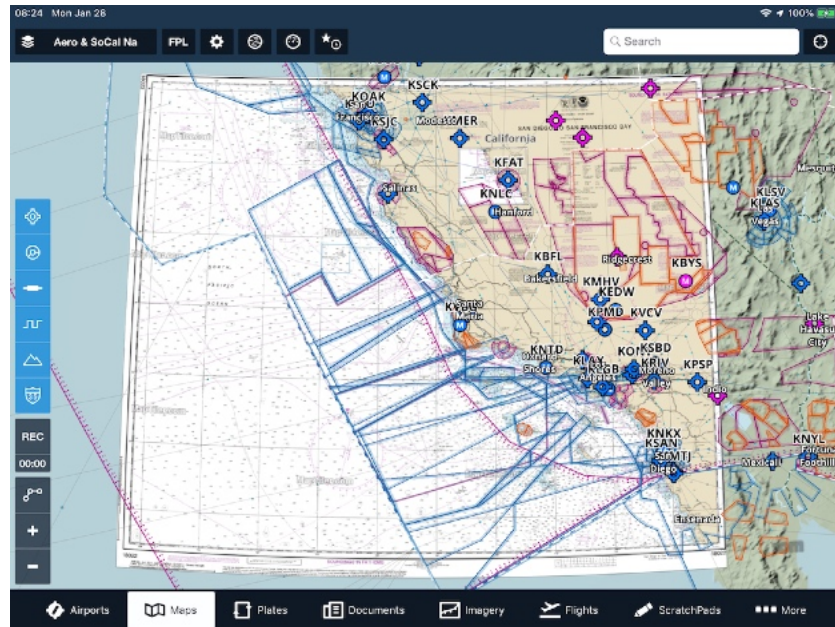

Tap on a Custom Chart in More > Custom Content to see details about it or display it on the Maps page. Visit <https://foreflight.com/support/user-content/> to learn more about Custom Charts and how you can add georeferencing data to your own charts for use in ForeFlight Mobile.

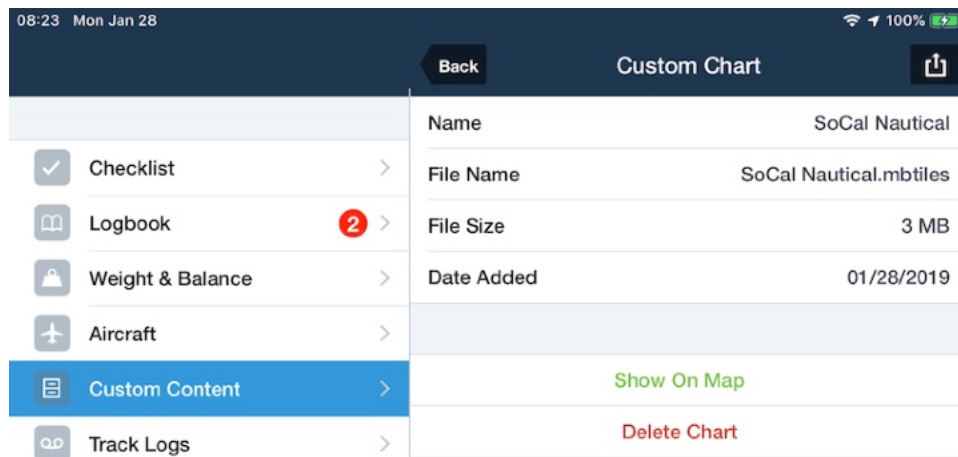

Content Packs

Content Packs are bundles that can include maps, waypoints, procedures, and documents combined into a single folder that is then compressed into a .ZIP file for easy distribution. Content Packs support the following types of custom content:

Plates & Airport Diagrams (BYOP): The “Bring Your Own Plates” feature allows you to import PDF files that you can access in the Plates view or in the Airports view under the Procedures tab. Files imported this way behave the same as procedure plates and airport diagrams downloaded through ForeFlight, although they do not support georeferencing or Plates on Maps.

Map Layers: You can import KML, KMZ, and GeoJSON files to display custom shapes, markers, and labels on the map, and can import MBTiles and [FBTiles](#) files to display georeferenced charts and maps.

Navigation Data: You can associate PDF and HTML documents with specific waypoints to allow them to be accessed directly from the map. You can import these types of “rich” waypoints using either KML or CSV files.

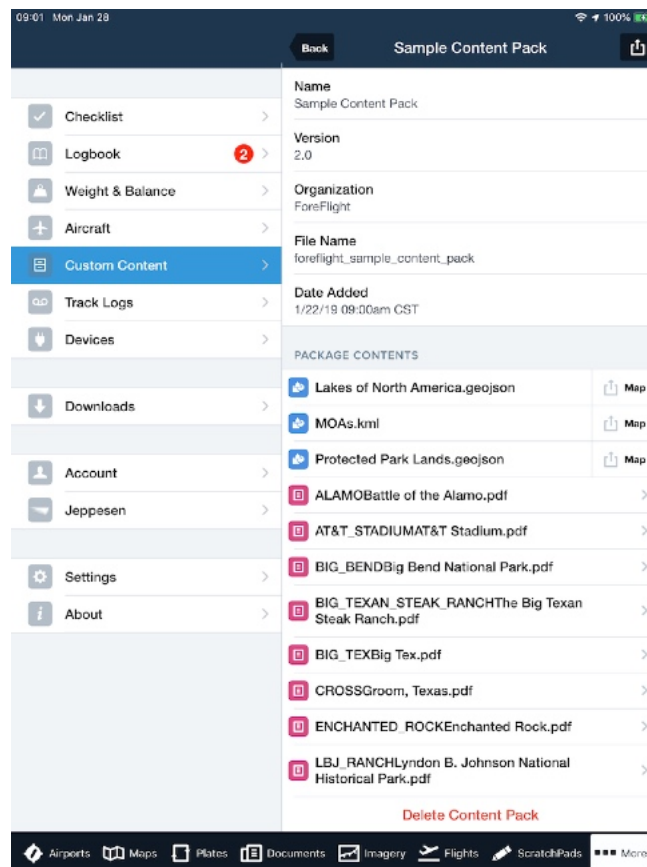

Content Pack Structure

A Content Pack consists of a top-level folder that can contain 1-3 sub-folders, depending on the type(s) of custom content being included in the Content Pack, and optionally a manifest.json file providing additional information about the Content Pack.

The sub-folders are:

- ❖ **byop** : contains procedure plates, airport diagrams, and other PDF files related to specific airports.
- ❖ **layers** : contains georeferenced charts and vector data layers.
- ❖ **navdata** : contains waypoint files and any associated PDF documents.

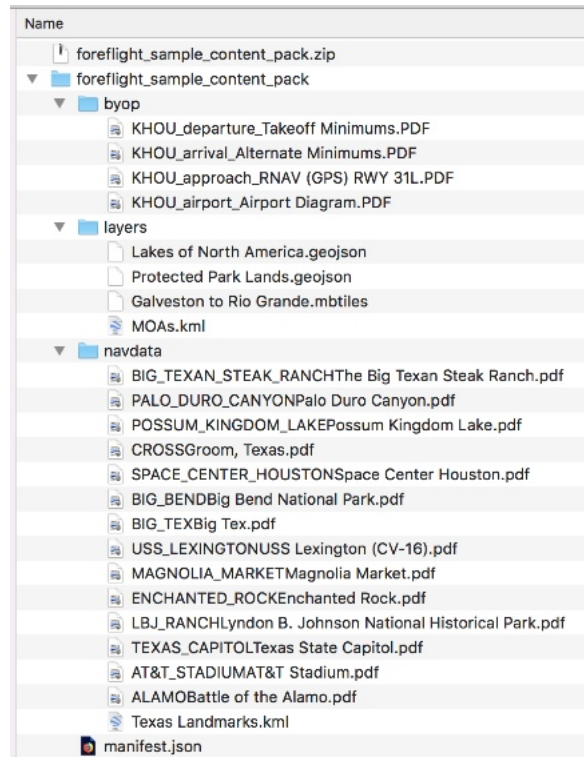

The name of the top-level folder defines how the Content Pack name will appear in the app. **IMPORTANT:** The top-level folder should not have any spaces between words in the folder name; instead use "-", "_", or another symbol between words.

Example Content Pack naming & structure

<i>Content pack folder name:</i>	west_coast-pack1
<i>sub-folder:</i>	byop
<i>sub-folder:</i>	layers
<i>manifest file:</i>	manifest.json

byop folder:

The “byop” folder contains PDF files that will appear in the Airport view’s Procedure tab as well as the Plates view. These files do not currently support georeferencing. BYOP files imported via Content Packs use the same naming conventions as standalone BYOP files, see: <https://foreflight.com/support/byop/> for more details. BYOP filenames use the following format:

“airportID_procedureType_procedureName.PDF”

E.g.: "KHOU_Approach_RNAV (GPS) RWY 31L.PDF"

Omitting the procedure type will cause the file to be placed in the "Other" category in the Airport Procedures tab.

layers folder:

The "layers" folder contains map layers files in the following types: MBtiles (for georeferenced charts), FBtiles, KML, KMZ, and GeoJSON. MBtiles and FBtiles charts appear at the bottom of the left column in the Maps layer selector, and KML, KMZ, and GeoJSON files appear in the bottom of the right column. NOTE: KML files in ForeFlight Mobile currently support a limited subset of the all possible KML data types. See <https://foreflight.com/support/content-packs/> for full details.

navdata folder:

The "navdata" folder contains waypoint files as well as PDF and HTML documents that either "stand alone" or that can be associated with and accessed from individual waypoints on the map. Waypoint files can be either KML, KMZ, or CSV, but only KML and KMZ files allow custom waypoint styling.

The document files can be either PDFs or TXT files containing HTML code - files using the .html extension are not currently supported. To associate a document with a waypoint, the document filename must use the following format:

"WAYPOINT_NAMEDocument Name.PDF"

The document's filename must start with the exact name of the waypoint, including case and any underscores, followed immediately by the name of the document as it will appear in ForeFlight. Each document can only be associated with one waypoint, but you can associate multiple documents with the same waypoint. Content Packs can also contain documents that aren't associated with any waypoint, in which case they will only be accessible from the Content Pack's detail view.

manifest.json file:

The manifest.json file provides information about the Content Pack itself to help identify it and distinguish it from previous versions of the same pack. The manifest is a simple JSON file that includes the pack's full and abbreviated names, version number, and the organization name. If you don't include a manifest then ForeFlight will use the Content Pack's file name and your account email by default.

The manifest.json file has the following structure:

```
{  
    "name": "West Coast Pack 1",  
    "abbreviation": "WCP.V2",  
    "version": 2.0,  
    "organizationName": "ForeFlight"  
}
```

You can use a plain text editor to create or modify the manifest file on your computer (make sure the file has the extension .json), or use an online resource like <https://jsoneditoronline.org/> to create and download the JSON file.

Once the Content Pack contents are complete, compress the Content Pack folder into a .ZIP file.

Importing a Content Pack

Content Packs can be imported into ForeFlight via AirDrop, email, iTunes, online hyperlinks, and via a Cloud Document account linked to your ForeFlight account (requires a Pro plan or above). See <https://foreflight.com/support/content-packs/> for full details about each method.

Track Logs

The Track Logs view is where you can view and edit details about recorded Track Logs and export them to your logbook, share them via email, or open them in other apps, such as Google Earth and CloudAhoy.

See [Track Logs](#) for more information.

Passenger

ForeFlight Passenger is a free companion app to ForeFlight Mobile that helps answer your passengers' age old question, "Are we there yet?". The Passenger app is downloaded separately from the Apple App Store.

Passenger mode is available in ForeFlight Mobile version 11.2 and later. To activate Passenger mode, first make sure that your iPad's or iPhone's Wi-Fi is ON, and that Wi-Fi is ON in the device(s) being used for Passenger. **NOTE:** Your device does not need to be connected to the same Wi-Fi network as the Passenger device(s). And the link from ForeFlight Mobile to Passenger will work even if neither device is connected to a specific Wi-Fi network, as long as Wi-Fi is ON in each device.

In ForeFlight Mobile, tap More > Passenger, then tap "Enable & Start." ForeFlight Mobile will automatically begin broadcasting the active route to any copies of Passenger. If multiple copies of ForeFlight Mobile have enabled Passenger mode, individual copies of Passenger can select from which pilot they receive updates, in the Passenger Settings (see below).

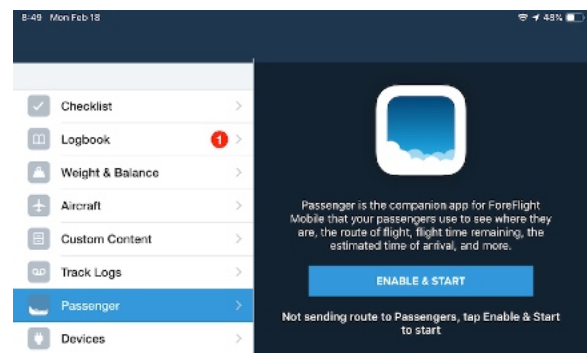

In-flight, any route changes you make in ForeFlight Mobile will automatically be sent to the device(s) running Passenger.

To stop sending route updates to Passenger, tap the red "Disable Passenger Mode" button.

Your passengers' devices running Passenger display a simplified Map showing the route, and use their built-in GPS to calculate the estimated time remaining and Estimated Time of Arrival (ETA), along with speed and track.

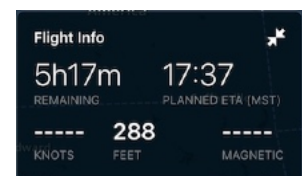

In Passenger, tap the “Auto Center” button to center the map on your current position, then tap the “North up/Track up” button to orient the map with “North up”, eg North is towards the top of the screen, or “Track up” eg: your direction of travel is towards the top of the screen.



In Passenger, touch a single finger on the screen and drag to reposition the map. NOTE: After about 30 seconds without touching the map the Auto Center reactivates automatically. Touch two fingers on the screen and pinch apart to zoom-in, and pinch together to zoom-out.

In Passenger, tap the Gear button (lower right) then tap “Pilots >” to see from which pilot’s device Passenger is receiving updates. If more than one Pilot is available, switch between Pilots by tapping the desired Pilot.

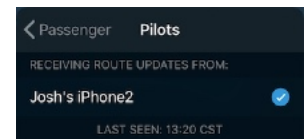
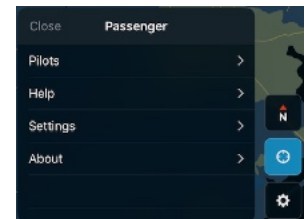

Tap “Settings >” to adjust whether the Passenger device can sleep, or to change the Speed Units (Knots, MPH, or KPH).

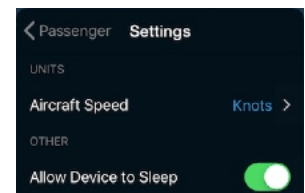

Troubleshooting Passenger

If a Passenger device is not receiving a good GPS signal, a pop-up will appear suggesting that the device be moved closer to a window, or connect to a remote GPS such as a Sentry or Stratus, or a compatible MFi Bluetooth GPS such as a Bad Elf Pro.

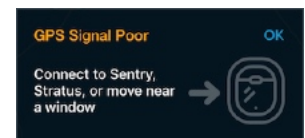

If the Passenger device Wi-Fi is OFF, a pop-up will appear reminding to turn Wi-Fi ON. Route updates cannot be sent to the Passenger device if Wi-Fi is OFF.

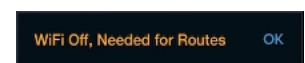

Devices

The Devices view shows any connected devices explicitly supported by ForeFlight. The box for Sentry or other ADS-B receivers, Garmin Connex, and Flight Simulator data connections can be tapped for additional information.

The box for Bluetooth GPSs like the Bad Elf Pro, DUAL, and Garmin GLO indicates that the GPS is connected, but no additional information about the GPS, such as # of satellites or battery % is available. For that information, use the helper app provided by the GPS manufacturer.

Location Disabled / Troubleshooting GPS position issues

Check the following if your GPS position does not show in ForeFlight Mobile or if the "Location Disabled" popup displays:

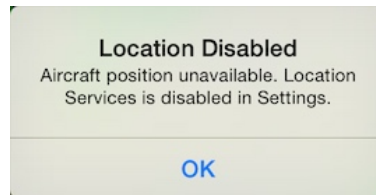

Open Apple Settings, tap **Privacy**, then **Location Services**; or open Apple Settings, scroll down on the left to the list of apps, and tap ForeFlight.



Confirm that Location Services are ON, and the setting for ForeFlight is **Always**.

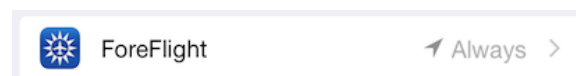

The recommended setting for ForeFlight is “**Always**” because this allows the app to function as designed if the iPad or iPhone is slept or ForeFlight Mobile is put into the background (eg: so track logs can continue to record). If you choose “While Using the App” there may be a delay updating your position after the app is reopened.

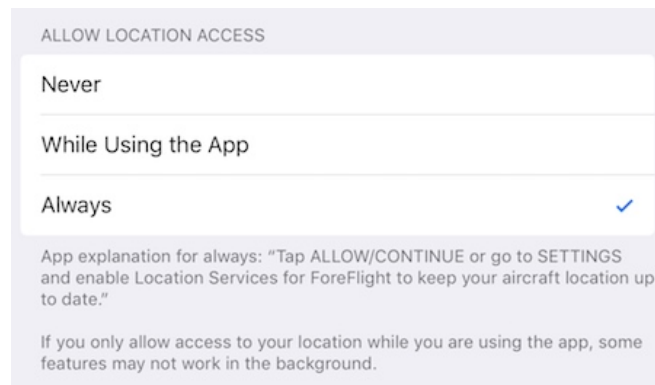

Then open ForeFlight Mobile, tap **More**, then **Settings**. Confirm that Enable Ownship is set to: **Always**.

If these steps do not resolve the issue, contact the ForeFlight Pilot Support Team at team@foreflight.com for assistance.

Account

About the Design

The *Account* view shows the status of your ForeFlight subscription and allows you to proceed to <https://www.foreflight.com/pricing> to upgrade or renew an existing subscription, or to purchase a new subscription.

If you're setting up a new device or retiring an old one, use *Account* to sign in and out of your ForeFlight account.

Viewing your Active Subscription

The table at the top of *Account* shows the status of your account. If you're a trial user, it shows the day you started using the app and when your trial will expire. If you've already purchased a subscription, it shows the day you placed your order and when you need to renew.

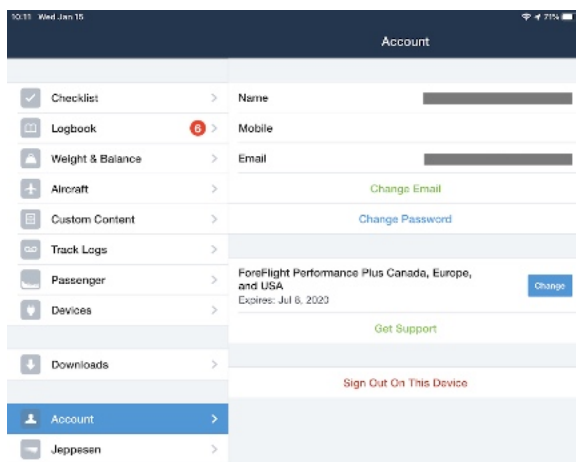

Your Name and Account Email address

Update Account Email address, or change password

Current Plan & Expiration Date Upgrade, renew, or add a region at www.foreflight.com/pricing

ForeFlight Account Sign-Out

A valid subscription is required to continue using the app once the trial expires.

If your expiration date is not correct, then you need to [sign in to your ForeFlight account](#) (see below). Apple does not provide us a consistent method to automatically detect when you start using a new device, so ForeFlight Mobile won't recognize your subscription until you sign in. Also, subscription information can be lost in certain upgrade, backup and restore operations of the device or application, making it necessary to sign in.

Purchasing or Renewing a ForeFlight Subscription

You can purchase a ForeFlight subscription inside the app or on our website, but purchasing through our website offers certain benefits like flexible plan and region options, currency selection, auto-renew for your account, and discounted pricing if you choose to upgrade or renew before your subscription expires. To purchase or renew a subscription on our website, visit [foreflight.com/pricing](https://www.foreflight.com/pricing) to see the available subscription plan options for individual accounts (click "For Businesses" to see plans for multi-pilot accounts). Use the currency selector to view prices in U.S. Dollars, Canadian Dollars, British Pounds, or Euros.

The screenshot shows the 'Simple Plans & Pricing' page for individual users on the ForeFlight website. The page features a dark blue header with the ForeFlight logo and navigation links for PRODUCTS, SOLUTIONS, SUPPORT, and COMPANY. A 'LOGIN' button is in the top right. Below the header, there are tabs for 'FOR INDIVIDUALS' (selected) and 'FOR BUSINESSES'. A currency selector is set to '\$ US Dollars'. Three subscription plans are displayed in white cards with blue accents:

- BASIC PLUS**: \$99.99*/yr. Includes 'All the Essentials for VFR and IFR Flying' such as flight planning, international plan filing, graphical briefing, and weather data.
- PRO PLUS**: \$199.99*/yr. Includes 'Added Safety and Situational Awareness' features like geo-referenced charts, synthetic vision, and hazard advisor.
- PERFORMANCE PLUS**: \$299.99*/yr. Includes 'Advanced Flight Planning' features like detailed aircraft profiles, next-generation planning engine, and optimized routes.

Each plan card has a 'BUY' button, a list of features with icons, and a note that one geographic region is included (United States, Canada, or Europe) with an additional region for \$100. A 'Help' button is located at the bottom right of the page.

Scroll down to see a detailed feature comparison table that lays out the differences between the plan levels. Click the feature names on the left to see more details about each of them.

FEATURES	BASIC PLUS	PRO PLUS	PERFORMANCE PLUS
Global Aeronautical Maps >	✓	✓	✓
Flight Planning >	✓	✓	✓
File & Brief >	✓	✓	✓
Aviation Weather >	✓	✓	✓
VFR & IFR Charts >	✓	✓	✓
Jeppesen VFR Procedures > NEW	✓	✓	✓
Optional Data Packages > NEW	ADD-ON	ADD-ON	ADD-ON
ForeFlight Taxi Charts >	✓	✓	✓
Airport & FBO Information > <small>Neatly organized global airport directory includes over 25,000 locations. View frequencies, procedures, runways, weather, and more. Comprehensive FBO Directory provides services, amenities, fuel prices, photos, contact information, and more.</small>	✓	✓	✓
Global Navigation Data >	✓	✓	✓ Help

Click the Buy button for one of the subscription plans to advance to the Buy page, or access the page directly at foreflight.com/buy. Enter your email address at the top of the page, then scroll down to review the flexible plan options for your subscription. The currency selector is also available here so you can see what each add-on costs in your selected currency.

NOTE: Once you purchase a subscription in a given currency, your account is tied to that currency, and any upgrades or renewals you purchase in the future must be made using the same currency. If you need to change your account to use one of the other available currencies, please email team@foreflight.com.

All individual subscription plans include one geographic region by default, providing charts, data, and documents for that region. If you want

SELECT YOUR FOREFLIGHT REGION(S)

- United States (included)**
 - FAA VFR Charts, IFR High and Low Charts, Plates, Taxi Charts.

- Canada (\$100/yr)**
 - NAV CANADA VNC Charts, IFR High and Low Charts, Plates, Taxi Charts.

- Europe (\$100/yr)**
 - Jeppesen European VFR Data on the Aeronautical Map, EUROCONTROL AIP Procedures, EUROCONTROL Charts and Documents

Your plan includes one region of your choice. Additional regions may be added.

to access charts and data for additional regions, you can add them for an additional cost using the region selector.

If you want to add Jeppesen IFR chart coverages to your ForeFlight subscription you can click the “OPTIONAL: ADD JEPPESEN CHARTS” header to expand the coverage selector. See [Purchasing Through ForeFlight](#) for more information on adding Jeppesen charts this way.

If you selected the Europe region for your subscription plan, an additional section at the bottom of the page allows you to add optional Europe VFR packages. The National VFR Data packages provide country-specific VFR charts and AIP documents from different national AIP providers, such as DFS for Germany. Below that you can select Jeppesen VFR Procedure Charts (formerly known as “Bottlang”) for all supported countries in Europe or for individual countries. Click the Individual Countries button to see which countries have Jeppesen VFR procedure charts and to select them individually.

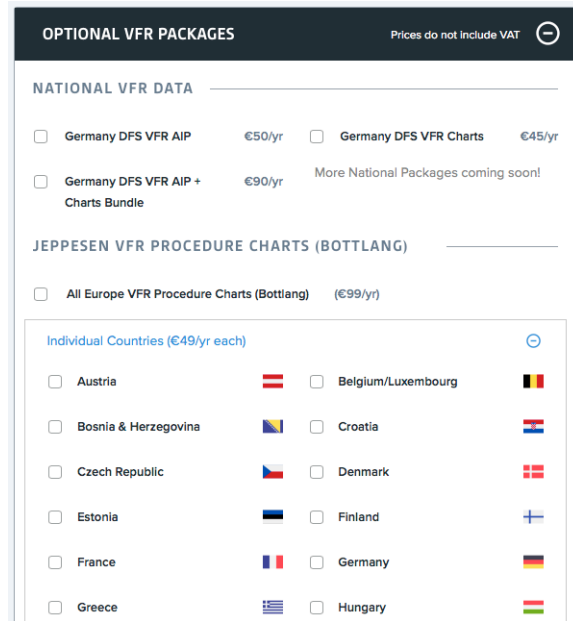

NOTE: It is currently not possible to access Jeppesen VFR procedure charts purchased through ForeFlight and Jeppesen IFR charts from a linked account at the same time. If you have an existing Jeppesen account and want to add Jeppesen VFR procedure charts through ForeFlight, you should contact Jeppesen to refund or cancel your existing IFR coverage and purchase the same coverage through ForeFlight, along with the VFR procedure charts.

Once you are satisfied with your subscription plan options, click Proceed to Payment to access the check out field. You can pay using either a credit card or a PayPal account. Click Purchase This Subscription to finalize the purchase. You’ll then receive a few emails with your purchase receipt, a link to create a password for your new account, and a Welcome email with resources to help you get started with ForeFlight.

NOTE: If you are using an iTunes gift card towards an in-app purchase, make sure you have redeemed the card (eg: deposited its value in your iTunes account) **before** you tap the button in the app to purchase the subscription.

Signing In to your ForeFlight Account

After you purchase a subscription in the app, you are automatically signed in on that iPad or iPhone. When you purchase on our website or want to sign in on a new device, download ForeFlight from the Apple App Store and select “I Have An Account” after opening the app, then sign in with your username and password.

To sign in on a device that already has ForeFlight installed:

- ❖ Tap the **More** tab at the bottom, then “Account” in the left side list.
- ❖ Tap **Sign In**
- ❖ Enter your email address and password and tap **Sign In**.

If you can’t find your password, enter the email address that you originally used to purchase your subscription and tap the **Forgot Password** button. An email will be sent to you with instructions for resetting your password.

Signing Out of your ForeFlight Account

When you’re ready to retire your old iPhone or iPad and won’t be using it anymore, remember to sign out of your ForeFlight Account on that device:

- ❖ Tap the **More** option at the bottom, then “Account” in the left side list
- ❖ Tap **Sign Out On This Device**

This will “unhook” the device from your account. Afterwards, you can delete the app from your device to free up space if you don’t plan to use the app on that device again. Tap-and-hold on the ForeFlight icon until it starts to wiggle, then tap the “X” button displayed on the top-left corner of the icon.

Changing your Password or Email

To change your password or email address inside the app:

- ❖ In the Account Logins table at the bottom, tap *ForeFlight*
- ❖ A screen is displayed with your email address and password. Tap **Change Password** or **Change Email** at the bottom. **NOTE:** Change Email is used to update your existing account’s address. If you need to switch to a different or new account, sign out of your existing account and sign back in to the other account.
- ❖ Follow the on-screen instructions for changing your password or email.

You can also use the ForeFlight Manage website to change your email, password, and manage which devices are associated with your account. ForeFlight Manage is available at: www.foreflight.com/manage.

Removing Devices from your Account

If you are signed in to your ForeFlight account on other devices, they will be shown on the Accounts view under "Also Signed In On." You can remove a device from your account, which is the same as signing out of your account on that device, by tapping the red Remove button and entering your ForeFlight credentials.

ALSO SIGNED IN ON	
Sam's iPhone iPhone 5s (A1433/A1453)	Remove
Sam's iPad iPad mini 3 (Wi-Fi)	Remove

Jeppesen

ForeFlight allows you to download and view Jeppesen terminal and enroute charts in the mobile app, either by linking an existing Jeppesen chart subscription or by adding Jeppesen charts to your ForeFlight subscription with an online purchase at <https://www.foreflight.com/pricing>.

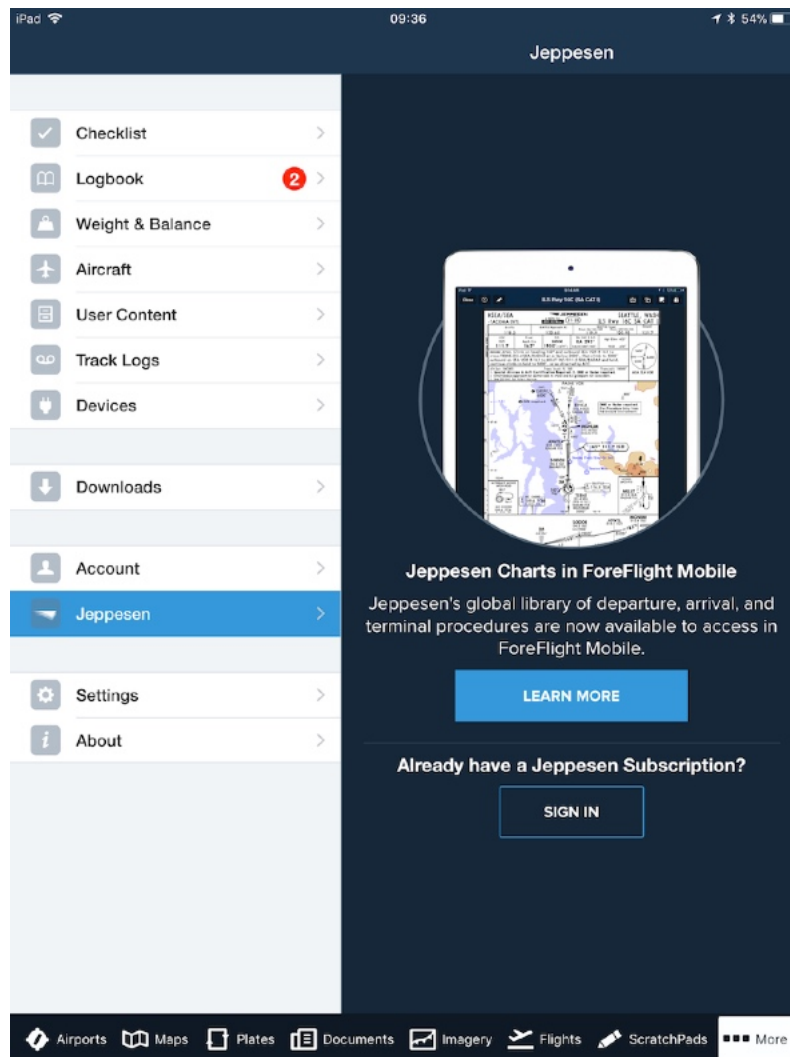

Purchasing Through ForeFlight (single-pilot accounts only)

You can add Jeppesen charts to your ForeFlight subscription in the same way that you would upgrade or renew your subscription. Only single-pilot ForeFlight accounts can add Jeppesen charts this way; if you're the manager of a multi-pilot ForeFlight account and want to add Jeppesen charts, contact Jeppesen by emailing foreflight@jeppesen.com.

Sign into ForeFlight on the web by clicking “Login” in the top-right of [ForeFlight’s homepage](#) and signing into your account. Click the “Account” tab at the bottom of the left-hand navigation bar (the tab will show your first name), and click “Upgrade or Renew my Subscription” next to your subscription name.

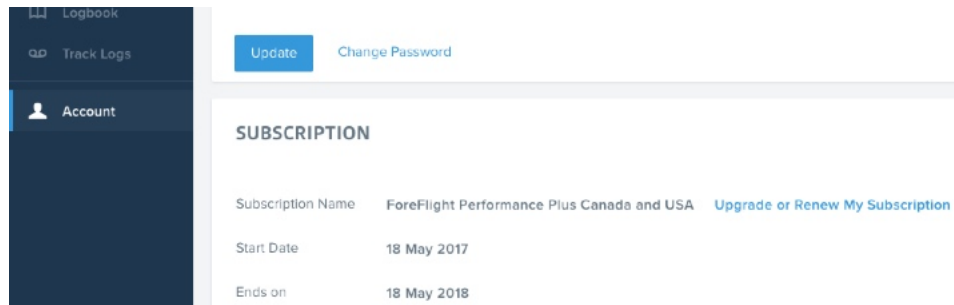

This will take you to ForeFlight’s Buy page where you can select your ForeFlight plan level and selected regions, then scroll down and click the “Add Jeppesen Charts” header to expand the list of Jeppesen coverage options. Select the coverage(s) you want to add, then input your credit card information if it isn’t already on file and click “Purchase This Subscription”. If you’re renewing an existing subscription, the remaining time on your account will be converted to a dollar amount and applied to the purchase as credit; this number appears in green on the right, above the total amount.

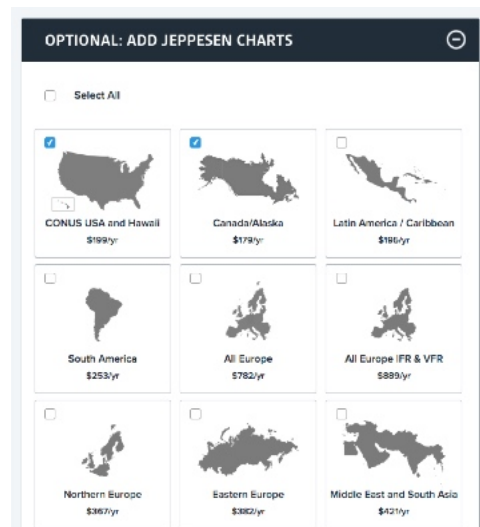

After adding Jeppesen charts to your subscription, the purchase will need to be verified and approved by Jeppesen before terminal charts become available in ForeFlight. This process can take up to 15 minutes, during which a notice will appear on the More > Account view letting you know that your order is being processed. Once processing is complete, two new items will become available for download in the Download view: the global enroute charts and the terminal charts for your coverage.

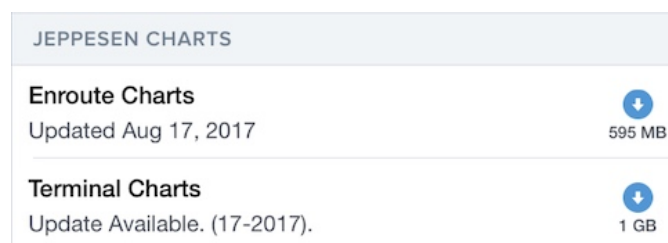

Once you purchase Jeppesen charts through ForeFlight, the Sign In page on the More > Jeppesen tab will go away, and the page will show your Jeppesen coverages.

Linking an Existing Jeppesen Account in ForeFlight Mobile

If you already have a Jeppesen chart subscription, you can sign into your Jeppesen account in ForeFlight Mobile to access the charts. You can also sign in to your Jeppesen account using ForeFlight’s web application, as explained in the next section.

Go to More > Jeppesen and tap Sign In, then enter your Jeppesen username and password and sign in. You can then select the Jeppesen coverage that you want to activate in ForeFlight. You can only activate one coverage at a time, and you can only activate a coverage if it has “seats” available. The coverage list shows the full name of each coverage, the serial number, the aircraft tail number associated with the coverage (if you specified one when setting up the coverage) and the number of seats available. Tap “Install” to activate a coverage on your device.

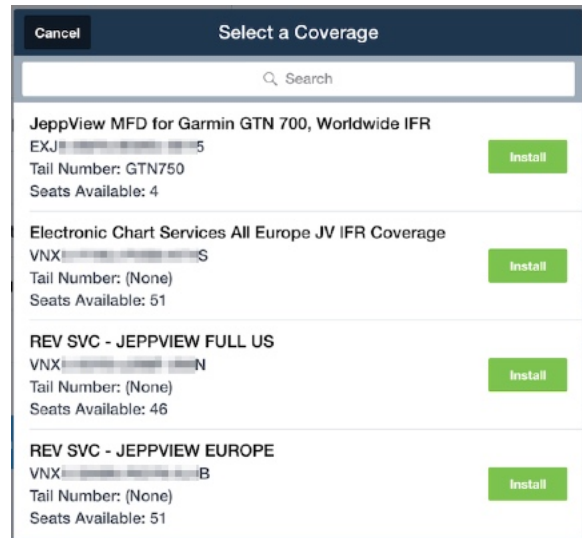

After activating a coverage, ForeFlight will prompt you to begin downloading it. You can tap “Begin Download” to start the download, or tap “Dismiss” to postpone the download until later - this may be preferable if you aren’t on Wi-Fi or don’t have time to complete the download, which can be very large depending on your coverage.

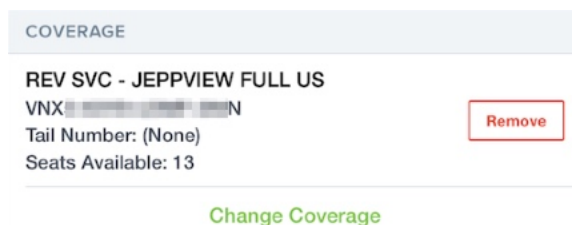
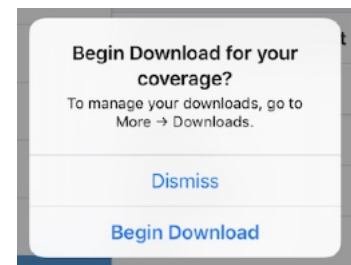

Tap “Remove” to uninstall the current coverage from your device, and tap “Change Coverage” to uninstall the current coverage and activate a different one. Removing the current coverage from your device will also immediately remove the charts you’ve downloaded for that coverage.

Signing into a Jeppesen account on one device will allow you to access the account on all of your other signed-in ForeFlight devices without having to sign in again. If you sign out of your Jeppesen account on any device it will also sign you out of the account on all of your other ForeFlight devices and remove the installed coverages and charts from those devices.

Linking an Existing Jeppesen Account in ForeFlight on the Web

Account managers of multi-pilot ForeFlight accounts can sign in to a Jeppesen account to allow the users on their account to activate coverages and download charts. Account managers can sign in to the Jeppesen account in the mobile app as described above, or on ForeFlight’s web application, which provides management capabilities over the Jeppesen coverages installed by the account’s users.

Sign into ForeFlight on the web by clicking “Login” in the top-right of [ForeFlight’s homepage](#) and signing into your account. Click the “Account” tab at the bottom of the left-hand navigation bar (the tab will show your first name), and click the Jeppesen tab at the top. Click Sign In and enter your Jeppesen username and password. After signing in you can see information about your Jeppesen subscription, coverages, and users who have installed coverages on their devices.

Once the account manager signs into a Jeppesen account, either online or in the mobile app, all of the account’s users will automatically be signed in to the same Jeppesen account on their devices. They can then add coverages included in the account. The account manager can see which users have installed which coverages under the “Installed” section of the Jeppesen tab on the web.

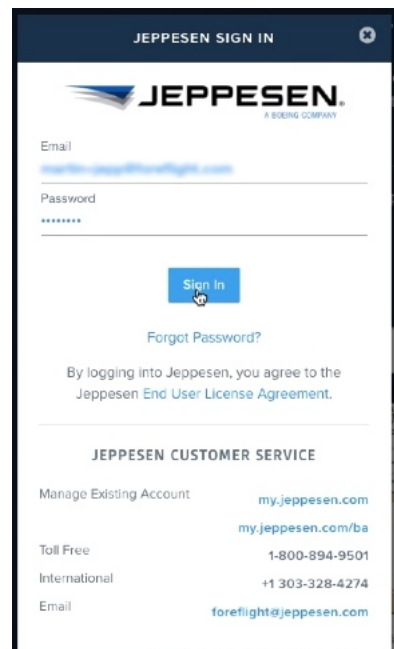

INSTALLED					
Q Search					
DEVICE NAME	PILOT NAME	COVERAGE	SERIAL	TAIL NUMBER	
Sam Taylor's iPad	[REDACTED]	Electronic Chart Services ForeFlight Mobile Single Seat Initial, Electronic Chart Services ForeFlight Mobile Atlantic IFR Coverage, Electronic Chart Services ForeFlight Mobile Europe VFR Coverage	[REDACTED]	N/A	Deactivate

The account manager can also remove coverages from users' devices by clicking "Deactivate" next to the device's name. This will uninstall the coverage and downloaded charts from that user's device, but it will not remove the user from the Jeppesen account itself, allowing the user to immediately install another coverage.

Multi-pilot account users cannot sign in to a Jeppesen account on their own - only the account manager can sign in to a Jeppesen account. Similarly, users cannot sign out of a Jeppesen account on their devices, other than by signing out of their ForeFlight account entirely, but users are free to install and uninstall any coverages provided with the Jeppesen account. If the account manager signs out of the Jeppesen account, all users will also be signed out of the account and have their coverages and downloaded charts removed.

Using Jeppesen Terminal Charts in ForeFlight

After you download Jeppesen terminal charts in ForeFlight they will become available in all the places where you can normally access charts, including the Plates view, Airports view, and Maps view. When viewing a list of procedures at an airport for which you have Jeppesen charts, the Jeppesen terminal charts will appear at the top of the list, while the FAA charts are still accessible further down the list if you want to view them. Jeppesen charts will also become the new defaults in scenarios where ForeFlight will display a terminal chart automatically, such as when showing an airport's taxi diagram by tapping on its bubble in the Route Editor, adding an approach plate using Procedure Advisor, and displaying an airport's taxi diagram automatically upon landing at it. Note: A Pro, Pro Plus, or Performance Plus subscription plan is required to view your position on plates and taxi diagrams, and to overlay plates on the Maps view. If you add Jeppesen terminal charts to a Basic Plus plan, they will only be viewable in the Plates view.

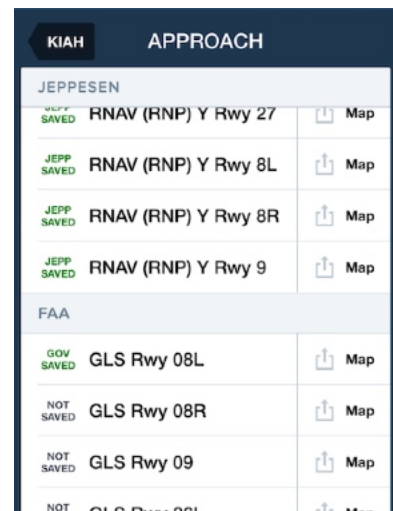

Adding Jeppesen coverages in ForeFlight will also allow you to download Jeppesen's airway manuals for all the coverages you have access to. After signing in to your Jeppesen account or adding Jeppesen charts to your ForeFlight subscription, a new "Jeppesen" tab will appear in the Documents Drive containing the airway manuals available for download.

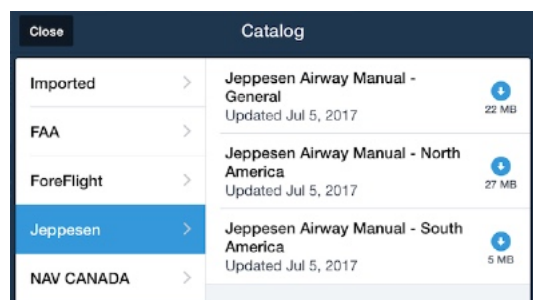

Using Jeppesen Enroute Charts in ForeFlight

Purchasing Jeppesen chart coverage(s) through ForeFlight's website or linking an existing Jeppesen subscription will allow you to download Jeppesen's full set of global VFR and IFR enroute charts, no matter what coverage you have for the terminal charts. The enroute charts will be available in the Maps view layer selector, at the top just under the Aeronautical layer.

Note: Jeppesen enroute charts are not available when using the following devices: iPad Mini 1, iPad 2, iPad 3, and iPhone 5 and earlier.

Like ForeFlight's Aeronautical layer, the Jeppesen enroute charts are data-driven, dynamic, and customizable. Changing the camera position or zoom level of the map will cause the charts to change what is shown and will reposition labels to optimize visibility. Also like the Aeronautical layer, Jeppesen's enroute charts support always-up labels, allowing labels and markers on the map to rotate during track-up flying.

The global enroute charts are also extremely efficient with storage space, with worldwide coverage taking up just over 1GB of disk space after they charts have been downloaded and decompressed.

Enabling any of the Jeppesen enroute chart layers will add new settings to the Map Settings menu, allowing you to change what data is shown for that chart layer. The selections you make only apply to the currently-selected layer, so you can mix and match the map settings for each Jeppesen enroute chart type to optimize the appearance of each one.

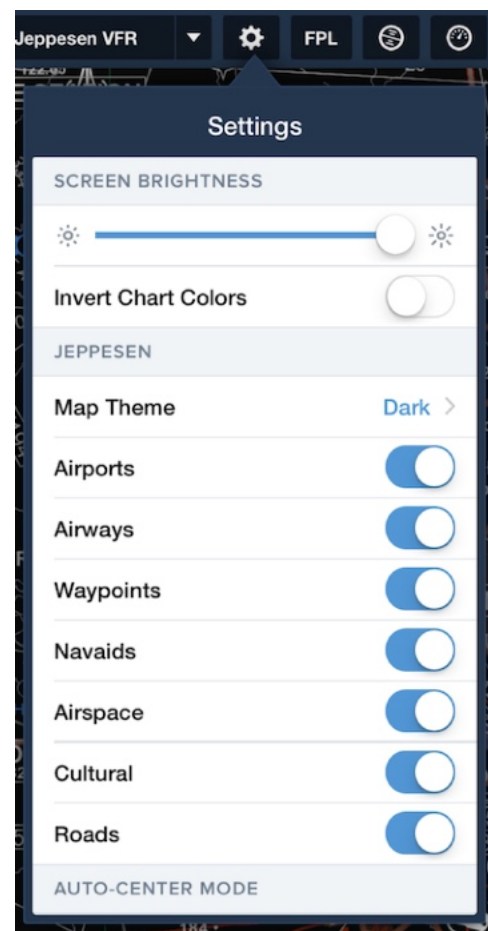
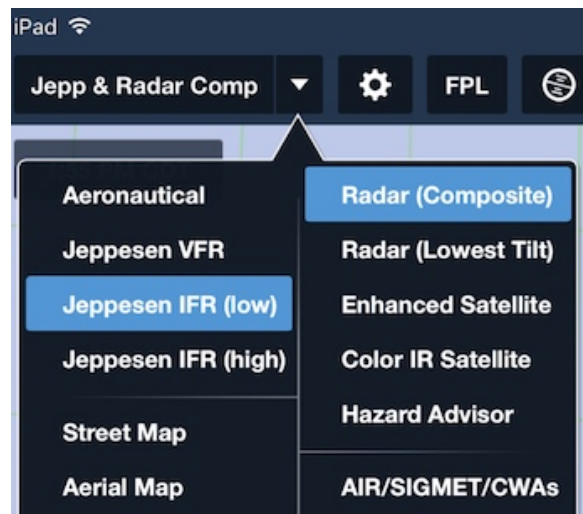

The following table lists the map settings available with each Jeppesen enroute chart type and what they do.

	Jeppesen VFR	Jeppesen IFR (low)	Jeppesen IFR (high)
Map Theme	Choose between a Light and Dark map theme. The Dark Theme inverts black and white while preserving other colors, similar to ForeFlight's Invert Chart Colors switch. Unlike the other settings listed here, this setting is preserved between different chart types.		
Airports	Show or hide airport markers and labels, including private airports and helipads. Zooming into large airports will reveal their runway configuration.	Show or hide airport markers and labels, not including private airports and helipads. Zooming into large airports will reveal their runway configuration.	Show or hide airport markers and labels, not including private airports and helipads. Zooming into large airports will reveal their runway configuration.
Airways	Show or hide VFR corridors and IFR low airways, including labels, MEAs, MOCAs, and radials from nav aids.	Show or hide IFR low airways, including labels, MEAs, MOCAs, and radials from nav aids.	Show or hide IFR high airways, including labels, altitudes and radials from nav aids.
Waypoints	Show or hide VFR waypoints and IFR low waypoints.	Show or hide IFR low waypoints.	Show or hide IFR high waypoints.
Nav aids	Show or hide navigation aids and labels, including NDBs, VOR-TACANs, and VOR-DMEs.	Show or hide navigation aids and labels, including NDBs, VOR-TACANs, and VOR-DMEs.	Show or hide navigation aids and labels, including VOR-TACANs and VOR-DMEs.

Airspace	Show or hide airspace boundaries and labels, including controlled airspace, Mode C, MOAs, SUAs, ADIZ, FIRs, and ARTCC radio frequencies.	Show or hide airspace boundaries and labels, including controlled airspace, MOAs, SUAs, ADIZ, FIRs, and ARTCC radio frequencies.	Show or hide airspace boundaries and labels, including SUAs, ADIZ, FIRs, and ARTCC radio frequencies.
Cultural	Show or hide cultural information and labels, including spot elevations, urban areas, railway lines, parachute jumping areas and magnetic longitude lines.	N/A	N/A
Roads	Show or hide major highways, roads, and streets.	N/A	N/A

Note: enable the Jeppesen VFR theme in More > Jeppesen by turning the “Display VFR Theme” switch ON.

Settings

ForeFlight Mobile supports a variety of settings to let you customize how you like to use and view your data. Most settings are found in the *More* view, but some are also available on their respective pages, e.g. Maps view settings can be found in the Maps Settings menu.

All settings will be reset to their default values if you uninstall ForeFlight Mobile.

To quickly find a setting, start typing the name of the setting in the “Filter” box at the top of the Settings page:

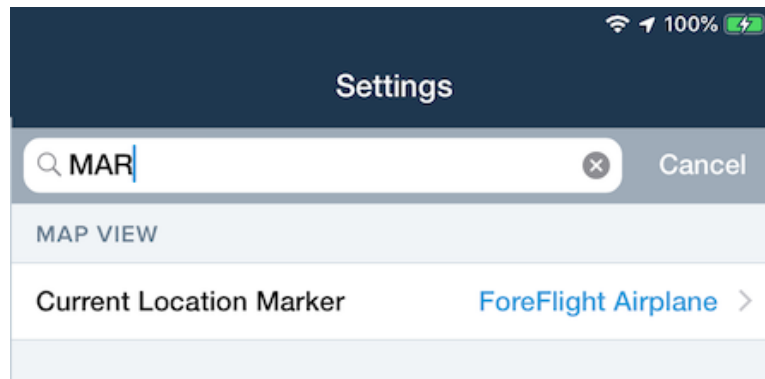

❖ **Brightness Slider** - integrates with the iPad’s brightness slider, but allows for additional dimming if the lowest setting of the iPad’s slider is not dark enough.

App Theme

❖ **App Theme** - Choose “Light” or “Dark” themes, or in iOS 13 or later choose “System” to have ForeFlight follow the sunrise-to-sunset or custom schedule for automatic theme changes in your device’s Settings app; in prior versions of iOS choose “Auto” to have the app automatically switch themes at Sunrise and Sunset based on your device’s local time.

❖ **Light/Dark Settings** - Choose the App Color, Aeronautical Map theme, and whether to Invert the color of Plates, Charts, and Documents.

Airport View

❖ **Show Weather First** - turn *ON* to show the METAR view first when viewing an airport. Turn *off* to see that last-viewed data category first.

Weather View

❖ **Past TAF Translations** - turn *ON* to see expired TAF forecast time periods in the weather view. Turn *OFF* to hide expired TAF forecast periods.

Route View

- ❖ **Airway Decoding** - set to *Bends Only* to filter out airway intersections that do not cause a course change. VORs and NDBs will always be shown in an airway. **NOTE:** When set to “Bends Only” some smart airway labels are not displayed; set to “All Waypoints Shown” to ensure that all smart airway labels are shown.
- ❖ **Airway Entry/Exit** - select Any Waypoint or Radio Nav aids Only for auto routing from the “Routes” button in the Flight Plan Editor.

Map View

- ❖ **Auto Center Mode** - select Track Up, Track Up Forward, or North Up.
- ❖ **Auto Center Deactivate** - select from automatic (auto center mode will turn off the instant you manually pan or zoom the map) or manual (the auto center crosshair button must be pressed to disable auto center mode).
- ❖ **Extended Centerlines** - turn *ON* to see extended runway centerlines for airports in the current route. Centerlines extend 5 NM from runway end.
- ❖ **Distance Rings** - turn *ON* to show 3 concentric rings centered around your aircraft’s location, in the the style selected in Distance Rings Style.
- ❖ **Distance Rings Style** - choose between: Distance-based - Automatic (Distance), which changes the NM scale of the rings as you zoom in and out on the Maps; 5, 10, 25 NM; or 10, 20, 50 NM; or 20, 40, 100 NM; or Time-based - Automatic (Time), which changes the time scale of the rings as you zoom in and out on the map; 5, 10, 30 minutes; or 10, 20, 60 minutes.
- ❖ **Track Vector** - turn *ON* to display a vector in front of your aircraft’s icon.
- ❖ **Track Vector Length** - tap to select the length of the track vector: 15, 30, 45, 60 seconds; 2, 5, 10 minutes; 1/2, 1, 2, 5, 10, 25, 50 Nautical Miles.
- ❖ **Profile Corridor Width** - total width of the profile corridor; obstacles and terrain within the corridor are shown in the Profile view: 1/2, 1, 2, 4, 6, 8, 20 Nautical Miles wide.
- ❖ **Route Labels** - turn *ON* to see labels on route waypoints on Map. When *ON*, these labels will each hide/show to prevent overlapping with each other.
- ❖ **Nav Log Columns** - select columns to display in NavLog on Maps page: Totals Only, Leg only or Both (default).
- ❖ **Current Location Marker** - select the aircraft icon to be used on *Maps* view to show your current location when in motion.

❖ **Hazard Advisor** - select minimum groundspeed for Hazard Advisor layer to be active when it is selected on Maps.

❖ **Hazard Altitudes** - altitudes for the Red and Yellow colors in Hazard Advisor and Profile view. First number is the altitude below the aircraft for the Red color (also includes above current altitude), 2nd number is the altitude below the aircraft for the Yellow color: Normal (100'/1000'); Heli - Normal (50'/300'); Heli - Medium (25'/200'); Heli - Low (25'/100').

❖ **Map Touch Action - No Action:** charts are seamlessly stitched together; **Bring chart to front:** single-tap on a chart to bring it forward, covering any adjacent overlapping charts; **Bring chart to front with legends:** same behavior as **Bring chart to front** but also displays the frontmost chart's legend and borders.

❖ **Cockpit Sharing** - turn *ON* to allow sharing routes between devices running ForeFlight Mobile on the same Wi-Fi network.

❖ **Show Annotations on Map** - turn *ON* to show plate or airport diagram annotations when displaying a Plate or Airport Diagram on the Map.

❖ **Auto-Receive Panel Flight Plans** - turn *ON* to automatically load new routes received from a Garmin Connex connected panel to your Route Editor. Turn *OFF* to receive a notification when a new route is available and manually load it.

❖ **Four-color Radar** - turn *ON* to display radar in a low resolution, four-color scheme that complies with dBZ-to-color mapping standards defined by the Radio Technical Commission for Aeronautics. See [Radar Legends](#) for more information.

❖ **Internet Radar Coverage** - turn *ON* to show the area of available radar coverage while connected to the Internet. Areas with no coverage are shown with hashmarks and "Radar not available".

❖ **Breadcrumbs** - turn *ON* to display a thin green line indicating your recent track. The Breadcrumb trail will display whether or not a Track Log recording is active.

❖ **Breadcrumbs Clear After** - choose the time that Breadcrumbs remain on the screen after landing: 15 min, 30 min, 1 hr, 2 hrs, 4 hrs.

Layer Selector

❖ **Multiple Selections** - turn *ON* to have the drop-down Maps Layer Selector remain open until you tap outside of it on the Maps page. This lets you select and de-select more than one Map layer before the drop-down closes.

Map Annotations

❖ **Show Control** - turn *ON* to show the Annotation button on the Maps page.

❖ **Auto Apple Pencil Drawing** - turn *ON* to cause the Annotation to automatically activate when touching the Maps page with an Apple Pencil.

❖ **Pencil Timeout** - 5, 10, or 20 second timeout to stop Annotation mode after removing the Apple Pencil from the Maps page.

Checklist

❖ **Speak** - Checklists being read aloud include the Challenge, or Challenge & Response.

Plate and Document Views

❖ **Lock Disables Buttons** - turn *ON* to disable all buttons on Plates and Documents views when lock button is bright blue in top toolbar. This will also disable the bottom buttons that are used to change to other views like Airports, Maps, etc.

Traffic

❖ **Hide Distant Traffic** (when connected to any ADS-B receiver) - turn this *ON* to hide traffic more than 15NM from your current GPS location and/or more than 3,500' above or below your current GPS altitude.

Search and Rescue

❖ **SAR Features** - turn *ON* to enable the SAR grid layers and SAR patterns (iPad only). See Search and Rescue Supplement, available in **Documents** > **Drive** > **ForeFlight**. SAR features are accessed via the Procedure Preview.

❖ **SAR Waypoints as Lat/Lon** (iPad only) - turn *ON* to display the waypoint labels in a SAR pattern as Latitude/Longitude, instead of SAR-01, SAR-02, etc...

Downloads

❖ **Automatic Downloads** - turn *ON* to allow the app to automatically download Database and document updates when they become available and when the device is connected to Wi-Fi.

Pack

❖ **Enable Auto-Check** - turn *ON* to have Pack automatically check whether downloads are needed prior to the flight. Turn *OFF* to only activate Pack by tapping the Pack "suitcase" button at the bottom of the Flight Plan Editor.

Track Log

❖ **Enable Start/Stop Control** - turn *ON* to show the Track Log "REC" button and the Track Log timer in the bottom-left of the Maps view. Starting or stopping a

Track Log by tapping the REC button overrides the Track Log auto start/stop functionality, if that setting is enabled.

❖ **Enable Auto Start/Stop** - turn *ON* to automatically record Track Logs without tapping the REC button.

Flights

❖ **New Plan Format** - *Same as Last Filed, ICAO, or FAA/Domestic*: lets you choose the default type of plan that will be created when you tap the "Proceed to File" button on the Flights page. An individual flight plan type can be changed while creating the flight plan on the "Proceed to File" page.

❖ **Briefing Format** - *Graphical (HTML), Graphical (PDF), Classic (Text)*: lets you choose between the U.S.-only Graphical Briefing (delivered in HTML), the international Graphical Briefing (delivered in PDF), and the U.S.-only Classic Text briefing. Regardless of your selection, any flights outside of the US and surrounding countries and territories will result in an international Graphical PDF briefing being generated.

❖ **Enable Fuel Orders** - Performance Plus and Business Performance subscriptions only: turn *ON* to expose the Fuel Order field on Flights, allowing you to create and send fuel orders to your destination FBO before the flight.

❖ **Translate Classic Briefings** - turn *ON* to convert METARs, TAFs, NOTAMs, CWA/AIR/SIGMETs, Synopses, PIREPs, and Area Forecast Reports to plain text in the Classic Briefing.

Taxi Diagram

❖ **Auto Show Taxi** - turn *ON* to automatically switch to the current airport's taxi diagram, when available, upon landing.

❖ **Show Taxi on Map** - turn *ON* to show the automatically-displayed taxi diagram overlaid on the Maps page; turn *OFF* to show on the Plates page.

Preferences

❖ **Alerts** - adjust settings related to in-app alerts. See [Alerts](#) for more information about each alert.

❖ **Speak All Alerts** - turn *ON* to receive audio alerts via your device's speaker or a connected headset for all active alerts in ForeFlight. When toggled *ON* a confirmation message is played; use the iPad/iPhone volume buttons to adjust volume. **NOTE:** TFR and Traffic alerts will not play audio when ForeFlight detects that you are below 250' AGL, even if Speak All Alerts is enabled.

General

- ❖ **500' AGL Alerts** - turn *ON* to receive an alert when your aircraft descends past 500' AGL.
- ❖ **Cabin Altitude Alerts** (requires iPad/iPhone or external device equipped with barometric sensor) - turn *ON* to receive alerts when your aircraft passes 12,000' MSL and 25,000' MSL.
- ❖ **Runway Proximity Alerts** - turn *ON* to receive alerts when nearing or entering a runway.
- ❖ **Sink Rate Alerts** - turn *ON* to receive an alert when your descending vertical speed becomes excessive (-4,000' per minute above 2,500' AGL, -3,000' per minute at 2,500' AGL, down to -1,500' per minute at 500' AGL).
- ❖ **Terrain/Obstacle Alerts** - (requires Pro Plus, Performance Plus, Business Pro, or Business Performance subscription) turn *ON* to show app-wide audio and visual alerts of proximity to obstacles and terrain.
- ❖ **Traffic Alerts** - turn *ON* to receive an alert when traffic is within 1.8 NM and +/- 1,200' GPS altitude of your aircraft's current position. **NOTE:** Traffic audio alerts are only issued when ADS-B Out is detected in your aircraft.

Devices

- ❖ **Device Disconnect** - turn *ON* to receive an alert when a connected Wi-Fi or Bluetooth device disconnects from ForeFlight abruptly.
- ❖ **Flight Plan Auto Update** - turn *ON* to receive an alert when a connected panel device automatically loads a flight plan into ForeFlight's Route Editor. Requires that the "**Auto-Receive Panel Flight Plans**" settings is enabled.
- ❖ **Connected Portable Device Battery Low** - turn *ON* to receive an alert if the battery in a supported connected Portable device (such as a Sentry, or Stratus) reaches 20%.

Route-Based

- ❖ **Destination WX Frequency Alerts** - turn *ON* to receive a callout with your destination airport's weather frequency as you near the airport.

TFRs

- ❖ **TFR Alerts** - turn *ON* to receive alerts when you are approaching or near a TFR.
- ❖ **Include DC SFRA/FRZ** - turn *OFF* to prevent ForeFlight from issuing TFR alerts for Washington DC's Special Flight Rules Area and Flight Restricted

Zone. Other TFRs within the SFRA/FRZ (e.g. stadium TFRs) will still trigger alerts when this setting is *OFF* - only the SFRA/FRZ are affected by it. Pilots are encouraged to leave this setting *ON* unless they regularly fly through the SFRA/FRZ.

❖ **Altitude Buffer** - height in feet added above and below TFRs that determines whether an alert is displayed based on your altitude relative to the TFR. For example, approaching a TFR whose top is 4,000' below your current altitude will trigger an alert if the altitude buffer is set to 5,000', but will not trigger an alert if the altitude buffer is set to a smaller height. Available buffers are 500', 1,000', 2,000', and 5,000'.

❖ **Units/Time** - menu containing the following settings:

❖ **Show Local Times** - turn *ON* to see times in your device's local time zone. Arrival times are shown in the destination airport's time zone. Turn *OFF* to see all times in Zulu time.

❖ **Wind Speed** - select preferred units.

❖ **Pressure** - select preferred units.

❖ **Temperature** - select preferred units.

❖ **Visibility** - select preferred units.

❖ **Coordinates** - select preferred units for viewing coordinates.

• **DD.dd^o** - degrees and hundredths of degrees.

• **DD^oMM.mm** - degrees, minutes, and hundredths of minutes.

• **DD^oMM'SS"** - degrees, minutes, and seconds.

• **MGRS 6-/8-/10-digit** - Military Grid Reference System with three precision levels (more digits equates to greater precision).

❖ **Aircraft Speed** - select preferred units for airspeed and groundspeed.

❖ **Distance** - select preferred units for distance.

❖ **Runway Length** - select preferred units for runway lengths.

❖ **Allow Device to Sleep** - turn *ON* to allow your device to sleep while running ForeFlight Mobile, including when on Plates view or when downloading data. Turn *OFF* to ensure that the iPad will not enter sleep mode while ForeFlight Mobile is running in the foreground, even if your iPad is set to usually sleep after a certain period of inactivity.

- ❖ **Automatic Clock Check** - turn *ON* to automatically verify that your iPad's system time is set correctly. If it is found to be incorrect, you will get an alert. Proper system time is important for many features in the app.
- ❖ **Confirm Before Dial** (iPhone only) - turn *ON* to display a popup when you tap on a phone number so you can confirm that you want to call the number.
- ❖ **Enable Ownship** - **ALWAYS**: shows your aircraft position on charts, and with ForeFlight Mobile Pro, on approach plates and airport diagrams; **NEVER**: your aircraft position is not shown on any chart or plate. This is required for certain operators; **LIMITED**: with ForeFlight Mobile Pro, shows your aircraft position on the airport diagram when your speed is under 80 knots; above 80 knots, or when GPS location accuracy degrades below the requirements in AC-120-76C, the aircraft position will not be shown.
- ❖ **Show Heliports** - turn *ON* to view heliports in nearby airports lists. You can always search for heliports (and use them in routes) regardless of this setting.
- ❖ **Show Private Airports** - turn *ON* to see private airports in nearby airports lists. Private Airports include any airport not open to the public, including Military airports.
- ❖ **Start on Last Screen** - turn *OFF* to start on the *Airports* view on next launch. This can help if one view is causing the application to quit immediately after launch.
- ❖ **Synchronize User Data** - turn *ON* to synchronize user data automatically between devices via the cloud. See [Sync](#) for details.
- ❖ **Enable Diagnostic Logs** - turn *ON* to record diagnostic information as you download chart data. This information can then be sent to the ForeFlight Pilot Support Team to help troubleshoot problems you may be having downloading data.
- ❖ **Performance Logging Level** - used to diagnose issues with app performance. Do not set this to anything other than zero unless instructed by a ForeFlight support team member as it may negatively impact healthy app performance.

About

The *About* view provides more information about ForeFlight, LLC as well as version information (at the top of the view).

ADS-B Weather

Overview

ForeFlight Mobile can display ADS-B FIS-B weather data from a number of supported portable and installed ADS-B receivers. See <https://foreflight.com/connect/> for full details about the currently supported receivers. Please consult your specific device's documentation to learn about how to set up and connect the device.

ADS-B Weather Products

These are the weather products available from ADS-B:

- ❖ Radar - local and CONUS, shown on Maps. See radar color vs. intensity legends for [Rain](#).
- ❖ Lightning
- ❖ Turbulence
- ❖ [Cloud Tops](#)
- ❖ METARs and METAR-derived data such as temperature on Maps page.
- ❖ TAFs
- ❖ Winds Aloft, at airport locations on Maps page, and Airports page.
- ❖ TFRs on Maps page **SEE IMPORTANT NOTICE BELOW**
- ❖ PIREPs on Maps page
- ❖ AIRMETs/SIGMETs (including Graphical AIRMETs) and CWAs on Maps page
- ❖ Special Use Airspace status - shown on Maps page when viewing airspace details. Hold finger on airspace to view pop-over. Make sure **All** is selected at bottom of pop-over to see airspace details.
- ❖ Outage messages - messages about outages in ADS-B system can be viewed in More > Devices > status view.

The items listed above are viewed just as they are when on the ground using an Internet connection. There is no user-configuration required beyond ensuring the iPad or iPhone is connected to the ADS-B receiver's Wi-Fi or Bluetooth connection.

TFRs IMPORTANT NOTICE:

While using an ADS-B receiver, up-to-date graphical TFR information is ONLY displayed if you select the TFR Map layer.

However if the FAA publishes a TFR without associated graphical shape information it may not be possible for ForeFlight Mobile to show the graphical TFR on the Maps page.

You should ALWAYS check the Airports page, under NOTAMS > TFRs for airports along your route, and contact FSS or ATC to confirm that your route does not cross any such TFRs.

TFR data may not be updated or displayed if you are using an ADS-B receiver that does not “replay” data received while the iPad is “asleep” or is not connected. Weather Replay in the Sentry, and Stratus 2/2S/3 saves 30 minutes of recent TFR data for display when ForeFlight Mobile is re-opened. TFR data may also not be updated or displayed if the ADS-B receiver is not receiving data from ADS-B towers, or if the ADS-B towers are not broadcasting information about that TFR.

ADS-B Information

When an ADS-B receiver is connected and a Map layer such as Radar or Traffic that uses ADS-B is selected, a data quality indicator is shown in the upper-left corner of the Map, underneath the timestamp. If known, the name of the receiver (such as “Stratus”) is shown to the left of the data quality indicator.

No Data is shown in White when the ADS-B receiver is receiving data from towers but no ADS-B weather data has yet been received. Typically this will only be shown for a couple of minutes at the beginning of a flight.

No Towers is shown in Red when the ADS-B receiver isn’t receiving data from any ground-based towers;

Marginal is shown in Orange when the ADS-B receiver is receiving data from a small number of towers;

Good is shown in White when data is being received from more towers:

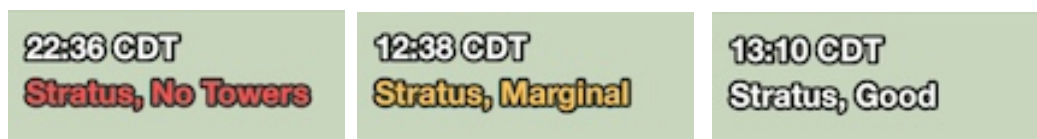

Animated ADS-B Radar

When the Radar layer is selected on the Maps page, the animation play button is displayed in the lower-left corner of the screen. ForeFlight Mobile will animate (loop) up to 5 frames of NEXRAD data. Regional NEXRAD (within ~250 nm of your position) is updated every 5 minutes, while CONUS radar is updated every 15 minutes.

If you tap the play button before 2 or more frames of radar data have been received, you will see a message that the radar cannot be animated until more data is received.



Tap the Maps Settings (gear) button and then select the ADS-B receiver > Status to see how many radar frames have been received.

Settings	Stratus Status
DEVICE	
Connected	Yes
Battery	99%
Power Source	Battery
Serial Number	
Firmware	1.4.0.396
Driver Version	2.6.B6
DATA	
Local Radar Update	None
National Radar Update	None
Radar Frames	0
Text Update	None
Text Report Count	0
Receiving From	1 Tower >
STRATUS REPLAY	
Status	Up-to-date
TRAFFIC	

ADS-B Tower Location on Map

When **Show ADSB Towers** is **ON** in the [ADS-B receiver] > Status settings menu, the location of each ADS-B Tower currently being received is shown on the Map.



The Lat/Long location of each tower is shown under the tower icon, and the type of tower (Low, Medium, or High) is shown next to the tower. This table from the AIM (available in Documents > Drive > FAA) shows the differences between the weather data sent from each type of ADS-B tower.

THL 7-1-2
Product Parameters for Low/Medium/High Altitude Tier Radios

Product	Surface Radius	Low Altitude Tier	Medium Altitude Tier	High Altitude Tier
CONUS NEXRAD	N/A	CONUS NEXRAD not provided	CONUS NEXRAD imagery	CONUS NEXRAD imagery
Winds & Temps Aloft	500 NM look-ahead range	500 NM look-ahead range	750 NM look-ahead range	1,000 NM look-ahead range
METAR	100 NM look-ahead range	250 NM look-ahead range	375 NM look-ahead range	CONUS: CONUS Class B & C airport METARs and 500 NM look-ahead range Outside of CONUS: 500 NM look-ahead range
TAF	100 NM look-ahead range	250 NM look-ahead range	375 NM look-ahead range	CONUS: CONUS Class B & C airport TAFs and 500 NM look-ahead range Outside of CONUS: 500 NM look-ahead range
AIRMET, SIGMET, PIRLP, and SUA/ SAA	100 NM look-ahead range. PIRLP/SUA/ SAA is N/A.	250 NM look-ahead range	375 NM look-ahead range	500 NM look-ahead range
Regional NEXRAD	150 NM look-ahead range	150 NM look-ahead range	200 NM look-ahead range	250 NM look-ahead range
NOTAMs D, FDC, and TFR	100 NM look-ahead range	100 NM look-ahead range	100 NM look-ahead range	100 NM look-ahead range

ADS-B Traffic

Overview

ForeFlight Mobile can display ADS-B TIS-B traffic from a number of supported portable and installed ADS-B receivers. See <https://foreflight.com/connect/> for full details about the currently supported receivers. Please consult your specific device's documentation to learn about how to set up and connect the device.

IMPORTANT TRAFFIC NOTICE

TRAFFIC DISPLAY FEATURES MAY NOT SHOW ALL AIRCRAFT IN THE AREA AND ARE NOT TO BE USED AS A PRIMARY MEANS OF AIRCRAFT VISIBILITY, DETECTION OR AVOIDANCE. TRAFFIC DISPLAYED WILL VARY DEPENDING ON ADS-B COVERAGE AREAS AND ON THE TYPE AND VERSION OF ADS-B "IN" AND ADS-B "OUT" EQUIPMENT INSTALLED IN YOUR AIRCRAFT AND OTHER AIRCRAFT.

IF YOUR AIRCRAFT IS NOT EQUIPPED WITH ADS-B "OUT", YOU WILL NOT RECEIVE A COMPLETE PICTURE OF TRAFFIC. YOU MAY EVEN RECEIVE NO TRAFFIC AT ALL. THIS IS DUE TO THE DESIGN AND IMPLEMENTATION OF THE ADS-B/TIS-B SYSTEM BY THE FAA.

Traffic Access in ForeFlight Mobile

Some ADS-B receivers like the Stratus 1/1S include a single-band 978 MHz UAT receiver, while dual-band receivers like the Sentry and Stratus 2/2S/3 include a dual-band 978 MHz UAT + 1090 MHz receiver. ADS-B traffic may be transmitted over one or both bands. Aircraft operating above 18,000' use the 1090ES band, though these aircraft continue to broadcast on 1090ES when descending below 18,000'.

Important Note:

ADS-B traffic data is NOT saved by Weather Replay. ForeFlight Mobile must be running in order for ADS-B traffic to be displayed.

To display Traffic, tap the Maps drop-down and select the Traffic layer. Use the “Hide Distant Traffic” Setting (later in this section) to hide traffic beyond 15nm or +/- 3,500’ from your location.







Status Information

To learn the status of the ADS-B receiver connection, data availability and more, use the Devices view as described above. When connected, the ADS-B receiver will be an option shown in the Devices view. Tap it to see full status information including the traffic updates received from ADS-B ground stations and aircraft on 978/UAT and 1090 bands.

Traffic Symbols

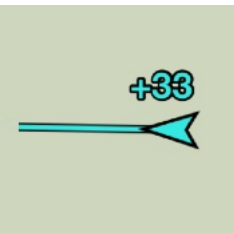
Moving traffic targets are displayed as “arrowheads” pointing in the direction that the target is traveling. Stationary targets, or ones with no direction or speed information, are shown as diamonds. Airborne traffic targets are shown in blue while surface targets are shown in brown. When a traffic target is within 1.8 NM horizontally and +/- 1,200’ vertically of your current position, the target’s color changes to yellow.

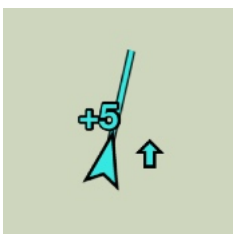
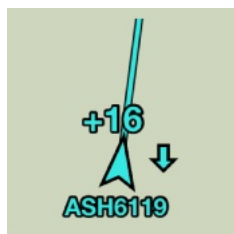
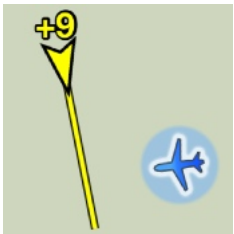
The relative altitude (in 100’s of feet) between your current altitude and the target’s altitude is shown with a + indicating above and a - indicating below your current altitude.

<p>Moving target (+33 is 3,300’ above)</p>		<p>Stationary target, or unknown direction/speed (-30 is 3,000’ below)</p>	
<p>Climbing >500 ft/min (+5 is 500’ above)</p>		<p>Descending >500 ft/min (+16 is 1,600’ above)</p>	
<p>Within 1.8 NM and +/- 1,200 (+9 is 900’ above)</p>		<p>Ground target (brown)</p>	

The TrafficTrend™ vector is projected out of the front of the arrowhead to indicate the target’s expected position in the next 60 seconds (longer vector = faster speed).

IMPORTANT: Because of the way the ADS-B system (including aircraft ADS-B transmitters & receivers, and ADS-B ground stations) operates, ForeFlight Mobile may at times show relative altitudes of traffic targets based on the pressure altitude detected from your aircraft’s ADS-B transmitter, and the pressure altitude read from a traffic target’s ADS-B data. As a result of the cumulative inaccuracies in pressure altitude systems, you should consider any target shown to be within 500’ vertically as potentially being at the same altitude as your aircraft. Never use ADS-B traffic data

from ForeFlight Mobile as the sole means of traffic avoidance; always use “See & Avoid” or direct instructions from ATC.

NOTE: Some transmitted traffic data can be incomplete at times, so aircraft flight/ tail number, vertical speed and TrafficTrend vector may not be available for one or more targets.

Aircraft equipped with ADS-B “Out” transmit additional data such as their tail or flight number, which is shown below the target symbol.

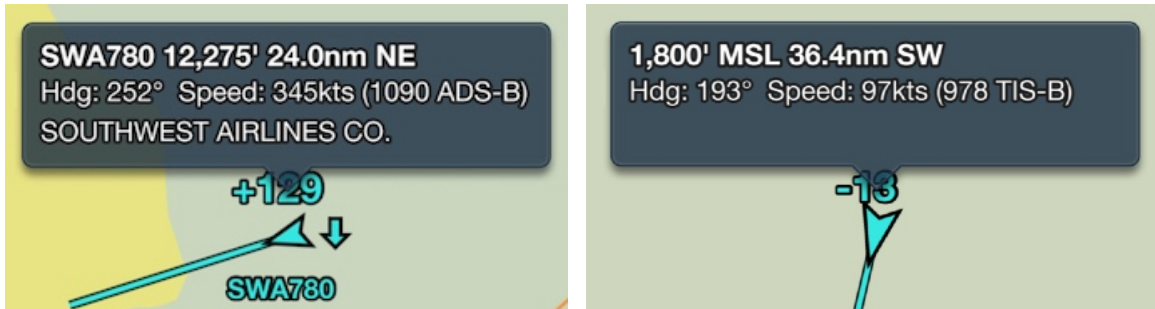

You can tap on any target to display a popup with additional information, which can include target tail or flight number, heading, speed, relative direction and altitude vs, your current position, and whether the information was broadcast via 978 or 1090.

Note: Garmin ADS-B devices do not specify what frequency a traffic target was broadcast on.

If the traffic target has a three-letter callsign, the popup will also show the phonetic name for that callsign as well as the company name it refers to. Tap anywhere outside the popup to close it.

Hide Distant Traffic Setting

The Hide Distant Traffic setting, shown when your iPad or iPhone is connected to an ADS-B receiver, is accessed via the “Gear” button on the Maps page or on the More page under Devices > ADS-B receiver > Status.

When switched ON, this hides traffic that is more than 15NM away from your current GPS location and/or more than 3,500’ above or below your current altitude, useful if you are flying in busy airspace or near large airports with lots of commercial traffic. When ON, a “Hiding Distant Traffic” reminder is displayed in the bottom right corner of the Maps page.

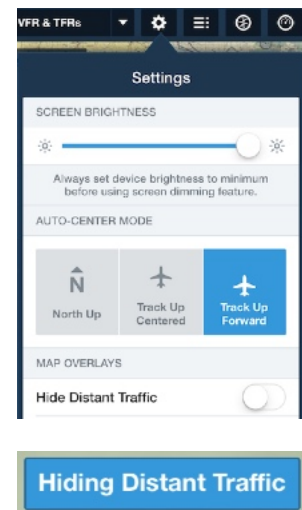

Traffic in Synthetic Vision

In ForeFlight Mobile 10.2 and later, traffic targets within 11nm of your current position are shown in the Synthetic Vision view, including the [SV Glance](#). To convey distance, traffic targets closer to your position are shown in a larger size, and traffic targets fade out beyond 11nm distance away from your position.



Ownship ADS-B Out Information

If your aircraft is equipped with ADS-B Out that is correctly configured and transmitting, tap the **Ownship ADS-B Out** entry in ADS-B Receiver Status to see the tail-number, altitude and location being broadcast by your ADS-B Out equipment.

If your aircraft is not equipped with ADS-B Out, or the ADS-B Out is improperly configured or is not transmitting, the **Ownship ADS-B Out** entry shows **Not Detected**.

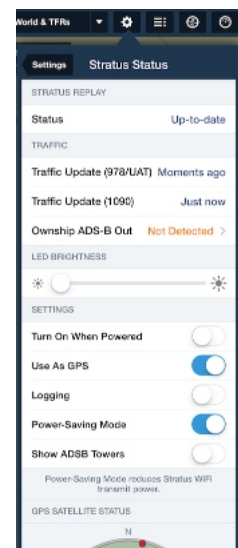

Traffic Alerts

When the **Traffic Alerts** setting is *ON* in **More > Settings > Alerts**, a traffic popup will be displayed if your aircraft is moving at over 40kts and an ADS-B traffic target comes within 1.8 NM horizontally and +/- 1,200' vertically of your aircraft's position.

The popup includes "clock" direction (relative to your aircraft's current track) and relative altitude information to help you locate the target more quickly.

If ForeFlight detects that your aircraft is equipped with ADS-B Out, an audio alert will also be issued with the same information as the visual popup. If no ADS-B Out is detected, **you will not receive traffic audio alerts.**

If your aircraft is not equipped with ADS-B Out but you fly within range of the traffic "puck" around another aircraft that is equipped with ADS-B Out, you may see a false target representing your aircraft, and a visual traffic alert may also be displayed.

NOTE: Traffic alerts are **ADVISORY** in nature and are **NOT** a replacement for "See & Avoid" or ATC traffic advisories.

IMPORTANT: Because of the way the ADS-B system (including aircraft ADS-B transmitters & receivers, and ADS-B ground stations) operates, ForeFlight Mobile may at times show relative altitudes of traffic targets based on the pressure altitude detected from your aircraft's ADS-B transmitter, and the pressure altitude read from a traffic target's ADS-B data. As a result of the cumulative inaccuracies in pressure altitude systems, you should consider any target shown to be within 500' vertically as potentially being at the same altitude as your aircraft. Never use ADS-B traffic data from ForeFlight Mobile as the sole means of traffic avoidance; always use "See & Avoid" or direct instructions from ATC.

Like the Runway Proximity Advisor™, the Traffic Alert popup will display on any screen in ForeFlight Mobile. However if ForeFlight Mobile is not displayed on the screen (e.g., if you are viewing another app, or the iPad or iPhone is sleeping) Traffic Alert popups will not be shown.



ForeFlight Connect

Overview

ForeFlight Connect allows ForeFlight Mobile to wirelessly connect to and exchange information with portable devices as well as panel-mount avionics to make flying easier, safer and more efficient.

Sentry ADS-B Receiver, with GPS, ARHS, and CO Sensor

Sentry is a compact, high-performance portable dual-band ADS-B receiver developed by ForeFlight and uAvionix that enables the display of inflight weather and traffic in ForeFlight Mobile. Sentry also includes an integrated Carbon Monoxide (CO) monitor with in-app alert and loud audio alarm, 12 hours of continuous battery life, built-in WAAS GPS, backup attitude (AHRS), a barometric pressure sensor, onboard memory for Weather Replay™, supports simultaneous connection via Wi-Fi to up to 5 devices, and comes with a RAM® suction-cup mount with quick release. Purchase Sentry on Amazon [here](#).



Sentry has 4 LED indicators on the front:

ADS-B	Carbon Monoxide (CO) Monitor
● Receiving multiple towers	● Normal
● Receiving from one tower	● Caution
● No reception	● Danger
GPS	Power
● Good fix	● Battery good (>30%)
● Bad fix	● Battery low (<30%)
● No fix	● Battery critical (<20%)

Connecting to Sentry

After powering on Sentry, open **Apple Settings** > **Wi-Fi** and select “Sentry-XXXX” (where “XXXX” is a series of numbers and letters) to connect to Sentry’s Wi-Fi network.

Sentry AHRS Setup

After connecting to Sentry for the first time a setup prompt is displayed. In order for the SV display to be correct you must select the Sentry’s mounting orientation. If using the suction mount on a window, choose the Left or Right orientation. If placing the Sentry on the dash or flat, choose the Dash orientation.

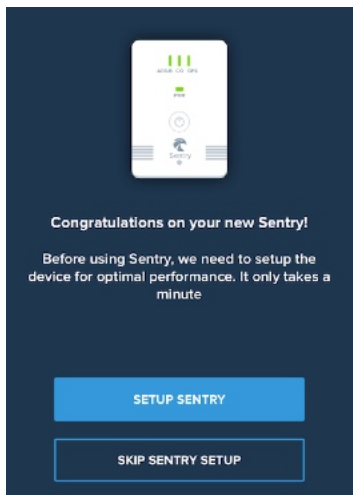

iPad Sentry Setup

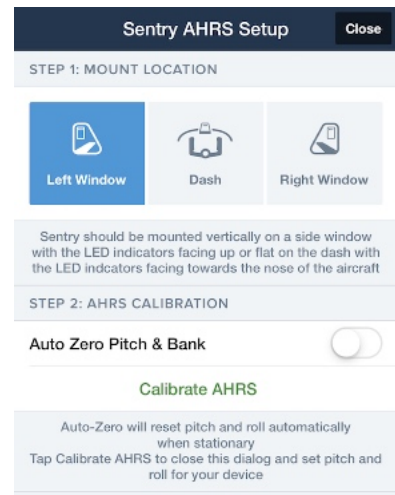
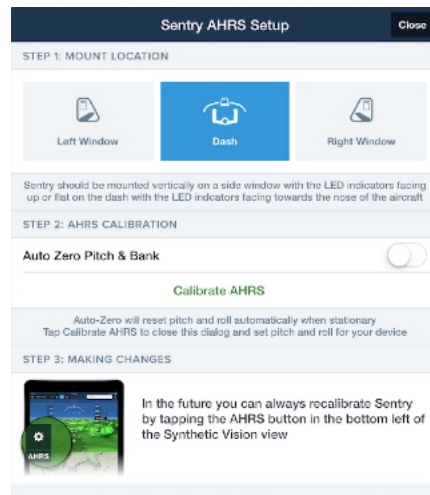

iPhone Sentry Setup

Using Sentry

After connecting to Sentry, open ForeFlight Mobile and tap on More > Devices. You should see a box for Sentry indicating that the connection is established and listing the data being received from Sentry.

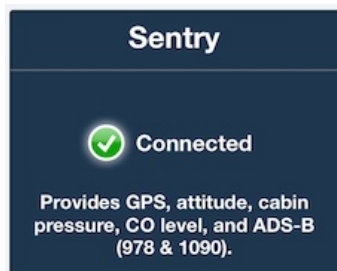

Tapping this box will open Sentry’s status page, providing detailed information about the device and the data being received from it.

There are three settings switches that can be adjusted at the bottom of Sentry's status page:

- ❖ Logging - used only for diagnosing problems, this manages logging of ADS-B data stream received by Sentry. You should leave this OFF normally, as it reduces app performance.
- ❖ Show ADS-B Towers - show the location on the Map of the ADS-B Towers currently being received.
- ❖ Use as GPS - turn ON to use the Sentry's WAAS GPS in ForeFlight Mobile.

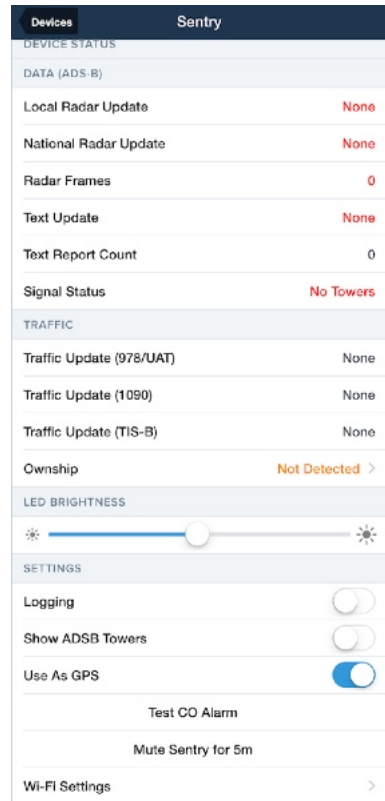

You can change the Sentry's Wi-Fi settings (including SSID name, and activating WPA2 security) by tapping the Wi-Fi Settings box. Requirements for the SSID and WPA2 passcode are shown for quick reference.

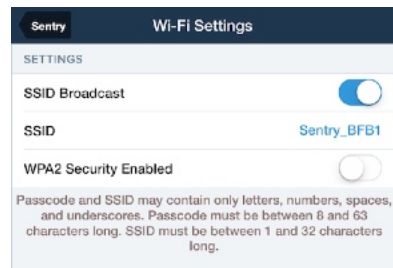

Carbon Monoxide (CO) Monitor

The Sentry incorporates an electronic Carbon Monoxide (CO) monitor that continually measures the concentration of CO. If CO concentration rises to a Caution level, the CO LED turns yellow and an alert is displayed in the app. If the CO concentration rises to a Danger level, the loud built-in alarm is activated, and an in-app alert is also shown.

You can mute the loud alarm by briefly pressing the Sentry's power button.

To test the CO alarm, tap the "Test CO Alarm" button. Briefly press the Sentry's power button to cancel the alarm test.

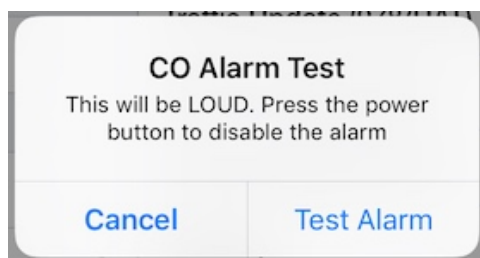

IMPORTANT: the alarm is **LOUD!** Do not hold the Sentry close to your ears while testing.

Updating Sentry's Firmware

Firmware updates for Sentry are included in new versions of ForeFlight, allowing you to easily update the device directly within ForeFlight.



If a new firmware update is available, a message will appear when you connect to Sentry and open ForeFlight. Go to More > Devices and tap on the Sentry tile, then tap "Tap to Update" to begin the update process.

Scout ADS-B Receiver

Scout is a dual-band ADS-B receiver developed by ForeFlight and uAvionix that enables the display of inflight weather and traffic in ForeFlight Mobile. For instructions on how to power Scout, download the Scout Quickstart Guide from the Documents view Drive, in the ForeFlight section. Purchase Scout on Amazon [here](#).



Note: Scout does not include a GPS and will not provide position information in ForeFlight. If using Scout with a device that does not include an internal GPS you will need to use an external GPS receiver to see your position in ForeFlight.

Connecting to Scout

After powering on Scout, open **Apple Settings** > **Wi-Fi** and select "Scout-XXXX" (where "XXXX" is a series of numbers and letters) to connect to Scout's Wi-Fi network. If connecting to an early production Scout for the first time the Wi-Fi name will be "Ping-XXXX"; a firmware update will be immediately available in ForeFlight to update the Wi-Fi name to "Scout-XXXX".

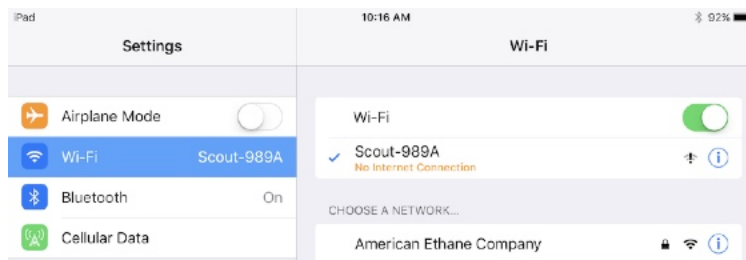

Using Scout

After connecting to Scout, open ForeFlight Mobile and tap on More > Devices. You should see a box for Scout indicating that the connection is established and listing the data being received from Scout.

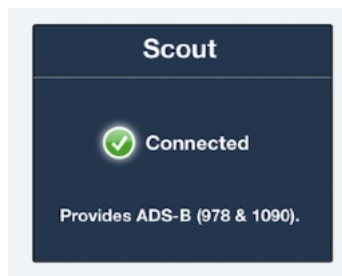

Tapping this box will open Scout's status page, providing detailed information about the device and the data being received from it.

There are two settings that can be adjusted at the bottom of Scout's status page:

- ❖ Logging - used only for diagnosing problems, this manages logging of ADS-B data stream received by Scout. You should leave this OFF normally, as it reduces app performance.
- ❖ Show ADS-B Towers - show the location on the Map of the ADS-B Towers currently being received.

ADS-B From Scout

When an ADS-B layer such as Radar or Traffic is selected on the Maps view, the [quality of ADS-B signal](#) being received by Scout is shown in the upper-left corner of the view below the timestamp indicating when the last update was received.

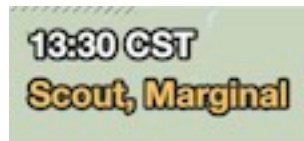

Updating Scout's Firmware

Firmware updates for Scout are included in new versions of ForeFlight, allowing you to easily update the device directly within ForeFlight.

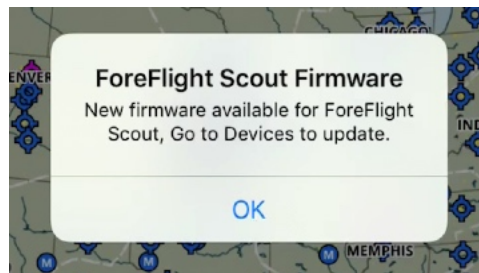

If a new firmware update is available, a message will appear when you connect to Scout and open ForeFlight. Go to More > Devices and tap on the Scout badge, then tap "Tap to Update" to begin the update process.

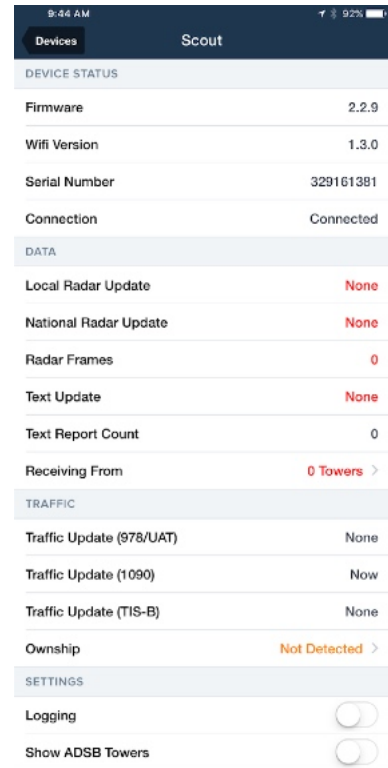

Stratus ADS-B Receivers

ForeFlight Mobile supports the Stratus family of ADS-B receivers, which are manufactured in the USA by Appareo. These devices provide ForeFlight Mobile with the ability to access ADS-B FIS-B (weather) and TIS-B (traffic) data from the network of ADS-B ground stations. Please consult the Stratus documentation to learn about how to set up and connect the device.

Multiple iPads or iPhones running ForeFlight Mobile can simultaneously connect to a Stratus using Wi-Fi. There is no significant practical limit to the number of iOS devices that can be connected to Stratus at once.

It is recommended that cellular data be turned OFF when using a Stratus ADS-B receiver.

Stratus Status Information

To see more detailed Stratus status information, tap the Map Settings “gear” button and then tap the Stratus entry, or tap on **More > Devices > Stratus > Status**. Scroll down to see additional data and Settings.

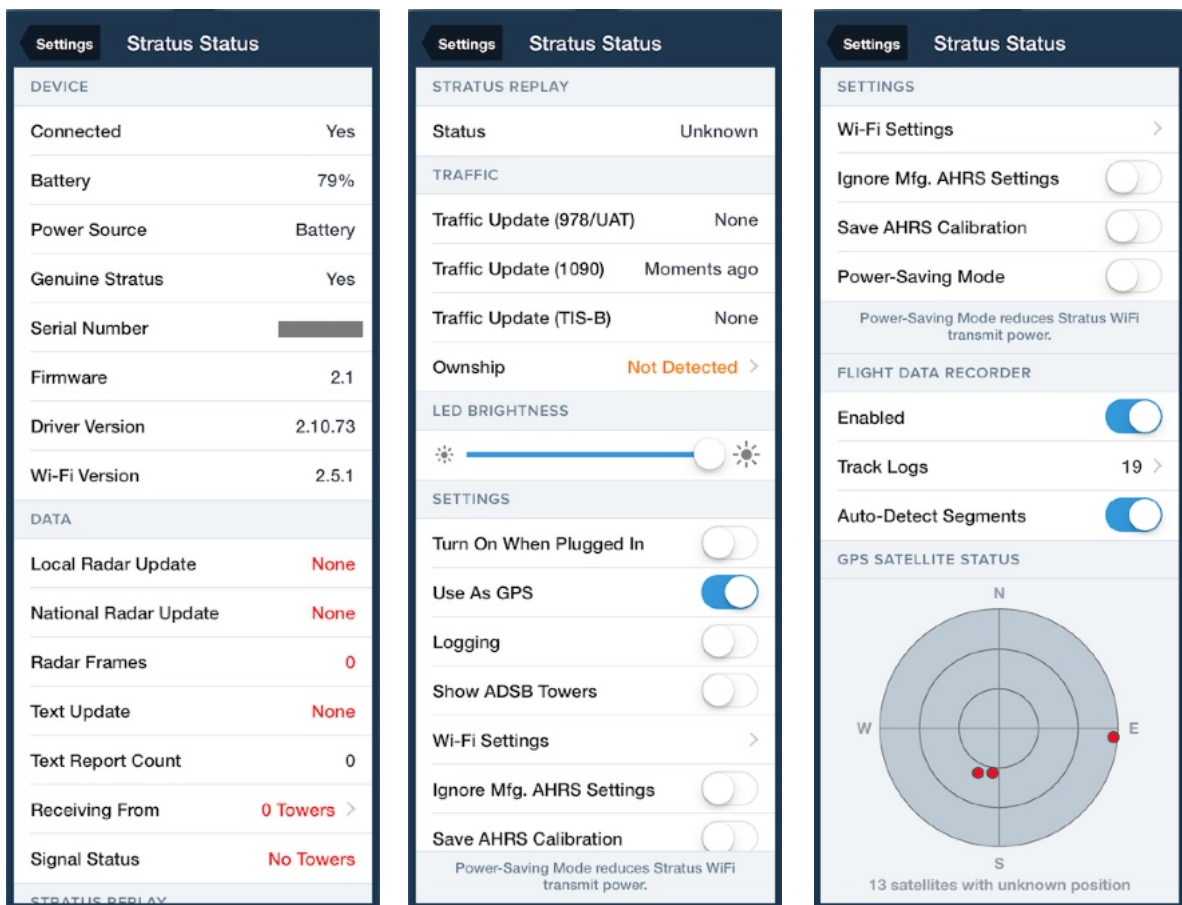

The following details and Settings are provided on the Status view:

- ❖ Connected - shows “Yes” if a Stratus is connected via Wi-Fi.
- ❖ Battery - indicates remaining battery life in percent remaining. Not shown when charging Stratus.
- ❖ Power Source - indicates whether Stratus is being charged.
- ❖ Serial Number - Stratus serial number, only needed for technical support concerns.
- ❖ Firmware, Driver, and Wi-Fi versions - current versions of firmware installed on Stratus.
- ❖ Local/National Update - date of most recent radar data, local data is generally < 5m old, national is generally < 15m old.
- ❖ Text Update - last time a new text report was downloaded (ex. METAR, TAF, Winds Aloft).
- ❖ Text Report Count - number of ADS-B-provided text reports in ForeFlight Mobile.
- ❖ Receiving From - number of ground-based towers currently providing Stratus with data.
- ❖ Stratus Replay Status (Stratus 3/2S/2/1S Only) - indicates if the ADS-B data saved by Stratus, while ForeFlight Mobile was in the background or the iPad was sleeping, has been sent to ForeFlight Mobile. Up to 30 minutes of data is saved.
- ❖ Traffic Update (978/UAT) and (1090) - when traffic data was received on either band (1090 requires Stratus 3/2S/2).
- ❖ Ownship - if your aircraft is equipped with ADS-B Out, tap this entry to display the information detected by the Stratus about your ADS-B Out transmissions.
- ❖ LED Brightness - used to adjust brightness of LEDs on Stratus.
- ❖ Turn On When Plugged In - when ON the Stratus will turn on when power is provided over the USB cable and turn OFF when power is removed. When power is removed the Stratus will turn OFF in 2 minutes only if the speed is < 5 knots. If speed is > 5 knots, the Stratus will not turn off until the speed drops below 5 knots, or the power button is pressed.
- ❖ Use As GPS - when ON, the Maps and other views will use GPS fix info from Stratus.

- ❖ Logging - used only for diagnosing problems, this manages logging of ADS-B data stream received by Stratus. Leave this OFF normally, as it reduces app performance.
- ❖ Show ADS-B Towers - show the location on the Map of the ADS-B Towers currently being received.
- ❖ Wi-Fi Settings - implements Wi-Fi security for the Stratus local network. Disabling SSID Broadcast makes your network's name invisible to other iPads/iPhones, preventing them from joining your Stratus network unless they know the name of the network. **WPA2 Security should NOT be enabled.** Changes to the Stratus Wi-Fi Settings require that the device be restarted. **Note:** If you forget the Network name or WPA2 passcode you set for your device, perform a factory reset to return it to default conditions: SSID Broadcast - Enabled, WPA Security - OFF, and no passcode. You can perform a factory reset by holding the Stratus power button for 30 seconds
- ❖ Ignore Mfg. AHRS Settings (Stratus 3, 2S, and 2) - when ON, Stratus will automatically reinitialize its AHRS every time it is powered on. **It is recommended that this setting remain OFF** unless the Stratus is providing subpar AHRS readings, which could happen after the Stratus is dropped or is subjected to very large temperature variations. If you are receiving subpar AHRS readings, turn this setting ON and power cycle the Stratus while keeping the device as stationary as possible for at least 10 seconds after power-up is complete.
- ❖ Save AHRS Calibration (Stratus 3, 2S, and 2) - when ON, Stratus will save a manual AHRS calibration between power cycles so it does not automatically re-adjust to straight and level every time it is turned back on. This setting is useful for pilots who cannot calibrate the Stratus on the ground due to their aircraft (or Stratus device) not being straight and level, such as with tail dragger aircraft. **Note:** The use of this feature depends on the Stratus not being repositioned after it is calibrated; repositioning the Stratus between flights will cause the saved calibration to become inaccurate, requiring a re-calibration during the next flight.
- ❖ Cabin is pressurized - (Stratus 3 and 2S) turn ON if flying in a pressurized aircraft.
- ❖ Power-Saving mode - reduces the Wi-Fi transmit power to increase battery life.
- ❖ Auto Shutoff mode (Stratus 3 only) - turn ON have the Stratus 3 shut-down automatically if no GPS lock is received within 30 minutes, or if the Stratus 3 is moving at <5 knots for 30 minutes. This setting helps prevent the Stratus 3 battery from draining if it is inadvertently turned on or is left on after a flight.

- ❖ Flight Data Recorder (Stratus 3, 2S, and 2) - when "Enabled " is *ON*, Stratus will begin recording a track log as soon as it is turned on and the GPS senses motion (see [Stratus Flight Data Recorder](#) for more information)
- ❖ Track Logs (Stratus 3, 2S, and 2) - tap to view any track logs recorded by Stratus.
- ❖ Auto-Detect Segments (Stratus 3 and 2S) - when *ON*, Stratus will automatically detect trip segments based on your ground speed and create a separate track log for each segment.
- ❖ GPS Satellite Status - shows location and signal lock for GPS satellites currently visible.

Stratus ESG (Stratus 1S/2/2S/3 Only)

Stratus ESG is Appareo's all-in-one certified ADS-B Out transponder solution. The Stratus 1S, 2, 2S, or 3 can connect to Stratus ESG via USB cable (included in the Stratus ESG installation kit provided by the avionics dealer) to take advantage of the Stratus ESG's certified WAAS GPS receiver and aircraft-mounted ADS-B antenna to boost GPS accuracy and provide improved ADS-B In tower reception. When connected via the USB cable, the Stratus ESG also supplies power to the Stratus 1S, 2, 2S, or 3 to keep the battery charged.

When a Stratus 1S, 2, 2S, or 3 is connected to the Stratus ESG, the Accuracy instrument in ForeFlight's [Instrument Panel](#) will show "Accuracy (ESG)" to indicate that it is receiving GPS position data from the ESG.

Stratus Replay (Stratus 1S/2/2S/3/3 Only)

Stratus Replay saves the last 30 minutes of ASD-B weather information received by the device, including NEXRAD Radar, METARs, TAFs, etc. Stratus Replay automatically sends saved data to ForeFlight when you reopen the app after sleeping the iPad or iPhone, or switching from another app. This allows you to conserve battery life by opening ForeFlight only when needed without fear of missing useful ADS-B weather information.

Stratus Replay requires that the device be updated to Firmware v1.4 or later for a Stratus 2 and v1.0 or later for a 1S/2S. See [Stratus Firmware Update](#) for instructions on updating the Stratus firmware. **NOTE:** Stratus Replay is not available with the Stratus 1.

You can check the Stratus Replay status by tapping the Map Settings “gear” button and then choosing Stratus, or on **More > Devices > Stratus > Status**.

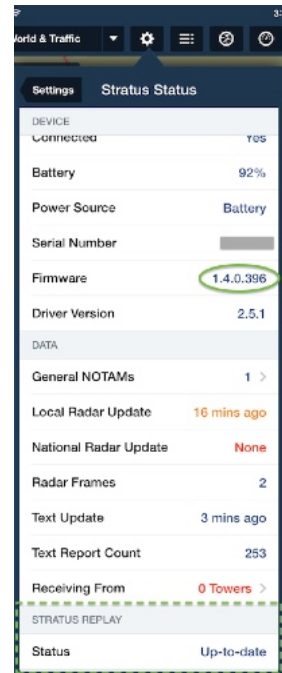

Stratus Flight Data Recorder

The Flight Data Recorder feature allows a Stratus 2/2S to save a Track Log file of your flights. The Track Log file includes your position, speed and altitude data throughout each of your flights, and it can be saved regardless of whether you record a [Track Log](#) in ForeFlight Mobile.

When activated, the Flight Data Recorder will save up to approximately 20 hours of data, and will automatically delete the oldest track log file from the device to make room to record the new track log file..

Recording a Track Log Using the Flight Data Recorder

Turn on the Flight Data Recorder on the Maps page by tapping the **Maps Settings** (gear button) then tapping **Stratus Status**. Alternatively you can tap **More > Devices > Stratus > Status** and slide the “Enabled” switch to ON.

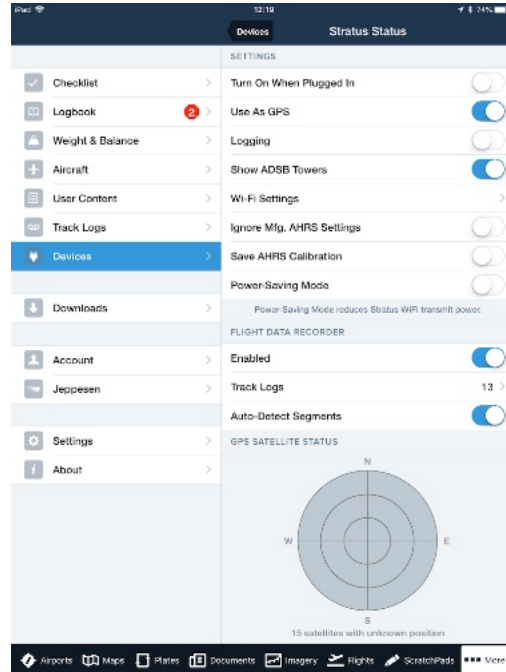
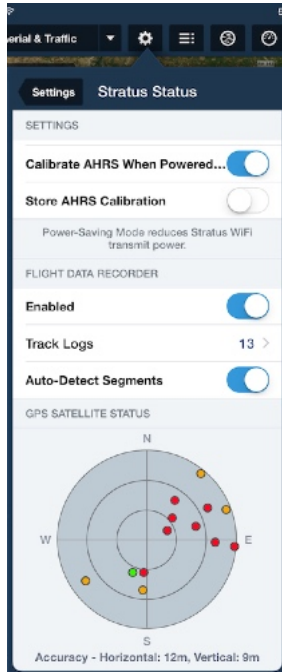

Track log files will begin recording automatically as soon as the Stratus 2/2S/3 is turned on and the GPS senses motion.

The Track Log file will record until the device is turned off, unless “Auto-Detect Segments” is turned ON, in which case a Track Log will stop recording when Stratus detects a full-stop landing, and another Track Log will be started. Once the device is turned back on, the most recent Track Log file or files will be shown in the “Track Logs” count on the **More > Devices > Stratus > Status > Track Logs** view.

When connected to a Stratus 2/2S or 3, Track Logs can be accessed directly from the **More > Track Logs** page by tapping the **Stratus Logs** button, or by tapping **More > Devices > Stratus > Status > Track Logs**.

To save a Track Log to ForeFlight Mobile, tap the “Cloud” icon next to the Track Log.

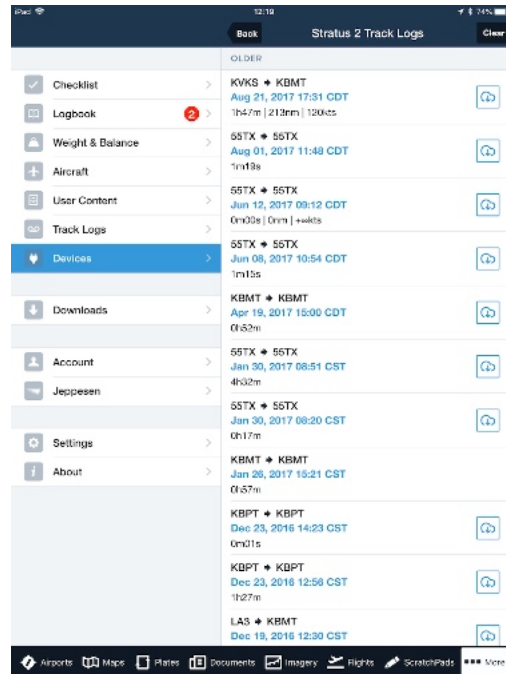
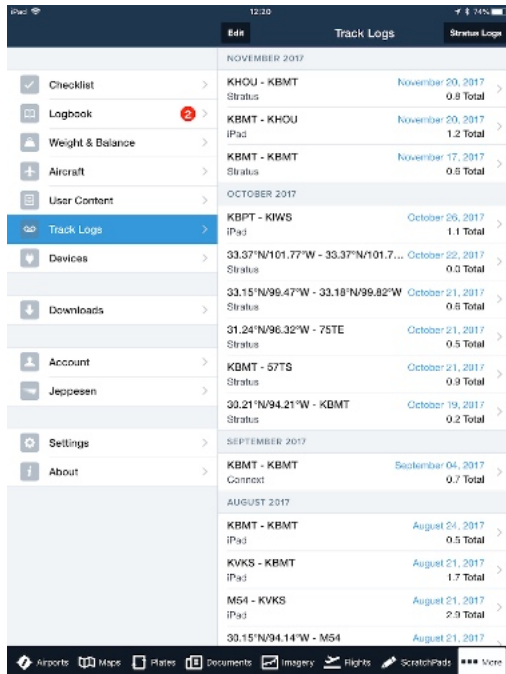

Once that Track Log has been saved to ForeFlight Mobile, you can transfer it to your ForeFlight account where it can be viewed and shared like other Track Logs. Disconnect your iPad from the Stratus 2/2S/3 Wi-Fi network, connect to the Internet, then tap **More** > **Track Logs** and tap the “Cloud” icon next to that Track log. See [Viewing Track Logs on your ForeFlight Account](#) for more details.

Stratus Firmware Update

Appareo, the manufacturer of the Stratus ADS-B receivers, periodically releases updated firmware to activate new capabilities or fix issues.

Before beginning the update process, make sure that your iPad or iPhone AND the Stratus each have enough battery power to run for at least 15 minutes. If you are unsure, plug each device in to an appropriate charger.

Turn the Stratus ON, then open Apple Settings, tap Wi-Fi and connect your iPad or iPhone to the Stratus Wi-Fi network.

Open ForeFlight Mobile, then go to the Devices view and tap the Stratus button.

Then tap the “Tap to Update” on the Firmware row: **Firmware 1.1 - Tap to Update** > to begin the update. Once the update is complete, tap the “Close” button to return to ForeFlight Mobile.

IMPORTANT: The Stratus will reboot during the firmware update process. When this happens, if there is a known Wi-Fi network in range your iPad or iPhone will reconnect to the other Wi-Fi network. This will cause an error message at the end of the update process since ForeFlight Mobile is no longer connected to the Stratus Wi-Fi network and cannot verify the firmware update.

If this happens, simply quit ForeFlight Mobile, re-connect your iPad or iPhone to the Stratus Wi-Fi network, re-open ForeFlight Mobile and go to the Devices, Stratus page. Verify that the new Stratus Firmware version is listed.

You can avoid this error message either by doing the update in an area with no other Wi-Fi networks, or by, before starting the update, opening Apple Settings, tapping Wi-Fi and “forgetting” any Wi-Fi networks to which your iPad or iPhone may automatically connect.

Garmin Connex

The Garmin Connex system allows ForeFlight Mobile to receive GPS position data, ADS-B weather and ADS-B traffic from select Garmin avionics by connecting to a Garmin Flight Stream 110, 210, or 510 bluetooth gateway. The Flight Stream 210 also includes an AHRS sensor, providing pitch and bank information to the attitude display in ForeFlight Mobile, and supports two-way flight plan transfer between ForeFlight Mobile and select Garmin navigation displays. ForeFlight Mobile does not currently support receiving XM Weather or music through a Flight Stream.

Pairing with Flight Stream

Once a Garmin avionics dealer has correctly installed a Flight Stream 110, 210, or 510 and connected it to your Garmin avionics, open Apple Settings and tap the Bluetooth tab on the left. If your Flight Stream is already in Bluetooth pairing mode it will appear in the list of available Bluetooth devices and you can tap on the entry to connect. If it doesn't appear, follow the instructions provided with the Flight Stream to enable Bluetooth pairing mode, then tap the Flight Stream entry to pair it with your device.

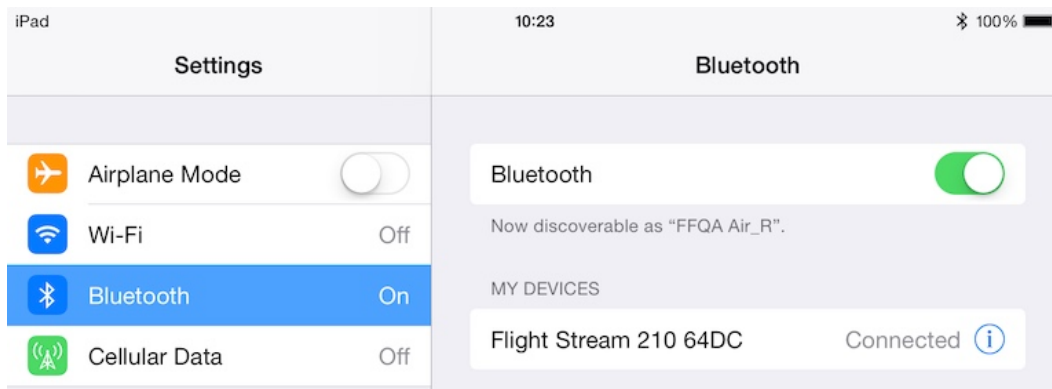

Using Connex

After pairing with the Flight Stream, open ForeFlight Mobile and tap on More > Devices. You should see a box for Garmin Connex indicating that the connection is established and listing the data being received through the Flight Stream.

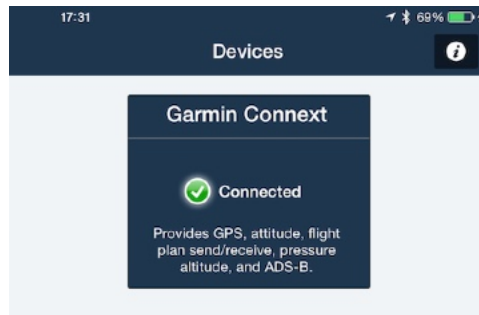

Tapping this box will open the device’s status page, providing detailed information about the device and the data being received from it. In addition to the Flight Stream, the status page will also show any Garmin avionics that are connected to the Flight Stream.

“Attitude from access point” indicates whether AHRS data is being provided by the Flight Stream 210 (the “access point” to the chain of Connex devices) or from another device in the chain.

If connected to a GNS or GTN unit with a route loaded, the details of that route will also be displayed. Tap on the route to load it into ForeFlight Mobile’s Route Editor.

IMPORTANT: DO NOT PRESS the “Reset AHRS” button at the bottom of the Settings page unless specifically directed to by the ForeFlight Pilot Support Team or your Garmin Avionics dealer.

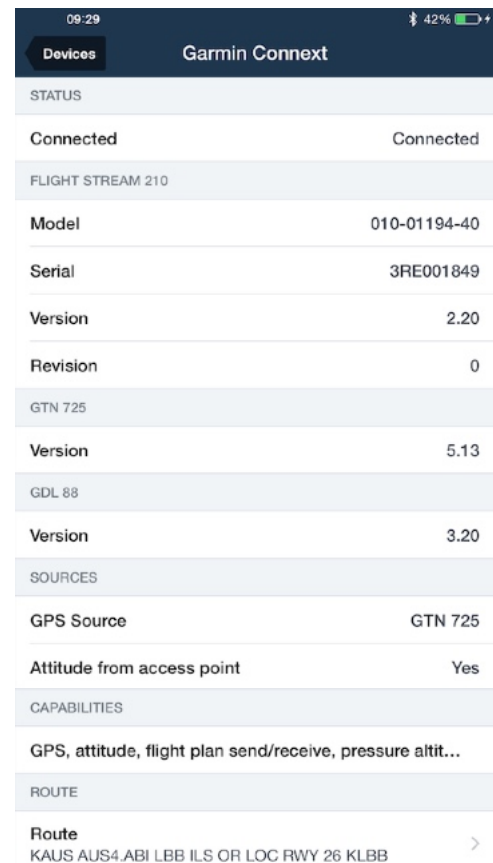

GPS and ADS-B from Connex

When GPS data is being sent from the Flight Stream to ForeFlight Mobile, the Accuracy instrument will show "Accuracy (Connex)."

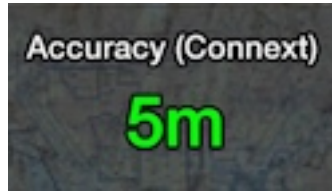

When an ADS-B weather or traffic layer is selected on the Maps view, the [quality of the ADS-B signal being received](#) (No Towers, Marginal, Good) is shown in the upper-left corner of the view below the timestamp indicating when the last update was received.

Sending a Route to Connex (requires Flight Stream 210 or 510)

The Panel button is shown when your device is connected via Bluetooth to a compatible Flight Stream or Connex-equipped device. On an iPad, tap the Panel button at the top of the Maps view and tap “Send to Panel”, or tap the Send To button in the bottom-right corner of the Flight Plan Editor and tap the Panel button to send a route to a GNS 430W/530W or GTN 600/700 series GPS navigator. **NOTE:** Flight Stream 510 only supports route transfer to GTN 600/700 series GPS navigators.

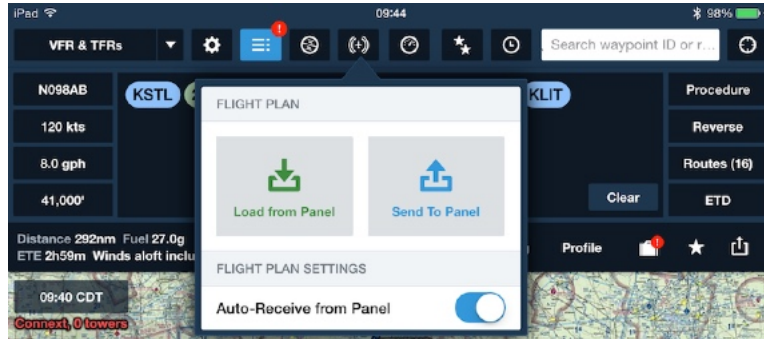

On an iPhone, tap Menu, scroll to the Route section and choose the Route. Then tap the “Send to” button in the bottom-right and tap “Panel.”

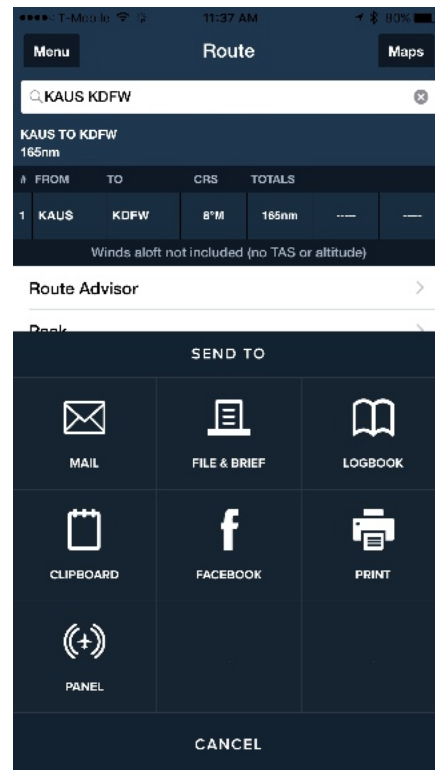
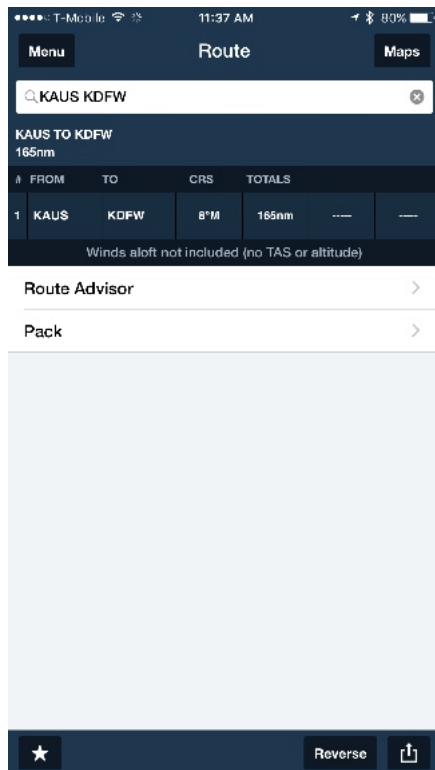

Because Garmin panels require that a runway be specified for most procedures, ForeFlight will prompt you to select a runway before sending to a supported Garmin navigator.

After sending the route a popup will open in ForeFlight confirming that the route has been successfully sent to the panel. Tap "OK" to dismiss the popup.

NOTE: Different Garmin GPS navigators support different numbers of waypoints per route. If you attempt to send a route with a too many waypoints for the installed Garmin GPS, the transfer will be rejected. A possible solution for this is to go to More > Settings > Route View and change the Airway Decoding setting to "Bends Only", which will remove any waypoints that do not result in a change in course. The route must be re-entered for this setting to be applied. After re-entering, you can re-send the route to the Garmin GPS via the Flight Stream 210 or 510.

Getting a Route from Connex (requires Flight Stream 210 or 510)

On an iPad, tap the "Panel" button at the top of the Maps view and tap "Load from Panel" to load a route from your Connex navigator to the ForeFlight Mobile Route Editor.

On an iPhone, go to More > Devices > Connex, or tap the Map Settings button and tap Connex at the bottom. Scroll down to the Route section and tap the route to load it into your Route Editor.

When "Auto-Receive from Panel" is enabled, changes to your route in the Connex device produce a notification in ForeFlight Mobile prompting you to load the modified route into your Route Editor, with options to Load Route or Ignore. When "Auto-Receive from Panel" is disabled, changes to your route in the Connex device do not produce a notification. This setting is also available in More > Settings > Map View as "Auto-Receive Panel Flight Plans."

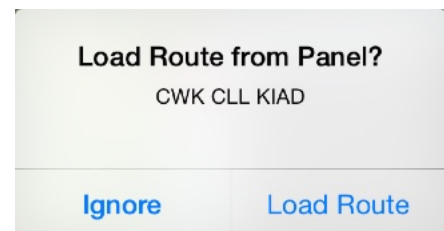

Calibrating Flight Stream 210 AHRS

The FlightStream 210 AHRS can be calibrated by tapping the AHRS Setting button in the attitude display, above the fullscreen button. This will activate Zero Pitch & Bank mode and a blue Save button will appear in the upper left corner of the display. Adjust your aircraft so that it is straight and level, tap the Zero Pitch & Bank button to zero the display, and tap the Save button to save the AHRS calibration.

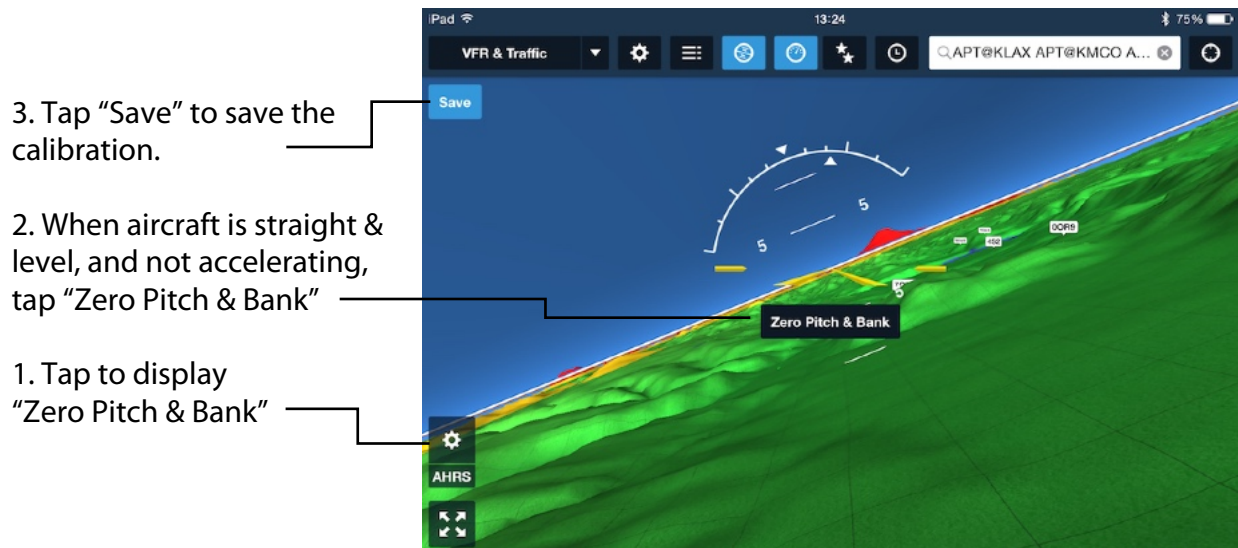

Note: AHRS calibration should only be performed while in level, unaccelerated flight, or while stationary and level on the ground. Calibrating the device while accelerating or decelerating may result in errors in pitch and bank information.

Garmin GTX 345

Garmin's GTX 345 ADS-B Out/In transponder can provide ForeFlight with WAAS GPS position data, ADS-B weather and traffic, pressure altitude, and AHRS information to drive ForeFlight's attitude indicator and Synthetic Vision. The GTX 345 appears in More > Devices as "Garmin Connex", although it can connect directly to ForeFlight via Bluetooth and does not require a separate Flight Stream.

Connecting to GTX 345

After your GTX 345 is installed in your aircraft by a certified Garmin avionics dealer, follow the instructions included with it to enable Bluetooth pairing mode. On your mobile device, open **Apple Settings > Bluetooth** and select the GTX 345 from the list of available devices. The GTX 345 can pair with up to two devices at once.

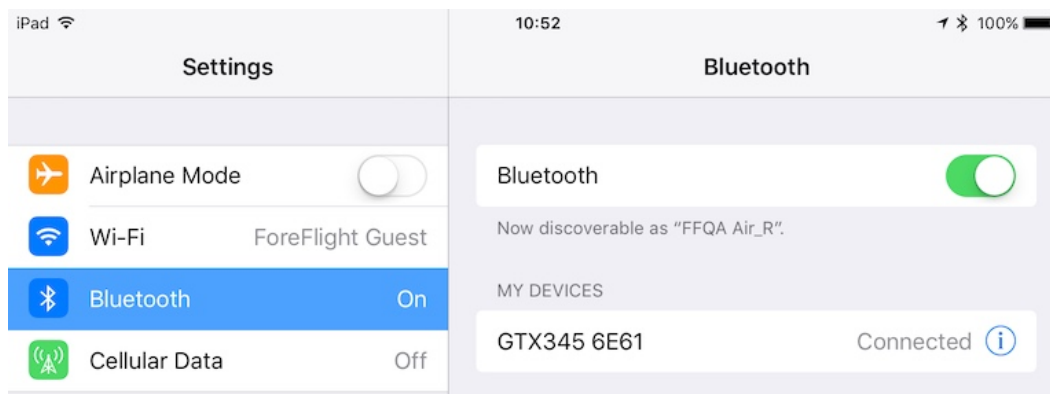

Using GTX 345

Once you've paired with the GTX 345 via Bluetooth, open ForeFlight and tap **More > Devices** to confirm the connection was recognized by ForeFlight and see what information is being received from the GTX 345. GPS is only shown here when a location fix has been established, so it may take a minute to appear immediately after the GTX 345 is powered on.

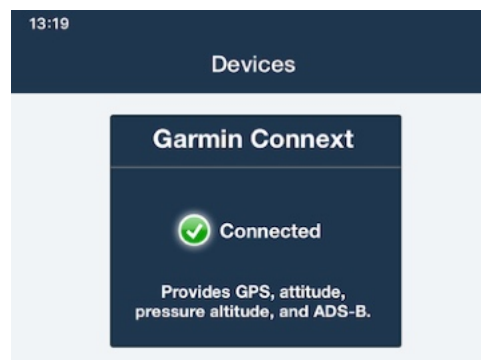

Tap the box to view the details of the GTX 345 and the data being received from it.

There are two settings that can be adjusted at the top of the GTX 345 status page:

- ❖ Use as Pressure Altitude - turn this switch ON to show the pressure altitude data from the GTX 345 on the Maps page as Pressure Altitude.
- ❖ Use as Cabin Pressure Altitude - turn this switch ON to show the pressure altitude data from the GTX345 on the Maps page as Cabin Pressure altitude. Generally this switch should be OFF in a pressurized aircraft.

There are two settings that can be adjusted at the bottom of the GTX 345 status page:

- ❖ Logging - used only for diagnosing problems, this manages logging of ADS-B data stream received by GTX 345. Leave this OFF normally, as it reduces app performance.
- ❖ Show ADS-B Towers - show the location on the Map of the ADS-B Towers currently being received.

The GTX 345 ARHS pitch/roll values (used to drive the Synthetic Vision display) must be initially calibrated by your avionics shop at the time of installation.

GPS and ADS-B from GTX 345

When GPS data is being sent from the GTX 345 to ForeFlight, the Accuracy instrument will show "Accuracy (Connex)."



When an ADS-B weather or traffic layer is selected on the Maps view, the [quality of the ADS-B signal being received](#) (No Towers, Marginal, Good) is shown in the upper-

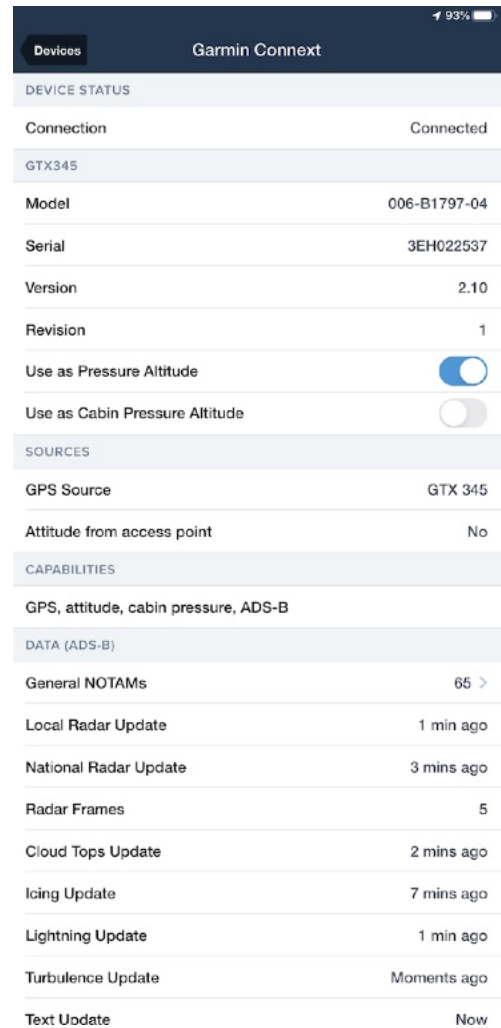

Garmin Connex	
DEVICES	
DEVICE STATUS	
Connection	Connected
GTX345	
Model	006-B1797-04
Serial	3EH022537
Version	2.10
Revision	1
Use as Pressure Altitude	<input checked="" type="checkbox"/>
Use as Cabin Pressure Altitude	<input type="checkbox"/>
SOURCES	
GPS Source	GTX 345
Attitude from access point	No
CAPABILITIES	
GPS, attitude, cabin pressure, ADS-B	
DATA (ADS-B)	
General NOTAMs	65 >
Local Radar Update	1 min ago
National Radar Update	3 mins ago
Radar Frames	5
Cloud Tops Update	2 mins ago
Icing Update	7 mins ago
Lightning Update	1 min ago
Turbulence Update	Moments ago
Text Update	Now

left corner of the view below the timestamp indicating when the last update was received.

Calibrating the GTX 345 AHRS

The GTX 345 AHRS can be calibrated by tapping the AHRS Setting button in the attitude display, above the fullscreen button. This will activate Zero Pitch & Bank mode and a blue Done button will appear in the upper left corner of the display. Adjust your aircraft so that it is straight and level, tap the Zero Pitch & Bank button to zero the display, and tap the Done button to save the AHRS calibration.

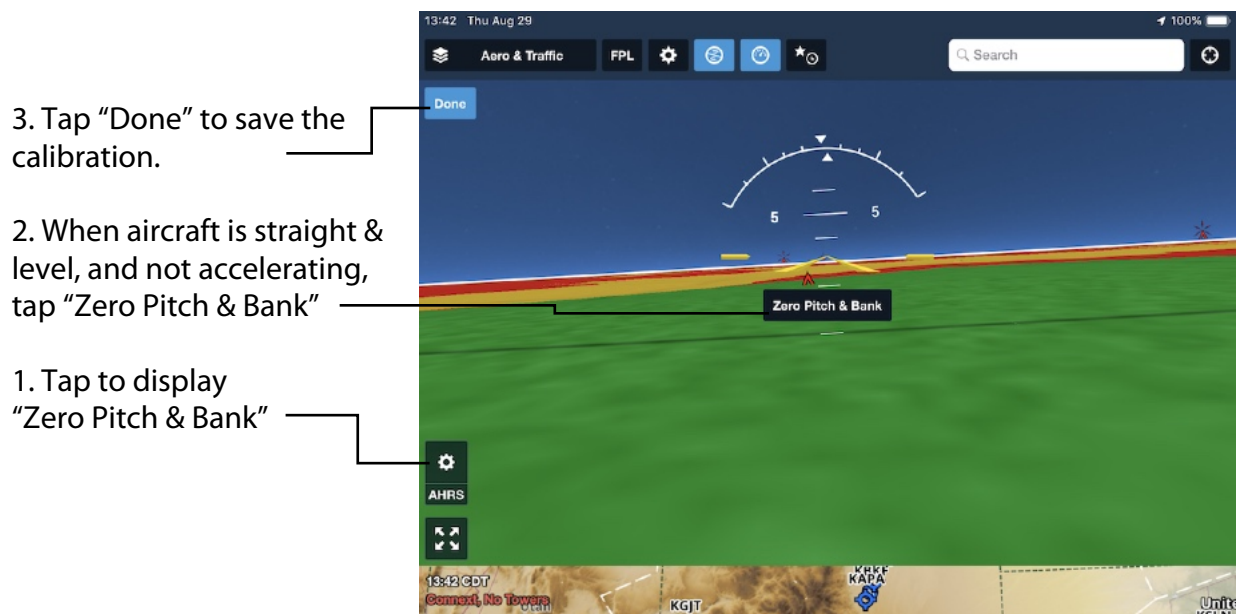

Note: AHRS calibration should only be performed while in level, unaccelerated flight, or while stationary and level on the ground. Calibrating the device while accelerating or decelerating may result in errors in pitch and bank information.

Garmin GDL 39, GDL 50, GDL 51 GDL 52

ForeFlight can connect to Garmin’s GDL 39, GDL 51, GDL 50, and GDL 52 portable (and remote-mount) receivers. All of the receiver include GPS, and their other features are listed below:

Receiver	ADS-B weather & traffic	XM weather	AHRS
GDL 39	X		
GDL 39-3D	X		X
GDL 50	X		X
GDL 51		X	X
GDL 52	X	X	X

The receiver appears in More > Devices as “Garmin ConnexT”, although it can connect directly to ForeFlight via Bluetooth and does not require a separate Flight Stream.

Connecting to GDL 39, GDL 50, GDL 51, or GDL 52

After turning on the GDL 39, open **Apple Settings > Bluetooth** and tap the name to connect to the receiver. ex: “GDL39”:

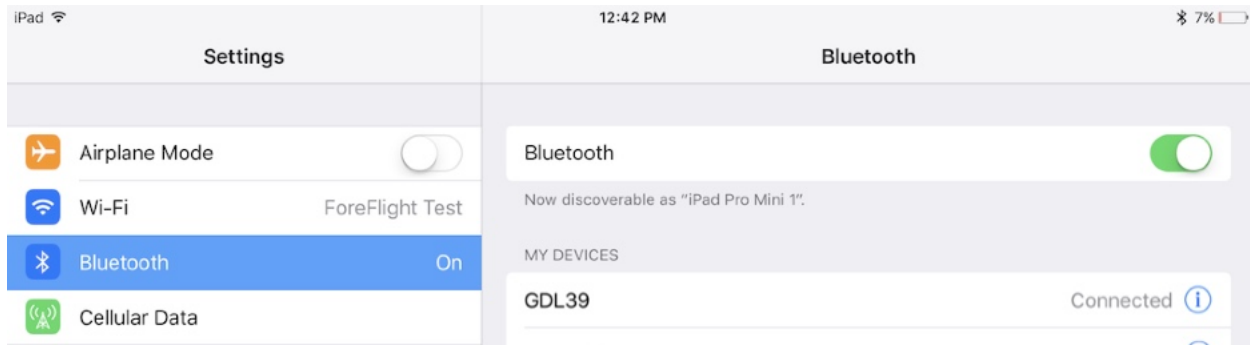

Using the GDL 39, GDL 50, GDL 51, or GDL 52

Once you’ve paired with the receiver via Bluetooth, open ForeFlight and tap **More > Devices** to confirm the connection was recognized by ForeFlight and see what information is being received from the receiver.

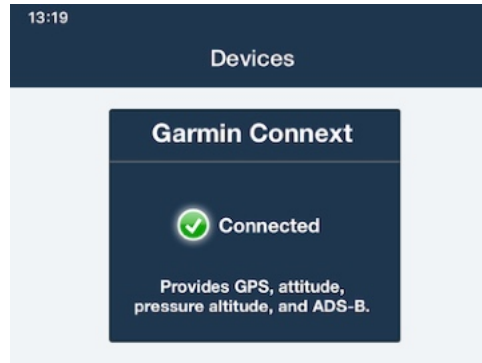

Tap the box to view the details of the receiver and the data being received from it.

There are three settings that can be adjusted at the top of the receiver status page:

- ❖ Pressurized Cabin - Turn this switch ON if the aircraft is pressurized and the receiver is INSIDE the pressurized cabin. Turn this switch OFF if the receiver is OUTSIDE the pressurized cabin.
- ❖ Use as Pressure Altitude - turn this switch ON to show the pressure altitude data from the receiver on the Maps page as Pressure Altitude.
- ❖ Use as Cabin Pressure Altitude - turn this switch ON to show the pressure altitude data from the receiver on the Maps page as Cabin Pressure altitude. Generally this switch should be **OFF in a pressurized aircraft**.

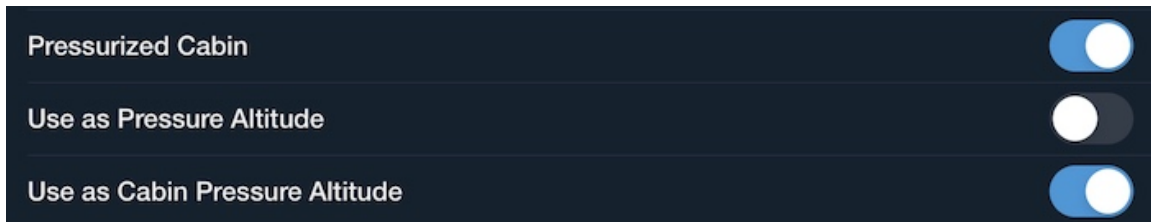

There are three settings that can be adjusted at the bottom of the receiver status page:

- ❖ Logging - used only for diagnosing problems, this manages logging of ADS-B data stream. Leave this OFF normally, as it reduces app performance.
- ❖ Show ADS-B Towers - show the location on the Map of the ADS-B Towers currently being received.
- ❖ Pressurized Cabin - enabling this will cause the receiver to stop sending pressure altitude readings to ForeFlight, since those readings become inaccurate when the device is in a pressurized cabin.

IMPORTANT: DO NOT PRESS the “Reset AHRS” button at the bottom of the Settings page unless specifically directed to by the ForeFlight Pilot Support Team or your Garmin Avionics dealer.



GPS and ADS-B

When GPS data is being sent from the receiver to ForeFlight, the Accuracy instrument will show “Accuracy (Connex).”



When an ADS-B weather or traffic layer (or XM weather layer) is selected on the Maps view, the [quality of the ADS-B signal being received](#) (No Towers, Marginal, Good) is shown in the upper-left corner of the view below the timestamp indicating when the last update was received.

Calibrating AHRS

The AHRS can be calibrated by tapping the AHRS Setting button in the attitude display, above the fullscreen button. This will activate Zero Pitch & Bank mode and a blue Save button will appear in the upper left corner of the display. Adjust your aircraft so that it is straight and level, tap the Zero Pitch & Bank button to zero the display, and tap the Save button to save the AHRS calibration.

Note: AHRS calibration should only be performed while in level, unaccelerated flight, or while stationary and level on the ground. Calibrating the device while accelerating or decelerating may result in errors in pitch and bank information.

3. Tap "Done" to save the calibration.

2. When aircraft is straight & level, and not accelerating, tap "Zero Pitch & Bank"

1. Tap to display "Zero Pitch & Bank"

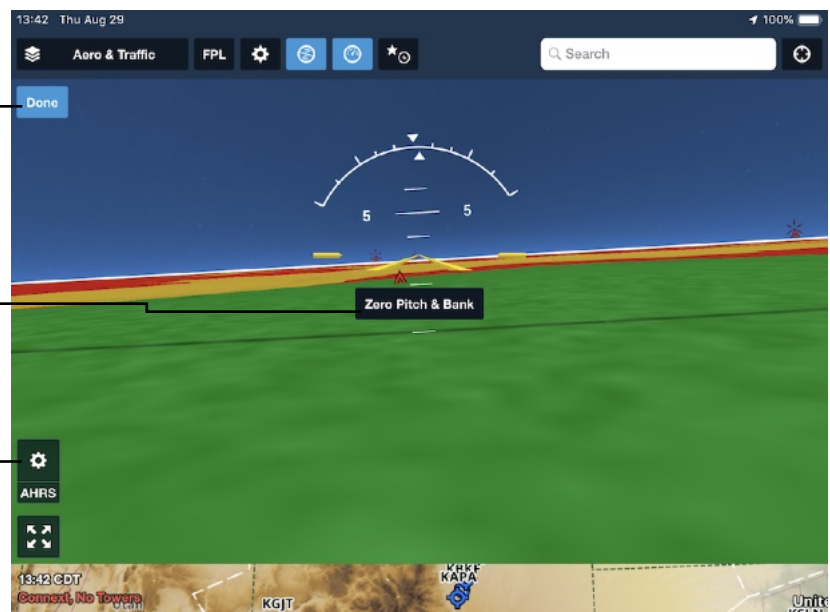

XM Weather Data (Garmin GDL 51, GDL 52, SiriusXM SXAR1)

ForeFlight Mobile can display these weather data items from the Garmin GDL 51, GDL 52, and SiriusXM SXAR1:

- ❖ High Resolution Composite (NEXRAD) Radar, including coverage of areas of southern Canada and northern Mexico
- ❖ High Resolution Lowest-tilt (NEXRAD) Radar, including coverage of areas of Canada and northern Mexico
NOTE: for either Composite or Lowest Tilt radars, see radar color vs. intensity legends for [Rain](#), [Mixed Rain/Snow](#), and [Snow](#).
- ❖ NEXRAD Storm Cell Attributes and track markers.
- ❖ Echo Tops, covering CONUS, northern Mexico, and southern Canada.
- ❖ Cloud Tops, covering CONUS, northern Mexico, and southern Canada.
- ❖ Icing NOWcast, covering CONUS, northern Mexico, and southern Canada.
- ❖ Freezing Level, covering CONUS, northern Mexico, and southern Canada.
- ❖ Turbulence, covering CONUS, northern Mexico, and southern Canada.
- ❖ Surface Analysis, covering almost all of North and Central America (excluding northernmost Canada and Alaska) and as far west as Hawaii.
- ❖ Surface Wind - derived from METARs at Airports, shows wind speed and direction at those locations only.
- ❖ [Surface Wind Analysis](#) - derived from a forecast model, shows wind speed and direction at 10 meters above the surface at tens of thousands of evenly spaced points across the country.
- ❖ [Surface Visibility](#) - shows near-term forecasts of surface visibility using colors to indicate visibilities ranging from 10 to 0 statute miles.
- ❖ Lightning
- ❖ Temporary Flight Restrictions (TFRs) on Maps **SEE IMPORTANT NOTICE BELOW**
- ❖ Winds Aloft — Graphical
- ❖ Temperatures Aloft
- ❖ Dewpoint spread
- ❖ METARs/TAFs
- ❖ AIRMETS/SIGMETS

- ❖ PIREPS
- ❖ Radar Coverage Map

TFRs IMPORTANT NOTICE:

While using one of these receivers, up-to-date graphical TFR information is ONLY displayed if you select the TFR Map layer.

However if the FAA publishes a TFR without associated graphical shape information it may not be possible for ForeFlight Mobile to show the graphical TFR on the Maps page.

Therefore you should also check the Airports page, under NOTAMs > TFRs for airports along your route, and contact ATC or FSS to confirm that your route does not cross any such TFRs

TFR data may not be updated or displayed if your iPad is “asleep”, is not connected to the receiver, if the receiver is not receiving data from XM satellites, or if the XM satellite data does not include information about that TFR.

Storm cell attributes show the height of the cell in 100’s of feet. Tap the marker to view details about the speed and direction of travel. Storm cell track markers show the projected direction of travel of the cell, and where it is projected to be in 20, 40, and 60 minutes from the time of the Radar update.

The storm cell track markers, storm cell attributes, and other weather symbols (see below) are all based on the latest Radar frame received, so do not animate if you tap the Radar ‘play’ button.

Tap on other weather symbol, such as Hail, to view additional details.

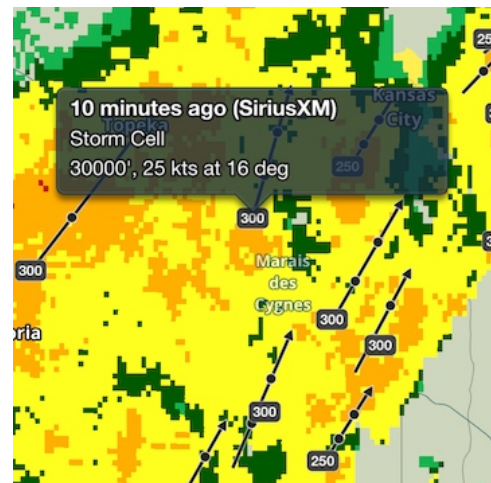

XM Freezing Level

The Freezing Level layer uses colored gradients (and when zoomed-in, altitudes in feet at the color borders) to depict the lowest altitude at which freezing and icing may occur across the continental U.S., southern Canada, and northern Mexico.

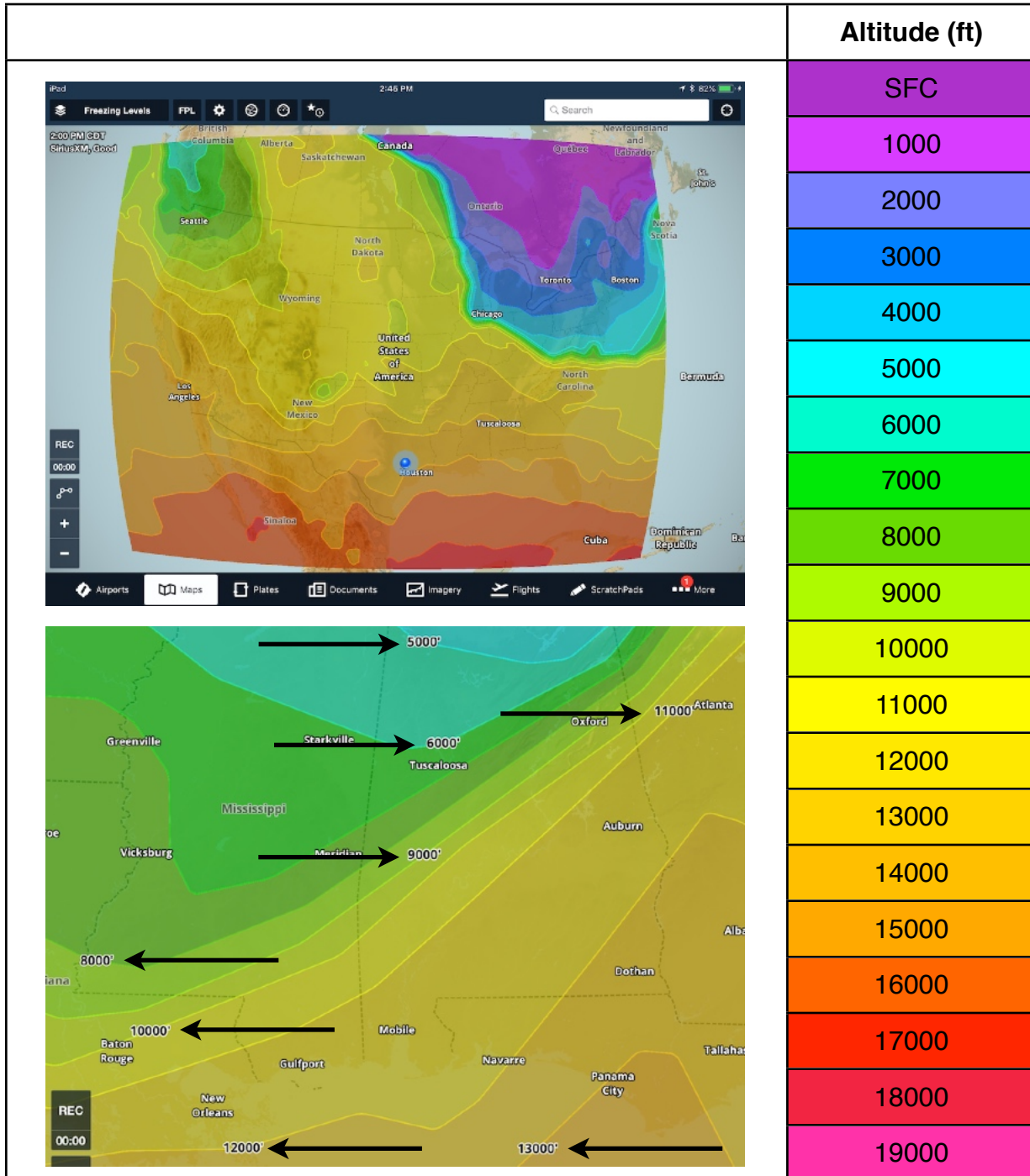

XM Surface Visibility

The XM Surface Visibility layer shows a near-term forecast of surface visibility using colors to indicate forecast surface visibilities ranging from 10 to 0 statute miles.

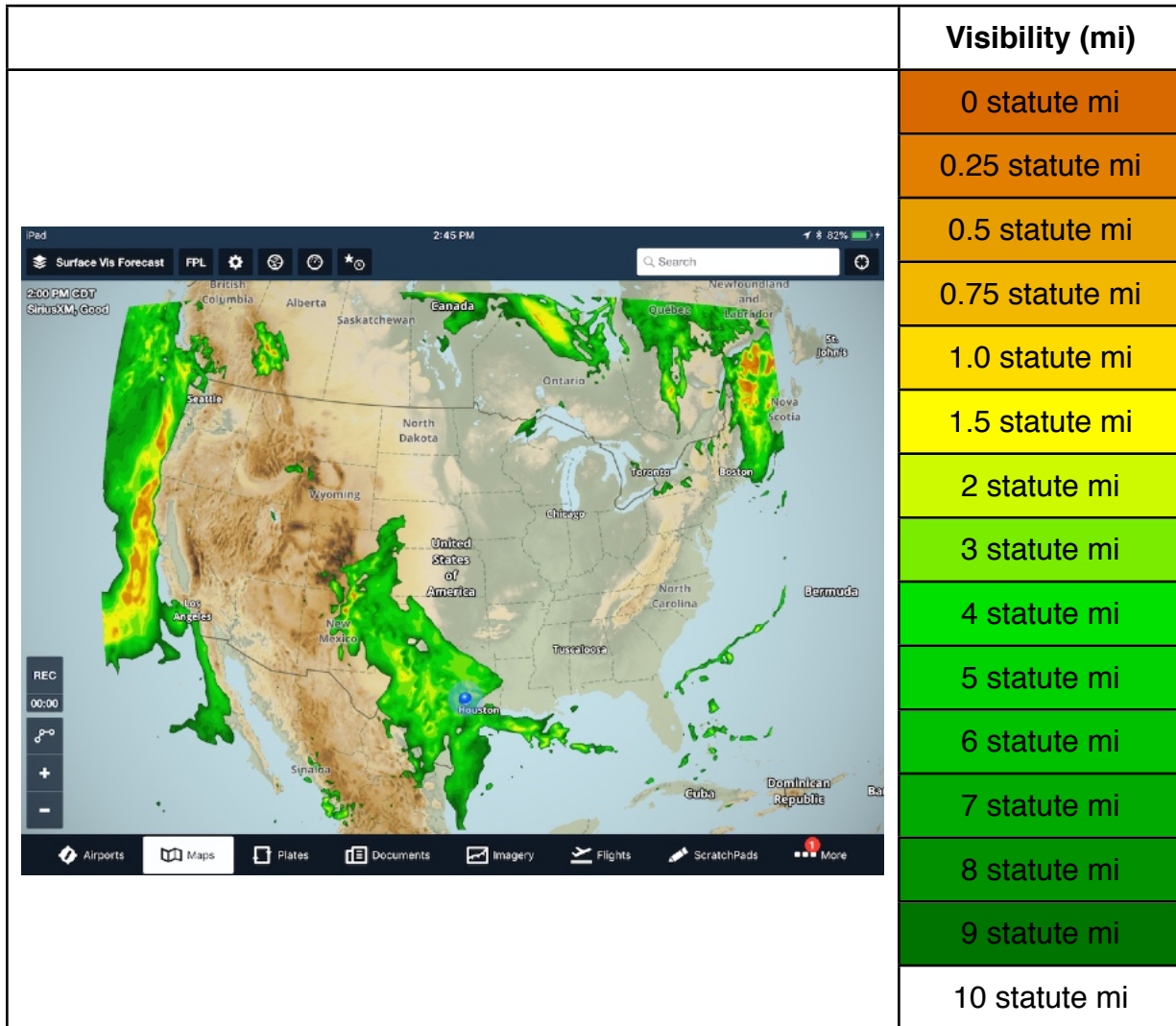

L-3 Lynx

ForeFlight can connect to L-3's Lynx line of ADS-B transceivers, including the NGT-9000, -2000, and -2500 models to receive ADS-B traffic and weather and GPS position via Wi-Fi in ForeFlight.

Connecting to Lynx

After the Lynx has been installed in your aircraft, open **Apple Settings** > **Wi-Fi** and select "LynxWi-Fi" to connect to the Lynx's Wi-Fi network. **NOTE:** ForeFlight can communicate with the Lynx regardless of the Lynx "Wi-Fi Dongle Application" port setting.

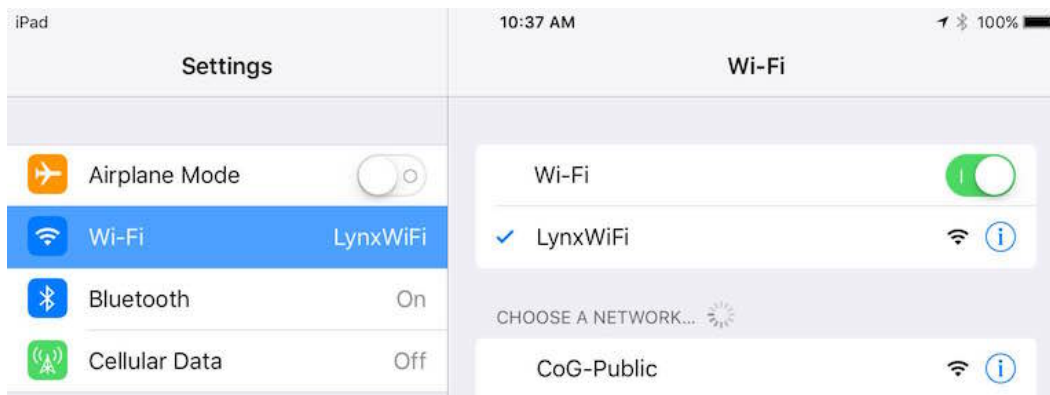

Using Lynx

Once you've joined the Lynx's Wi-Fi network, open ForeFlight and tap **More** > **Devices** to confirm the connection was recognized by ForeFlight and see what information is being received from the Lynx (see the note above if the Lynx is not appearing on this screen).

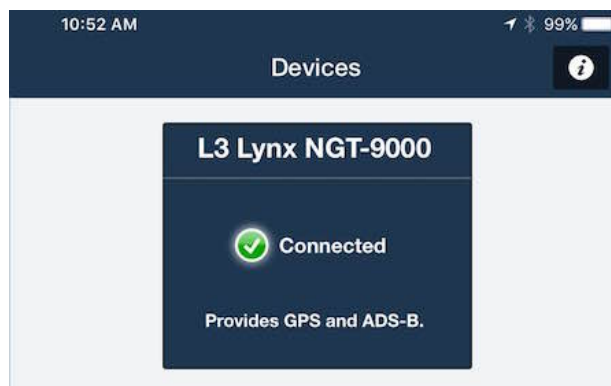

Tap the box to view the details of the Lynx and the data being received from it.

There are two settings that can be adjusted at the bottom of the Lynx status page:

- ❖ Logging - used only for diagnosing problems, this manages logging of the ADS-B data stream received by the Lynx. Leave this OFF normally, as it reduces app performance.
- ❖ Show ADS-B Towers - show the location on the Map of the ADS-B Towers currently being received.

GPS and ADS-B from Lynx

When GPS data is being sent from the Lynx to ForeFlight, the Accuracy instrument will show "Accuracy (L3 Lynx)." **NOTE:** Due to how ADS-B GPS accuracy is calculated and reported by the Lynx, the accuracy shown in ForeFlight may be worse than what it actually is. This is because the Lynx uses a limited number of "buckets" to report GPS accuracy to ForeFlight Mobile:

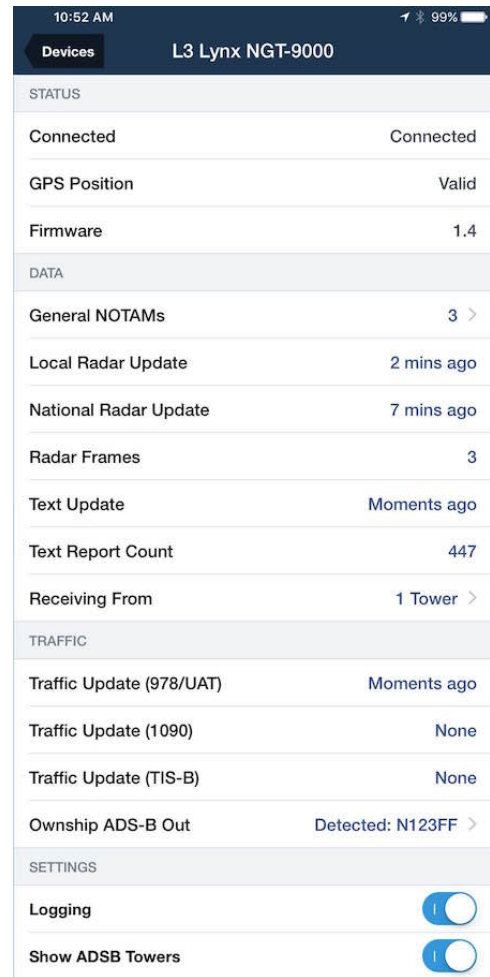

Lynx GPS Accuracy	GPS Accuracy shown in ForeFlight Mobile
Between 30m and >10m	30m
Between 10m and >3m	10m
3m or better	3m

When an ADS-B weather or traffic layer is selected on the Maps view, the [quality of the ADS-B signal being received](#) (No Towers, Marginal, Good) is shown in the upper-left corner of the view below the timestamp indicating when the last update was received.



Avidyne IFD 550/540/440

ForeFlight can connect to Avidyne’s IFD 550, 540, and 440 panel avionics via Wi-Fi to receive GPS position and flight plans sent to ForeFlight Mobile, and to send flight plans to the IFD 550/540/440. ForeFlight can also receive attitude information from the IFD 550 to power Synthetic Vision. ADS-B Weather and Traffic are supported when the IFD has firmware 10.2.3.1 or later, and an Avidyne-compatible ADS-B receiver is correctly connected to the Avidyne IFD.

Connecting to IFD 550/540/440

After the Avidyne device has been installed in your aircraft and powered on, open Apple Settings > Wi-Fi, select “LIO_Wi-Fi”, and enter the password to connect to the Avidyne’s Wi-Fi network.

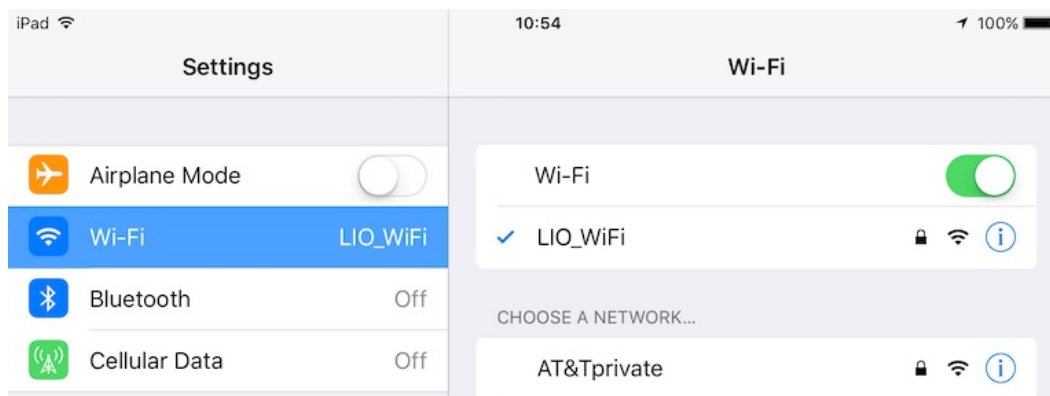

If you also have a Sentry ADS-B receiver (or other portable Wi-Fi-enabled ADS-B receiver) you can configure your IFD 550/540/440 into “Remote” Wi-Fi mode so it connects to the receiver’s Wi-Fi network, allowing your iPad to both receive ADS-B weather & traffic data directly from the Sentry, and to exchange flight plans with the IFD. NOTE: ADS-B data is not provided to the IFD by the portable ADS-B receiver.

See the detailed instructions in the IFD 550/540/440 manual; but in general the IFD must be placed into Maintenance mode, then changed to the Wi-Fi Configuration page. Use the knobs on the IFD to Enter the Sentry SSID. **IMPORTANT:** The SSID is case sensitive. To minimize the chance of error when entering the SSID, before starting note the exact spelling and capitalization of the SSID in your iPad’s or

iPhone's Apple Settings > Wi-Fi menu.

DO NOT enter a PSK. If you have [Stratus WPA2](#) turned ON, you must turn it OFF before completing this setup. Then change the IFD Wi-Fi mode to: Remote.

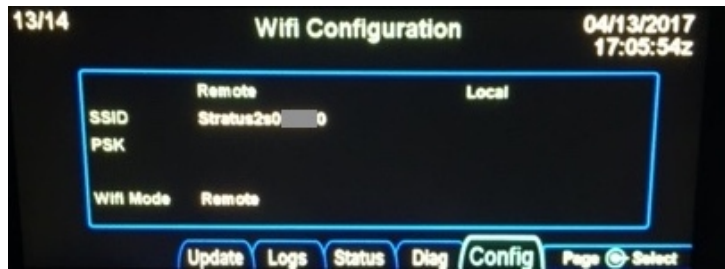

Getting a Route from IFD 550/540/440

Open ForeFlight and tap More > Devices to see the capabilities being provided by the Avidyne. Tap on the Avidyne IFD tile to open the Avidyne's status page.

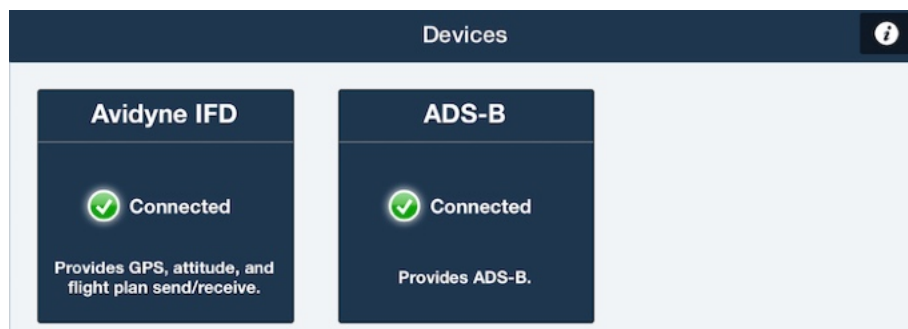

If a route is currently loaded in the Avidyne it will appear at the bottom of the status page under Route. Tap on it to load the route into ForeFlight.

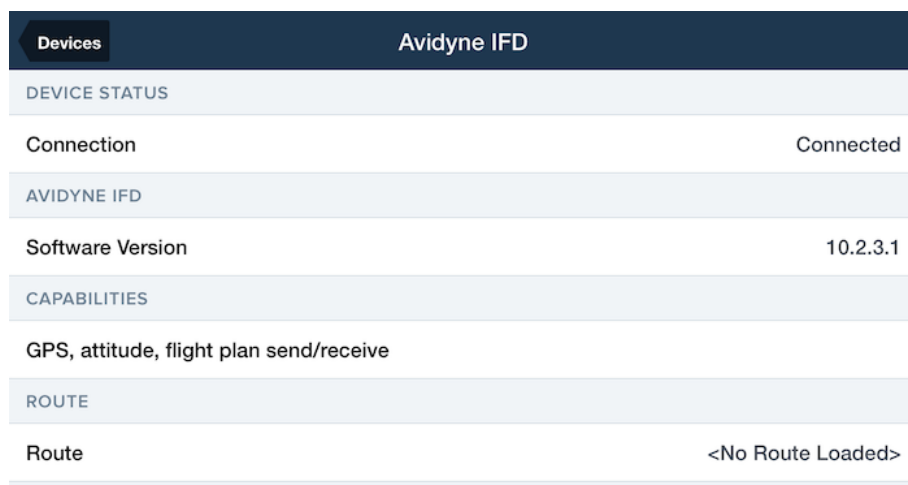

You can also load routes on an iPad from the Maps view: tap the Panel button at the top of the Maps view while connected to the Avidyne and tap "Load from Panel" to load the route into ForeFlight, and "Send to Panel" to send a route to the Avidyne.

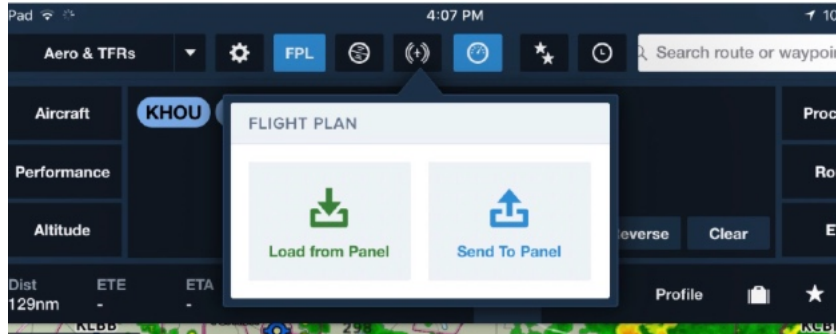

After tapping the "Send to Panel" button, on the Avidyne screen you will see a "Route Upload Ready" notification appear in the lower-right. Select the ROUTE page.

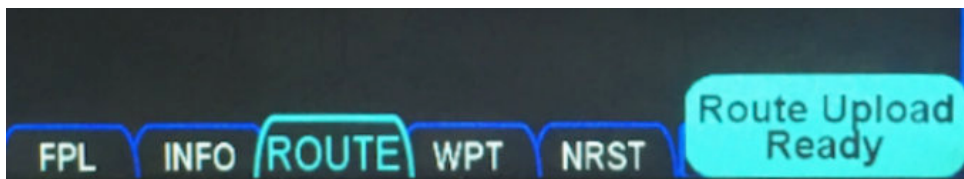

On the ROUTE page, search for your route in the list. The route may not be at the top of the list since routes are organized alphabetically by the "From" waypoint:

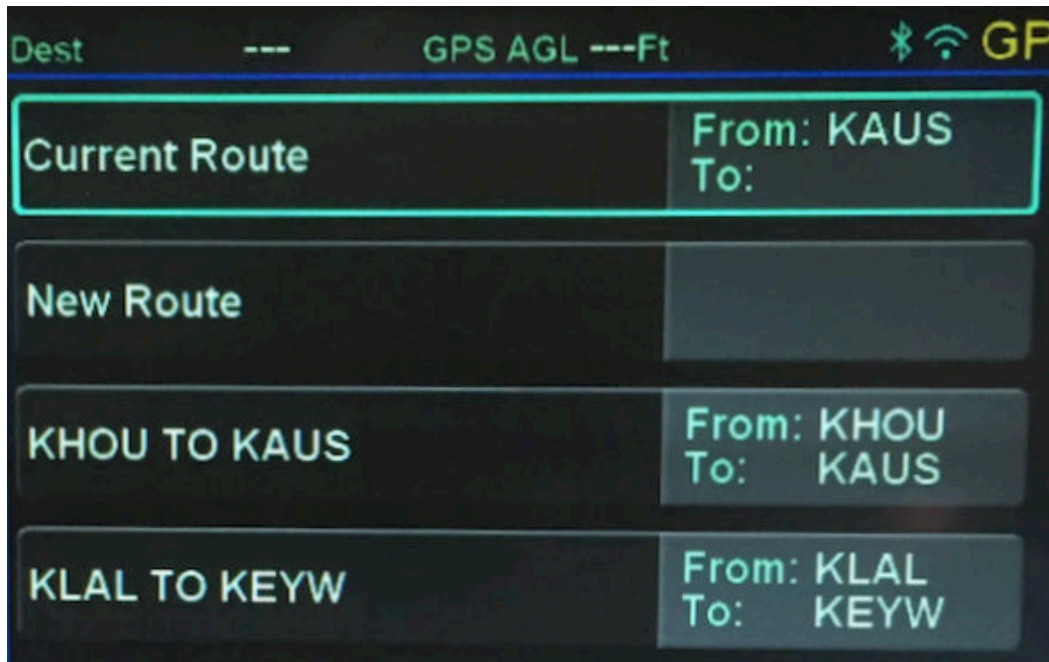

Select the route then choose the ACTIVATE ROUTE button on the left side of the screen. Confirm the route if you get a popup. You will now see the chosen route is activated on the Avidyne "FPL" page.

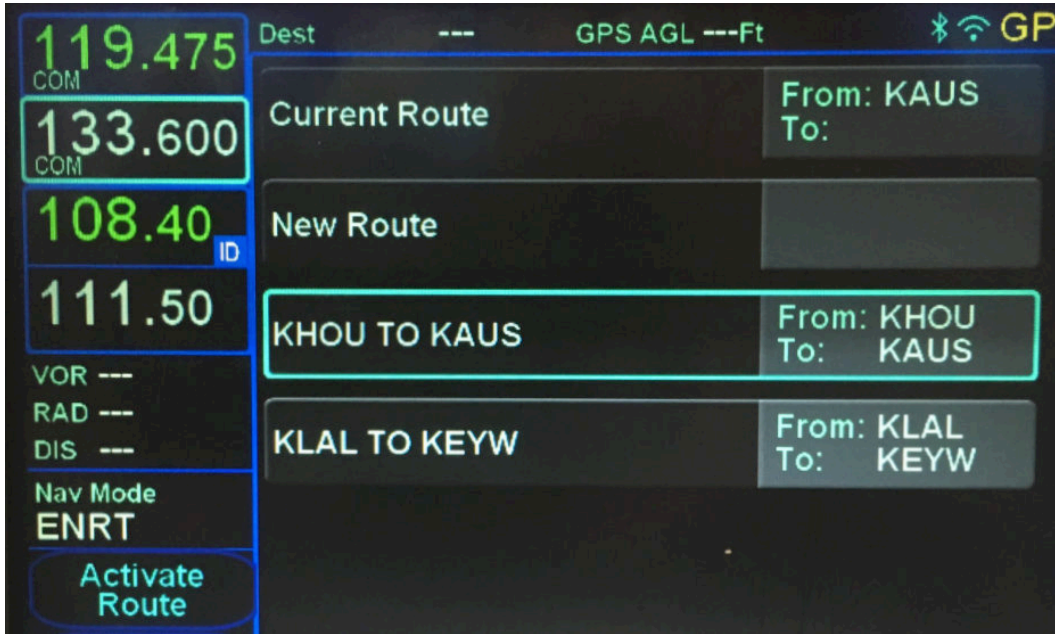

NOTE: If a route sent from the Avidyne contains waypoints not supported by ForeFlight Mobile they will appear in the app as Lat/Long waypoints:



GPS from IFD 550/540/440 and AHRS from IFD 550

When GPS data is being sent from the Avidyne to ForeFlight, the Accuracy instrument will show "Accuracy (Avidyne IFD540/440)", though some text will be cut out due to its length.



The AHRS data received from the IFD 550 can be used to power Synthetic Vision. The AHRS can only be calibrated within the IFD 550.

uAvionix echoUAT & SkyEcho

ForeFlight can connect to uAvionix's echoUAT and SkyEcho transceivers via Wi-Fi to receive ADS-B traffic and weather in ForeFlight, and the echoUAT also provides GPS position.

Connecting to echoUAT & SkyEcho

After either device has been installed in your aircraft, open **Apple Settings** > **Wi-Fi** and select "Ping-XXX" (where "XXXX" is some sequence of numbers and letters) to connect to the device's Wi-Fi network.

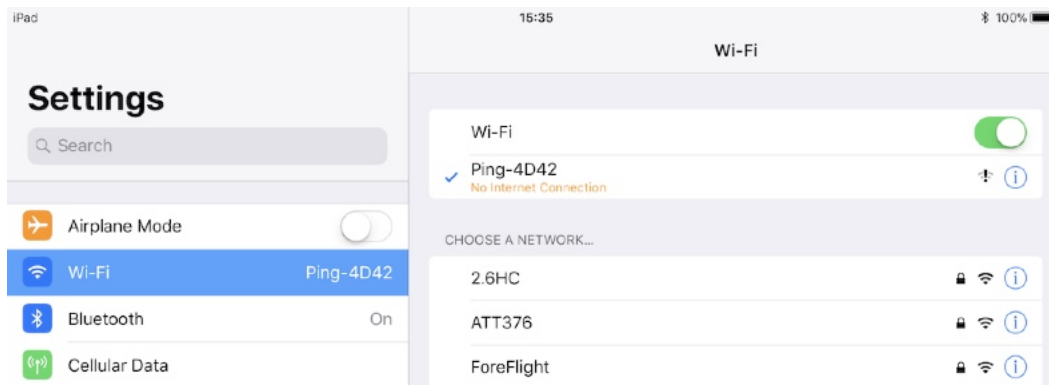

Using echoUAT & SkyEcho

Once you've joined the device's Wi-Fi network, open ForeFlight and tap **More** > **Devices** to confirm the connection was recognized by ForeFlight and see what information is being received from the device (both echoUAT and SkyEcho will appear as "uAvionix" in ForeFlight).



Tap the box to view the details of the device and the data being received from it.

There are three settings that can be adjusted at the bottom of the device's status page:

- ❖ Logging - used only for diagnosing problems, this manages logging of the ADS-B data stream received by the device. Leave this OFF normally, as it reduces app performance.
- ❖ Show ADS-B Towers - show the location on the Map of the ADS-B Towers currently being received.
- ❖ Use as GPS - turn ON to use the device's internal GPS to provide position data to ForeFlight. Turn this OFF if you'd rather receive GPS data from another connected device or from your iPad/iPhone's internal GPS.

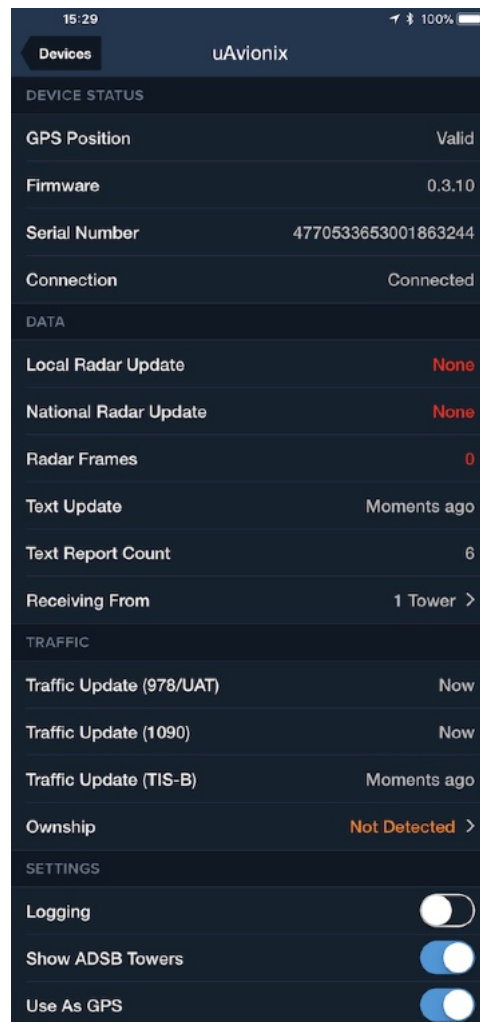

GPS and ADS-B from echoUAT & SkyEcho

When GPS data is being sent from the device to ForeFlight, the Accuracy instrument will show "Accuracy (uAvionix)." When an ADS-B layer such as Radar or Traffic is selected on the Maps view, the number of ADS-B towers being received by the device is shown in the upper-left corner of the view below the timestamp indicating when the last update was received.

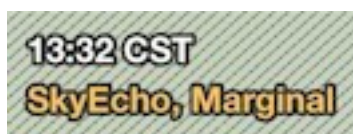

Dynon SkyView

ForeFlight has partnered with Dynon Avionics to bring secure Wi-Fi connectivity between ForeFlight Mobile and the Dynon SkyView glass panel avionics system. This connectivity allows flight plans to be transferred between ForeFlight Mobile and the SkyView, and for ForeFlight Mobile to receive GPS and AHRS data from the SkyView.

To connect your ForeFlight Mobile with your Dynon SkyView, you will need:

- ❖ A Dynon Wi-Fi adapter for each SkyView screen.
- ❖ SkyView version 12.0 or later in each SkyView screen.
- ❖ ForeFlight Mobile version 6.7 or later.

Configuring SkyView Wi-Fi

See the SkyView documentation for instructions on installing and configuring the SkyView Wi-Fi adapter and setting the network password.

Connecting ForeFlight and SkyView

With the SkyView system ON, open Apple Settings > Wi-Fi and tap the SkyView-XXXXX Wi-Fi network, then enter the password to connect.



IMPORTANT: If your iPad has the Cellular Data option it should be switched **OFF**. iPhones should have **Airplane Mode** switched **ON**, with **Wi-Fi** then turned back **ON**.

Sending a Route to SkyView

On an iPad, open the Flight Plan Editor, tap the “Send to” button and tap “Panel”, or tap the Panel button at the top of the Maps view and tap “Send to Panel.”

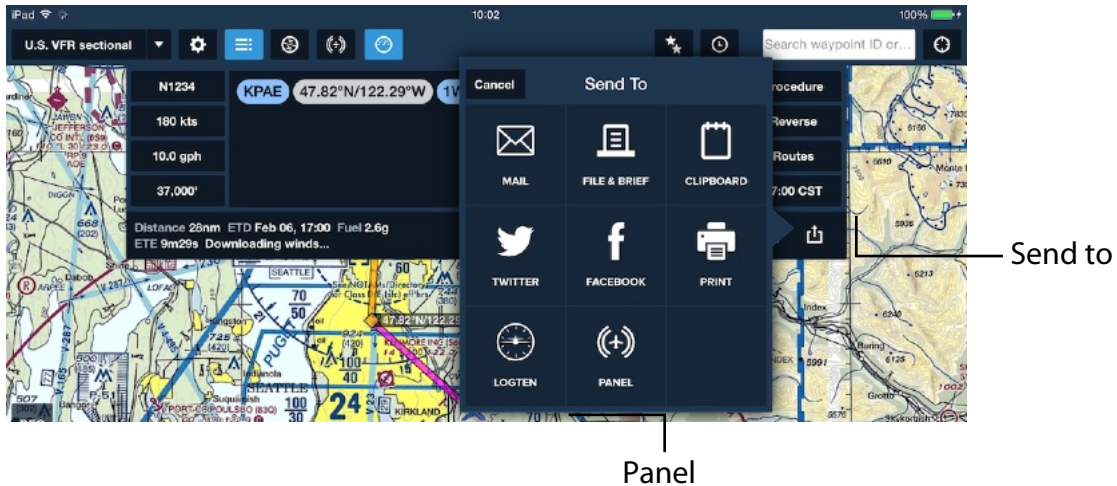

On an iPhone, tap Menu, scroll to the Route section and choose the Route. Then tap the “Send to” button in the bottom-right and tap “Panel.”

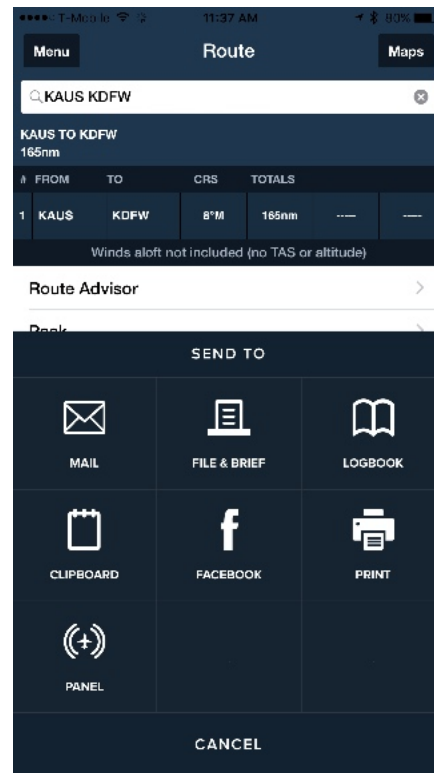
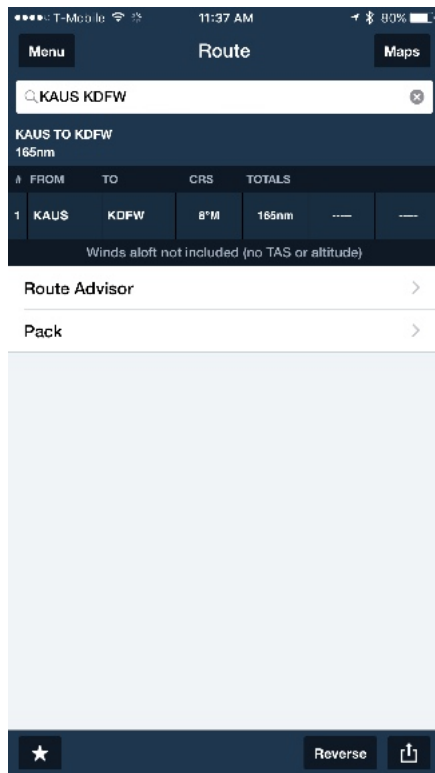

After sending the route a popup will open in ForeFlight confirming that the route has been successfully sent to the SkyView. Tap “OK” to dismiss the popup.

A popup will also open on the SkyView indicating that the route has been successfully received.

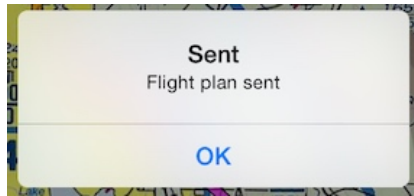

Getting a Route from SkyView

You can see if SkyView has a route available to send to ForeFlight Mobile in More > Devices > SkyView > Route; or on the Maps view, tap the Maps “Settings” button  and scroll to the bottom of the menu.

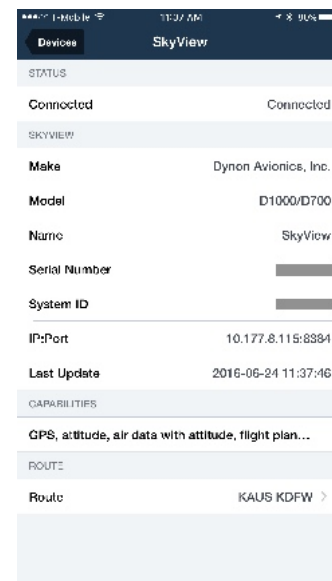
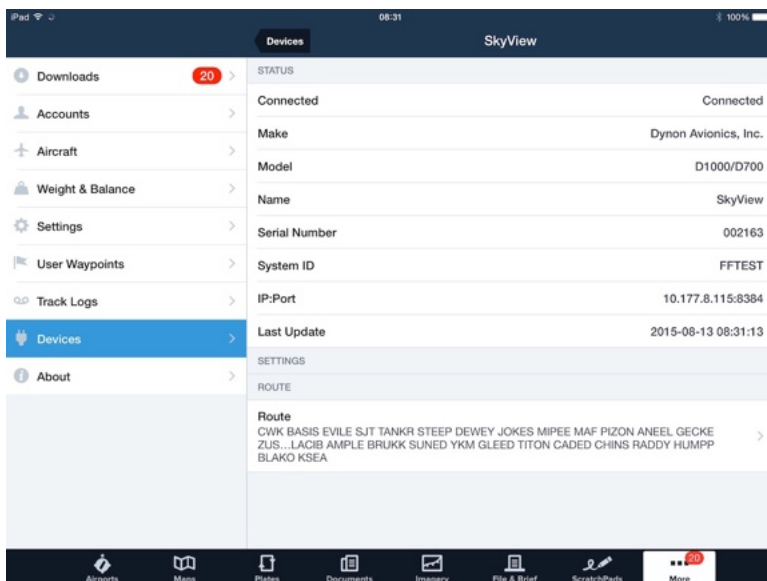

To transfer a route from a SkyView to an iPad, tap the “Panel” button at the top of the Maps view and tap “Load from Panel.” You can also load a route shown on the SkyView status page in More > Devices > SkyView by tapping the route.



On an iPhone, tap More > Devices > SkyView then tap the Route to load it into the Route Editor.

GPS and ARHS data from SkyView

When GPS data is being sent from the SkyView to ForeFlight Mobile, the Accuracy instrument will show "Accuracy (SkyView)."

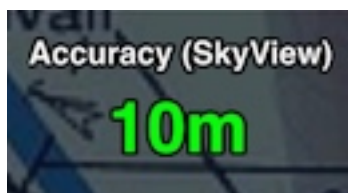

When AHRS data is being sent from SkyView to ForeFlight Mobile, the ARHS source (displayed by tapping the "Gear" button above "AHRS") will show as SkyView.

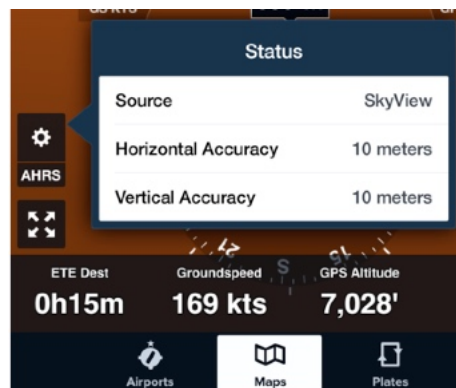

ForeFlight Mobile will be receiving the same AHRS data as is displayed on the SkyView screen(s) so no additional AHRS calibration is necessary in ForeFlight Mobile.

FreeFlight ADS-B

FreeFlight can receive ADS-B weather and Traffic data, as well as GPS position data from appropriately-equipped FreeFlight RANGR ADS-B systems.

Connecting FreeFlight and FreeFlight RANGR

After connecting to the FreeFlight RANGR Wi-Fi network using Apple Settings > Wi-Fi, tap More > Devices to confirm the FreeFlight box is displayed.

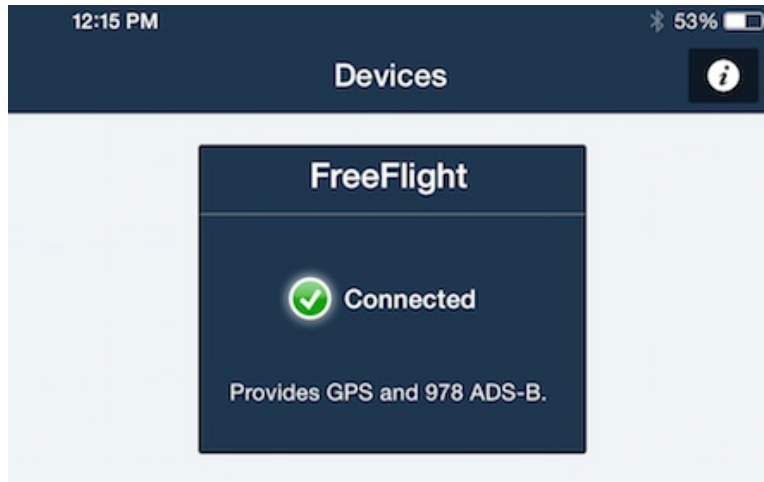

Tap the FreeFlight box to see detailed information and settings for the FreeFlight RANGR.

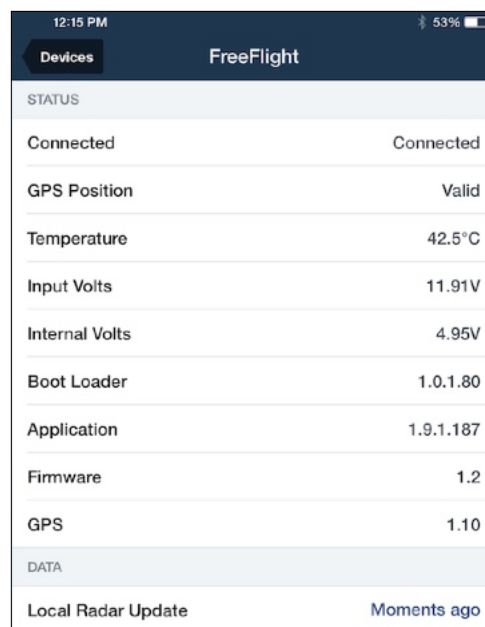

STATUS	
Connected	Connected
GPS Position	Valid
Temperature	42.5°C
Input Volts	11.91V
Internal Volts	4.95V
Boot Loader	1.0.1.80
Application	1.9.1.187
Firmware	1.2
GPS	1.10
DATA	
Local Radar Update	Moments ago

GPS and ADS-B data from FreeFlight RANGR

When GPS data is being provided by the RANGR, the Accuracy instrument will show (FreeFlight).

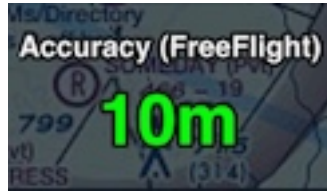

When an ADS-B layer such as Radar or Traffic is selected on the Maps page, the number of ADS-B towers being received by the FreeFlight RANGR is shown in the upper-left corner of the page below the timestamp indicating when the last update was received.

SiriusXM SXAR1

ForeFlight Mobile supports the SiriusXM SXAR1 portable, battery-powered weather receiver when used with a “Pilot for ForeFlight” SiriusXM weather data subscription. To purchase that subscription from SiriusXM, call SiriusXM Aviation at 1-855-838-8563 or visit www.siriusxm.com/foreflight.



Connecting ForeFlight to the SXAR1

The SXAR1 uses Bluetooth to connect to a single iPad or iPhone at a time; simultaneous connections to multiple iPads or iPhones are not currently supported.

To pair your iPad or iPhone with SXAR1 turn the SXAR1 ON and once the lights on top start to illuminate, open Apple Settings and go to the Bluetooth section.

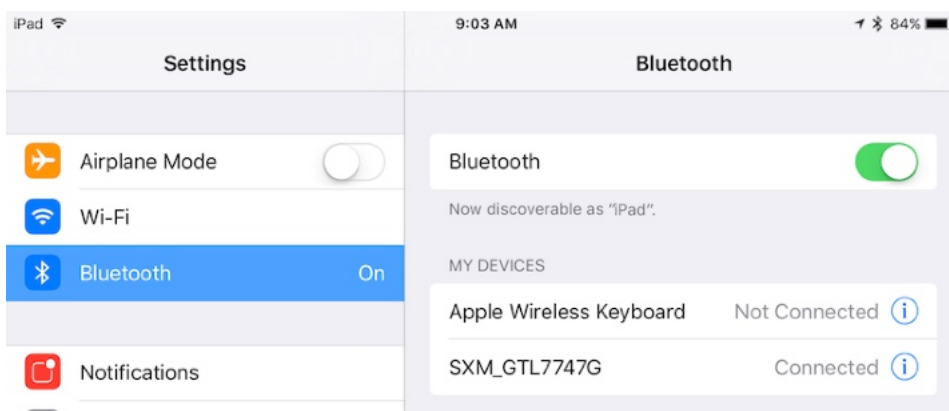

Tap the SXM_##### entry to pair with your iPad. NOTE: The letters and numbers after “SXM_” in the list of Bluetooth devices are your RadioID, which may be needed when subscribing, re-activating, or resetting your “Pilot for ForeFlight” SiriusXM weather data subscription.

XM Weather Data

See [XM Weather Data](#) for details of the weather data available in ForeFlight Mobile when connected to a SiriusXM SXAR1.

SXAR1 Status Information

Tap More > Devices > SXAR1, or from the Maps page tap the Maps Settings (gear) button and scroll down to SXAR1, to see device status and settings.

There are four settings that can be adjusted at the bottom of the SXAR1 status page:

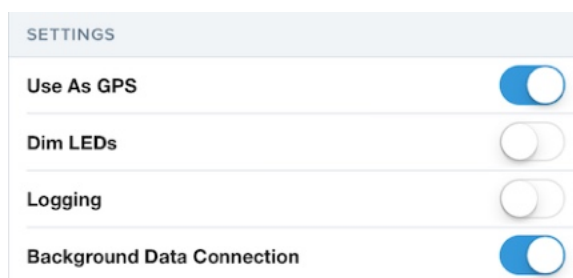

- ❖ Use as GPS - turn ON to use the SXAR1’s internal GPS to provide position data to ForeFlight. Turn this OFF if you’d rather receive GPS data from another connected device, such as a Sentry
- ❖ Dim LEDs - turn ON to dim the SXAR1’s status lights, which helps preserve battery life and reduces brightness when flying at night.
- ❖ Logging - used only for diagnosing problems, this manages logging of XM data stream received by SXAR1. Leave this OFF normally, as it reduces app performance.
- ❖ Background Data Connection - when ON, SXAR1 will continue to send updated weather data to ForeFlight even when it is in the background. We recommend leaving this ON, because turning it OFF can result in the loss of Bluetooth connection to SXAR1 if ForeFlight is kept in the background.

SiriusXM Satellite Radio

With a SiriusXM Satellite Radio subscription, an add-on to the “Pilot for ForeFlight” SiriusXM weather data subscription, you can listen to SiriusXM radio while in-flight via a Bluetooth audio device. This can be a single headset with Bluetooth audio, or an

intercom with Bluetooth audio interface, or a Bluetooth audio adapter plugged-in to a “music-in” jack in your aircraft’s panel and wired-in to the intercom.

IMPORTANT: the SiriusXM satellite radio does NOT play directly through the iPad or iPhone speaker or headphone jack. You MUST connect a Bluetooth audio device per the instructions below.

Playing a satellite radio stream is controlled by the interface in ForeFlight Mobile, but the audio is sent directly from the SXAR1 to the Bluetooth audio device. This means the audio will continue to play if you sleep ForeFlight Mobile.

To add SiriusXM Audio to your existing subscription, call 855-838-8563 or visit https://care.siriusxm.com/login_view.action to upgrade. For more information about the “Pilot for ForeFlight” plan, visit <https://www.siriusxm.com/foreflight>.

After adding the subscription to your plan, you will see “Audio: Active >” below the ForeFlight subscription in More > Devices > SXAR1.

DEVICE INFORMATION	
Radio ID	GTL7747B
Subscription	ForeFlight
Audio	Active >

If “Active” does not show, position the SXAR1 so it has a clear view of the sky, then send a refresh signal to your radio by visiting <http://www.siriusxm.com/refresh>.

Connecting a Bluetooth audio device to the SXAR1

To listen to satellite radio programming you must connect a Bluetooth audio device to the SXAR1. To begin the connection process, tap More > Devices > SXAR1 > Audio, or on the Maps page tap the Maps Settings button, then scroll down to the SXAR1 and tap the "Audio >" line.

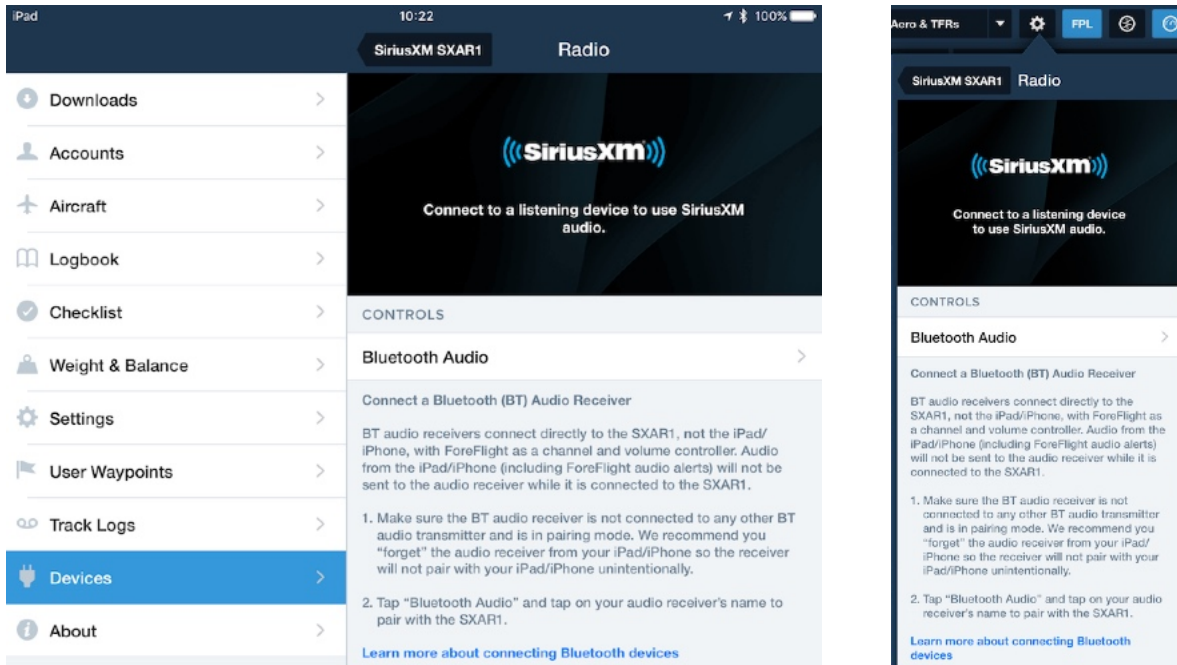

To connect to a Bluetooth audio device for the first time, turn it on and make sure it is in pairing mode. If that Bluetooth audio device was previously paired to your iPad or iPhone, you should "forget" that pairing in Apple Settings so that the device will be available to connect to the SXAR1. **NOTE:** many Bluetooth audio devices automatically enter pairing mode when first turned-on, as long as no other previously-paired devices are nearby.

Once the Bluetooth audio device is on and in pairing mode, tap "Bluetooth Audio" to initiate the connection from the SXAR1 to the Bluetooth audio device.

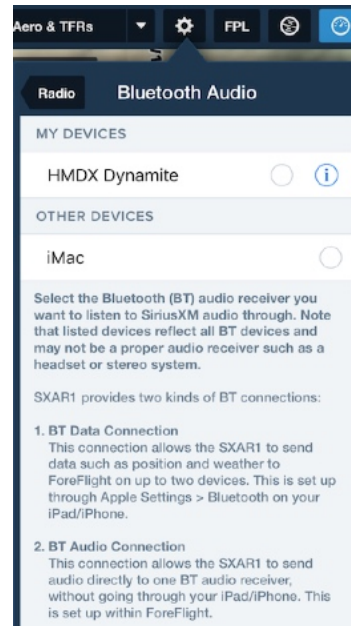
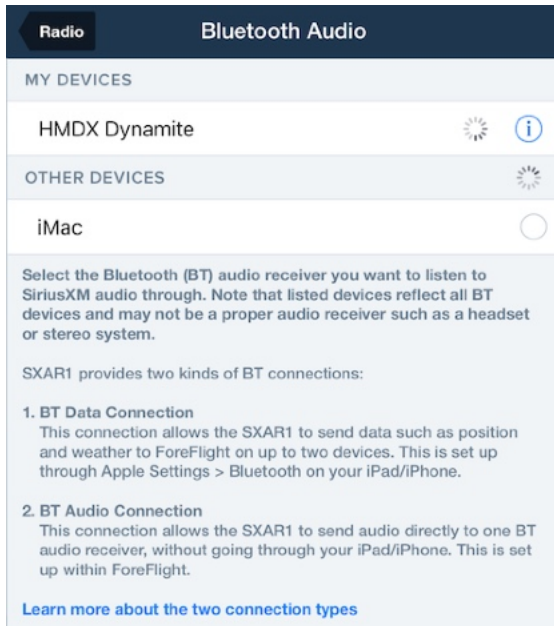

Tap the name of the device to which you would like the SXAR1 to connect. The “spinner” will appear and when the pairing is complete, the connected device will show in the “My Devices” section and audio should begin playing. To disconnect the device, or to forget it completely (which would require re-pairing) tap the “i” next to the device name, then choose the desired option.

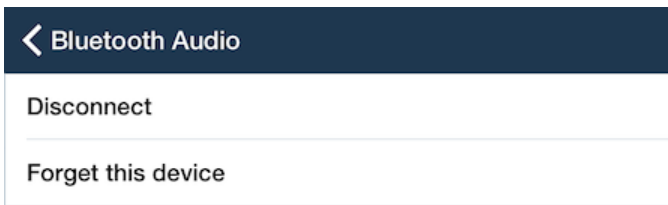

SXAR1 Audio Controls

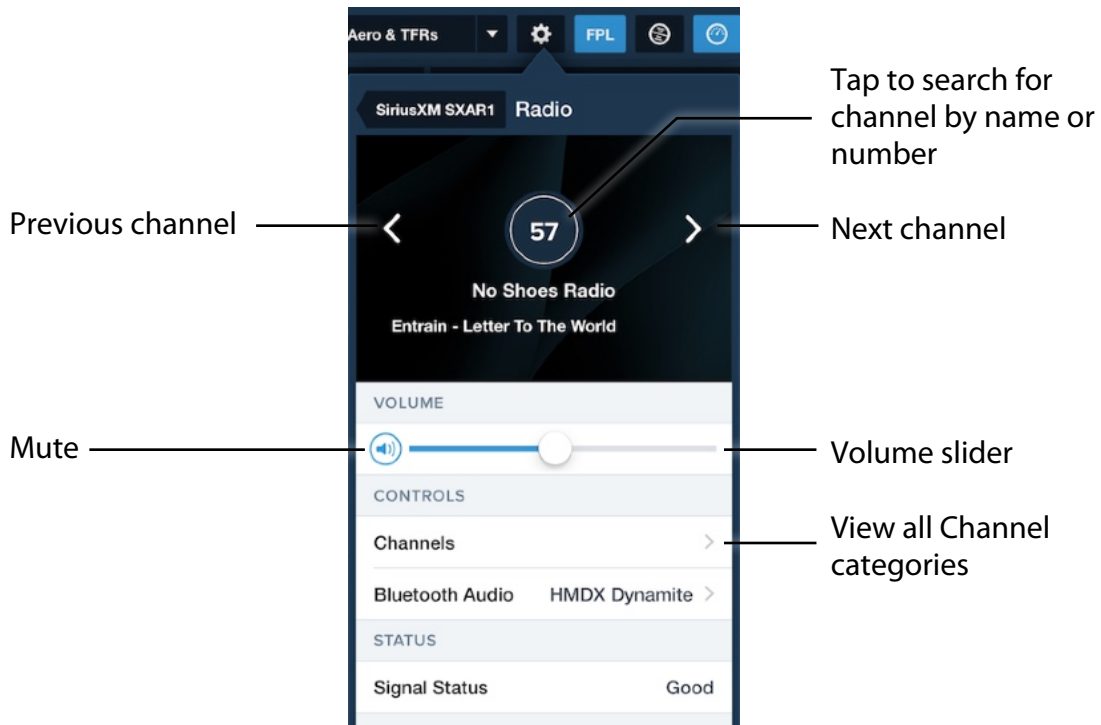

You can tune to a new channel by tapping the Category then Channel, or by typing the Channel number or name (full or partial) in the "Tune or Search" box. A vertical scroll bar shows when there are more Channels or Categories than can be shown, and blue speaker icon shows in the currently-playing Category and Channel.

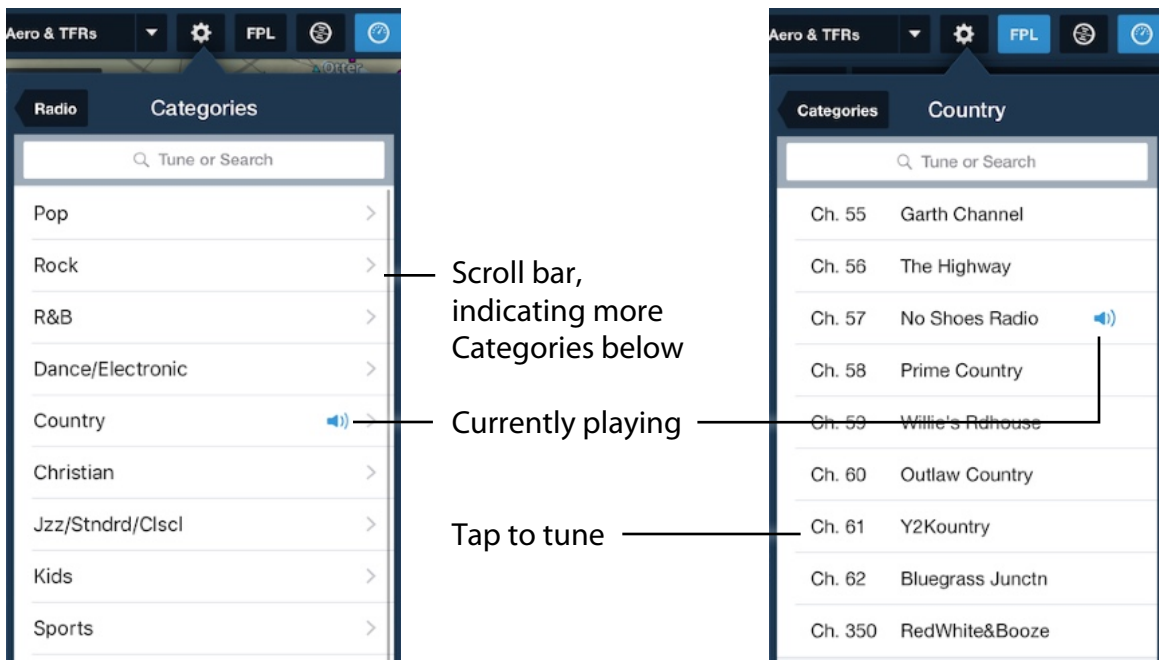

Search by Channel name or number

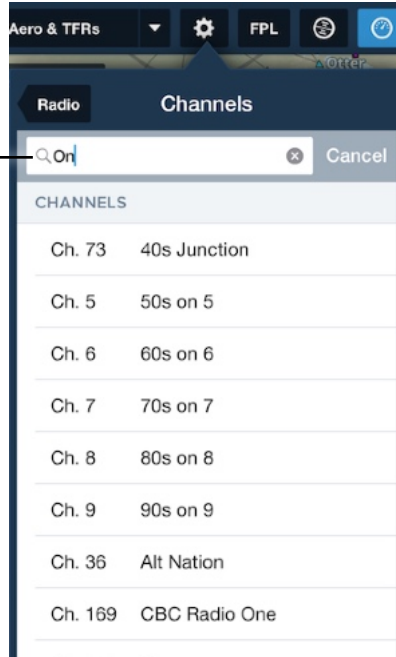

For additional information about ForeFlight's support for SiriusXM Satellite Radio and troubleshooting tips, visit <https://foreflight.com/connect/siriusxm/support/>.

Baron Mobile Link/WXWorx

The Baron Services Mobile Link plugs-in to a WXWorx XM WX receiver, and provides a Wi-Fi connection so that ForeFlight Mobile can access the XM WX data. Please consult the Mobile Link documentation to learn how to setup and connect the device.

The Mobile Link firmware 2.0 or higher allows data access to up to 4 devices at a time. ForeFlight Mobile attempts to get data access whenever it is launched and again any time data is requested by the user. ForeFlight Mobile will release its access when the app is closed via the physical home button.

If a device or app has gained access to the data and does not release it properly, the Mobile Link will automatically release the access for that device after 60 seconds.

The Mobile Link status view in ForeFlight Mobile will state whether data access has been obtained, see the “Status information” section below for more information.

Mobile Link Available Weather Data

ForeFlight Mobile can display these weather data items from the Baron Mobile Link/WXWorx:

- ❖ Radar - for any subscribed region, shown on Maps. See [radar color vs. intensity legend](#).
- ❖ Satellite - for any subscribed region, shown on Maps
- ❖ METARs and METAR-derived data shown on Maps, such as temperature
- ❖ TAFs
- ❖ Winds Aloft
- ❖ TFRs on Maps **SEE IMPORTANT NOTICE BELOW**
- ❖ PIREPs on Maps
- ❖ AIRMETs/SIGMETs on Maps
- ❖ Lightning on Maps (requires Mobile Link firmware version 2.0 or higher)

Data is accessed just as it is when on the ground using an Internet connection. There is no user-configuration required beyond ensuring the Wi-Fi connection to the Mobile Link is properly established.

TFRs IMPORTANT NOTICE:

While using a Baron Mobile Link XM WX receiver, up-to-date graphical TFR information is ONLY displayed if you select the TFR Map layer.

However if the FAA publishes a TFR without associated graphical shape information it may not be possible for ForeFlight Mobile to show the graphical TFR on the Maps page.

Therefore you should also check the Airports page, under NOTAMs > TFRs for airports along your route, and contact ATC or FSS to confirm that your route does not cross any such TFRs

TFR data may not be updated or displayed if your iPad is “asleep”, is not connected to the Baron Mobile Link, if the Baron Mobile Link receiver is not receiving data from XM satellites, or if the XM satellite data does not include information about that TFR.

Mobile Link Status Information

To learn the status of the Mobile Link connection, subscription, data availability and more, please use the Devices view as described above. When connected to the Mobile Link Wi-Fi access point, Mobile Link will be an option shown in the Devices view. Tap it to see full status information. This information is useful for troubleshooting if you experience problems with the Baron Mobile Link/WXWorx combination.

Satcom Direct Router (SDR) or SDR Gateway

All customers can connect to Satcom Direct Router or SDR Gateway to receive in-flight internet data in ForeFlight, but customers with a Performance Plus or Business Performance plan can also receive GPS and indicated altitude, in addition to having more control over the device's internet settings.

Connecting to Satcom Direct Router or SDR Gateway

To connect to the SDR's Wi-Fi network, open **Apple Settings** > **Wi-Fi** and select "SDR-XXX", where "XXX" is the router's serial number.

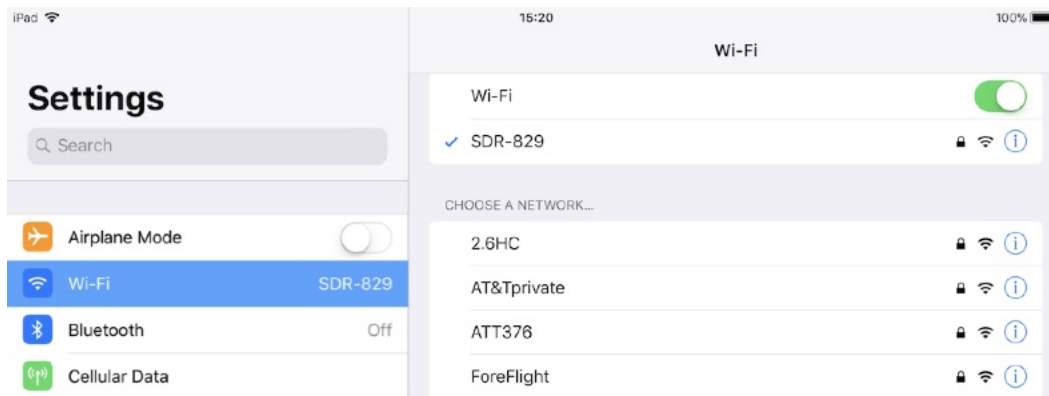

Using Satcom Direct Router or SDR Gateway

Once you've joined the Wi-Fi network, open ForeFlight and tap **More** > **Devices** to confirm the connection was recognized by ForeFlight and see what information is being received from the Satcom Direct device.

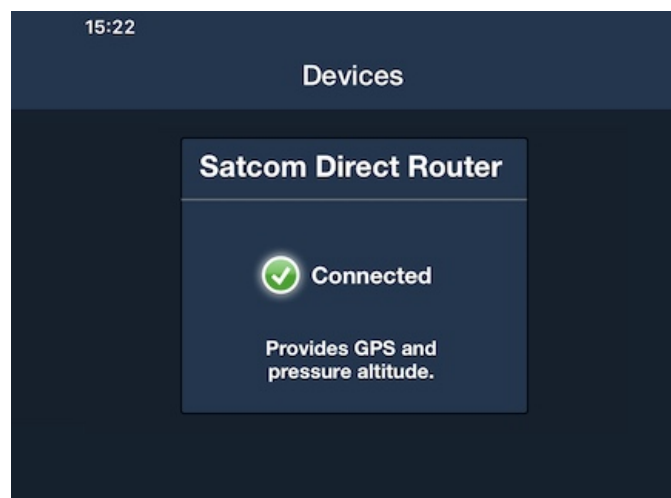

Tap the box to view details about the data being received from it.

There are settings that can be adjusted at the bottom of the status page:

- ❖ Allow ForeFlight to access the Internet - turn this OFF to prevent ForeFlight from using internet data from the SDR, reducing inflight bandwidth usage and associated costs. This setting is ON by default.
- ❖ Logging - used only for diagnosing problems, this manages logging of the data stream received by the SDR. Leave this OFF normally, as it reduces app performance.
- ❖ Use as GPS - turn ON to use your aircraft's GPS data routed through the SDR to provide position data to ForeFlight. Turn this OFF if you'd rather receive GPS data from another connected device or from your iPad/iPhone's internal GPS. **NOTE:** the SDR supplies GPS lat/long and groundspeed data, but it may not provide GPS altitude or GPS track, depending on the SDR's firmware.

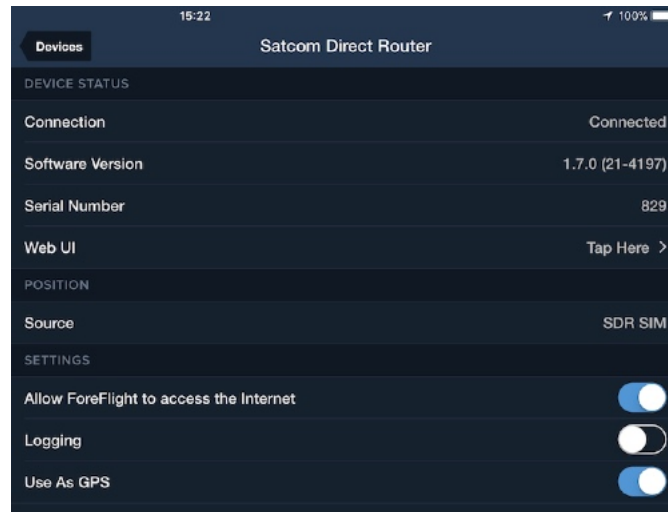

Tap the "Web UI" line to access the SDR LAN network administrator page on Safari.

GPS and Pressure Altitude from SDR

When GPS data is being sent from the SDR to ForeFlight, the Accuracy instrument will show "Accuracy (A429)". When Pressure Altitude data is being sent from the SDR to ForeFlight, the Pressure Altitude instrument will say "Pressure Altitude (A429)", and will have a "Indicated" tag underneath, indicating that the value represents actual indicated altitude.

DAC International GDC64

ForeFlight Mobile 11.10 and later support receiving GPS position and ADS-B data from a properly configured GDC64 with firmware version 7.0.A or later. See <http://dacint.com/products/gdc64> for more information.

The GDC64 will appear with 2 “tiles” in the More > Devices view:

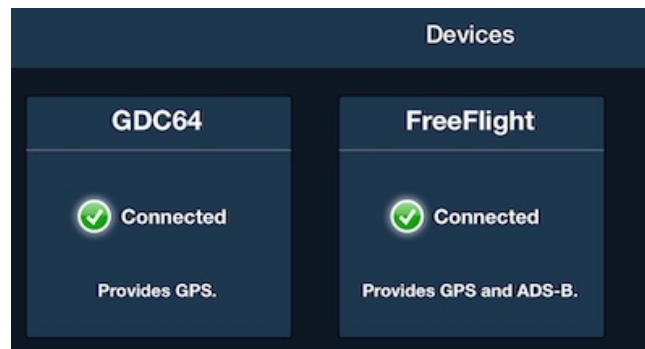

uAvionix SkyEcho 2 FLARM traffic (Europe-only)

ForeFlight Mobile 11.5 and later support displaying FLARM traffic (available in Europe) from the uAvionix SkyEcho 2. Viewing FLARM traffic in ForeFlight Mobile requires an app-specific FLARM decoding license, which can be purchased as an add-on to your ForeFlight subscription plan. You can add the FLARM license for ForeFlight Mobile at <https://www.foreflight.com/pricing> (enter your email address then proceed to the next page) or sign-in to your account at <https://plan.foreflight.com> and click “Upgrade or Renew My Subscription.” NOTE: FLARM decoding licenses cannot be transferred between devices or apps, so you’ll need a ForeFlight-specific license even if you already have a FLARM license for another app or display.



If you connect to a SkyEcho 2 and activate FLARM mode via the SkyEcho 2 Web UI but do not yet have a ForeFlight Mobile FLARM decoding license, you'll see the "License required..." tile on the More > Devices page. The next time your iPad connects to the Internet after this tile is displayed, your ForeFlight Mobile app will notify the ForeFlight servers and you'll receive a personalized email with instructions for adding the FLARM decoding license to your ForeFlight subscription.

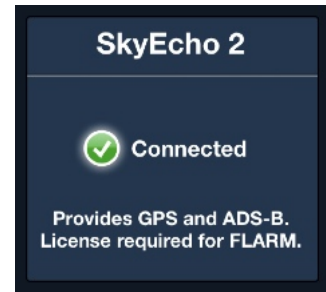

After you've added the FLARM decoding license to your ForeFlight subscription, the next time you open the app while connected to the SkyEcho 2 you'll see the updated tile. You can tap on the "SkyEcho 2" tile to see details about the SkyEcho 2 device and the data being received.

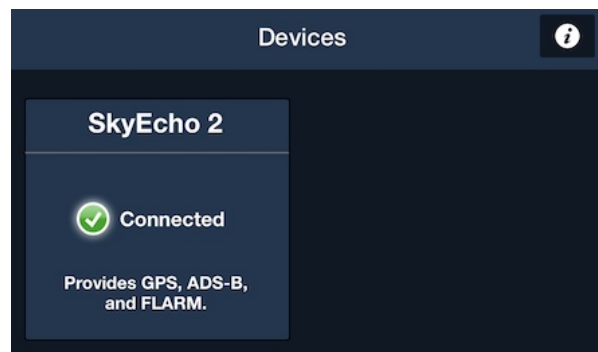

FLARM via NMEA (Europe-only)

Beginning with ForeFlight Mobile 11.7, ForeFlight Mobile can display FLARM traffic information delivered via the NMEA protocol. An adapter (typically Wi-Fi) is required to convert NMEA data into a format that can be received by the iPad.

Other Third-Party Devices

Beginning with ForeFlight Mobile version 10.0, ForeFlight Mobile provides an extension of the industry-standard GDL90 Data Interface Specification for third-party devices to transmit live ADS-B weather and traffic, AHRS, device name, and GPS data to ForeFlight Mobile.

ForeFlight does not test or provide support for devices that use this specification. If you experience problems with a device that uses this specification, please contact the device manufacturer for assistance.

For more information, please see the GDL90 Extended Specification at:
<https://www.foreflight.com/connect/spec/>

LogTen Integration

ForeFlight Mobile can export routes or flight plans to the LogTen app, when LogTen is installed. To create a new logbook entry in LogTen based on a route, create the route on the Maps view and tap the **Send To** button in the Navigation Log. This will show LogTen as one option. Tap that to open LogTen and create a new log entry.

Logbook entries can also be created from the Flights view, once LogTen is installed on the iPad. Run ForeFlight Mobile, go to Flights and select the plan to export. Tap the blue LogTen button below the flight plan details list on the right to open LogTen with a new logbook entry.

Flight Simulator Integration

Before Using a Flight Simulator with ForeFlight Mobile

The iPad (or iPhone) running ForeFlight Mobile must be on the same network as the flight simulator. Both the iPad running ForeFlight Mobile and the flight simulator can be connected to the network using Wi-Fi, or the flight simulator computer can be connected to the Wi-Fi router via Ethernet cable, while the iPad is connected via Wi-Fi.

After setting-up a compatible flight simulator and activating its data connection (see below for instructions for popular flight simulators) open ForeFlight Mobile, tap **More > Devices**, then tap on the box containing the name of the flight simulator and slide the “Enabled” switch to ON.

For example if using Infinite Flight, in ForeFlight Mobile tap **More > Devices**, then tap the “Infinite Flight” box, then switch the Enabled switch ON:

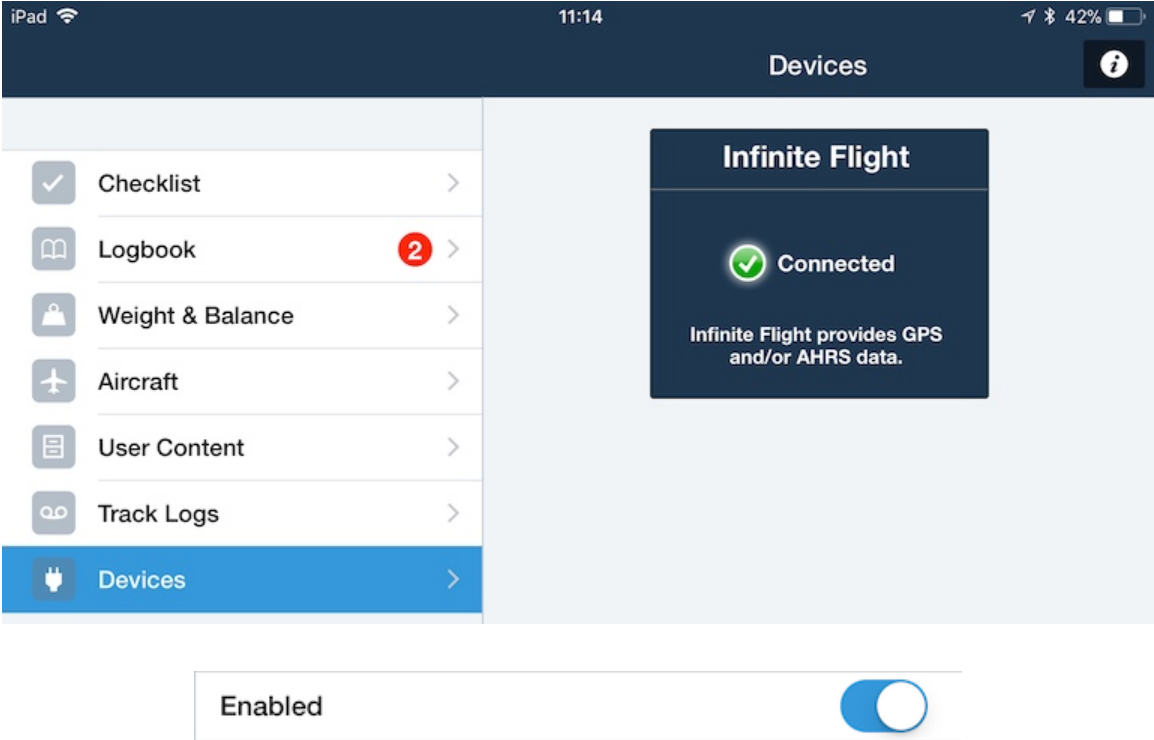

After connecting the flight simulator and turning the Enabled switch ON, verify that the iPad or iPhone is receiving simulated GPS data from the flight simulator by displaying the Accuracy instrument on the Instrument Panel on the Maps page.

X-Plane

ForeFlight Mobile can receive GPS input from the X-Plane flight simulator v10.11 or newer on any supported platform. To enable this feature in X-Plane v11 or later, bring up the **Settings** > **Network** menu in the upper-right of the menu-bar.

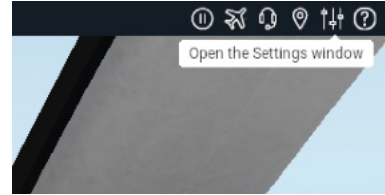

Then click on the “iPhone & iPad” category and check the appropriate ForeFlight Broadcast or Transmit box.

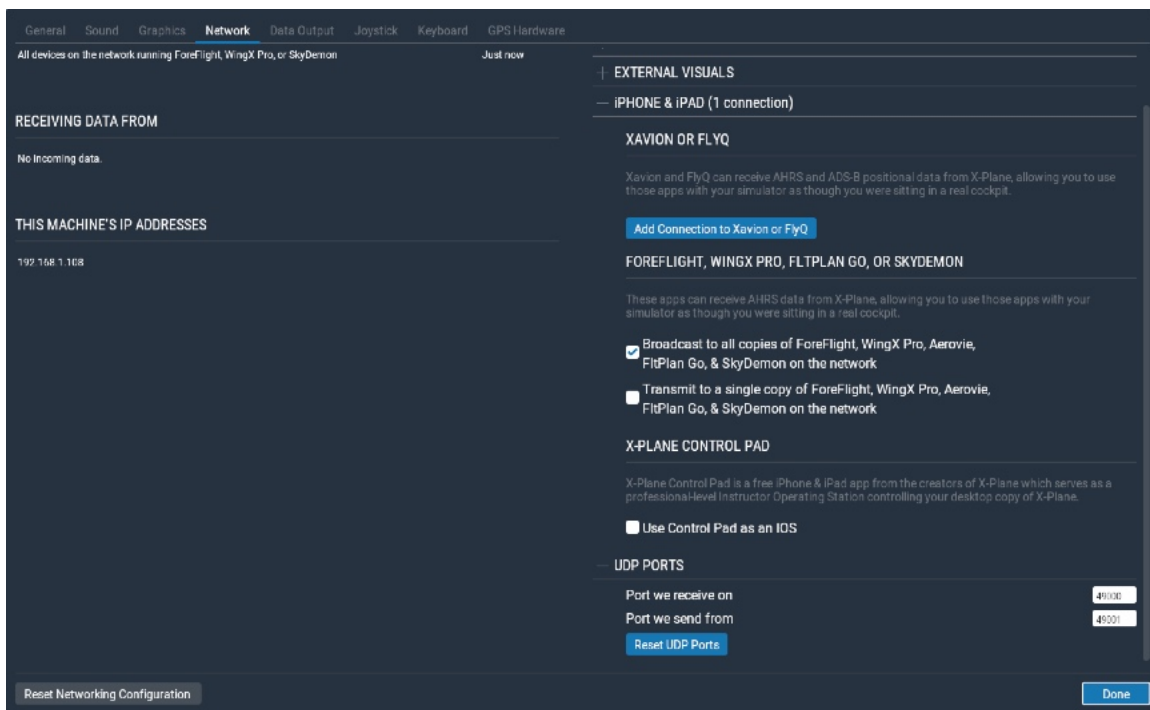

IMPORTANT: DO NOT simultaneously activate an “XAVION OR FLYQ” connection. These connections do not work with ForeFlight Mobile.

Note: if Transmitting to a single device you can identify the IP address in ForeFlight Mobile on More > Devices, by tapping the “i” button. The IP address to enter in X-Plane is NOT the 127.0.0.1 “Loopback” address, but is the Wi-Fi address.

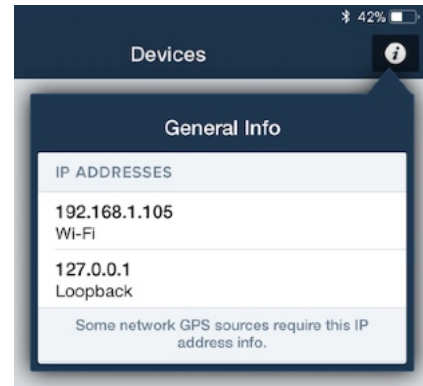

Infinite Flight

Infinite Flight (<http://www.infinite-flight.com>) is a flight simulator available for iOS (iPhone and iPad) and Android (phone and tablet). Infinite Flight version 15.04 or later (either iOS or Android) is able to send simulated position, attitude and traffic data to ForeFlight Mobile running on an iPad or iPhone, provided both devices are connected to the same Wi-Fi network.

Open Infinite Flight, tap the “Gear” button in the upper-left corner , then scroll down to the bottom of the list and tap the “Enable ForeFlight Link” switch ON.

If you are using Infinite Flight Live (additional charge), you can see the other traffic in your area in ForeFlight Mobile by tapping the Maps drop down and enabling the Traffic layer.

If Synthetic Vision is included in your ForeFlight subscription, tap the “AI” button to enable the SV split-screen view showing color coded obstacles and terrain.



Prepar3D/Flight Simulator X

ForeFlight Mobile can receive GPS input from the Prepar3D or Flight Simulator X flight simulators over a Wi-Fi network. Prepar3D v4 includes built-in support for sending simulated position data to ForeFlight Mobile.



In Prepar3D v4, open the Application Options dialog box. Then on the Options menu, click “General” and then click the “Application” tab and Enable “Broadcast GPS data to network”.

Then open ForeFlight Mobile, tap More > Devices > Prepar3D v4 (or the other tile) and slide the Enabled switch ON:

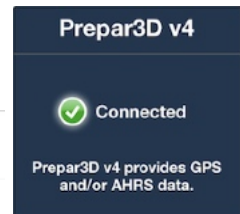

NOTE: Prior versions of Perpar3D and all Flight Simulator X require a plug-in such as MindStar GpsVR, FSXFlight, or FlightsSimGPS. For more information and instructions visit:

- MindStar GpsVR (does not require FSUIPC): http://www.mindstaraviation.com/Product_GPSVR.html
- FSXFlight: www.fsxflight.com
- FlightSimGPS: flightsimgps.com



Pilots who prefer a wired option can use the Cygnus Home Direct. For more information, visit

www.kingschools.com/pilot-supplies/flight-simulator/iPad-connection-wired

Redbird

ForeFlight Mobile can receive GPS input from a Redbird simulator via the Cygnus Pro Wireless connection. For more information visit

www.kingschools.com/pilot-supplies/flight-simulator/iPad-connection-bluetooth

ELITE

ELITE 8.6 (Core, Premium, PCATD, BATD or AATD) can send GPS input to ForeFlight Mobile using the ELITE “Sim to App” iPad Connection Software, available for purchase at www.flyelite.com/shop/sim-to-app-2/

After installing the add-in, follow the included instructions to activate the connectivity with ForeFlight Mobile. NOTE: on the ELITE iPad Configuration screen in the ForeFlight box, press the “SEND” button corresponding either with Broadcast (to all iPads on your network) or to specific devices based on IP address.

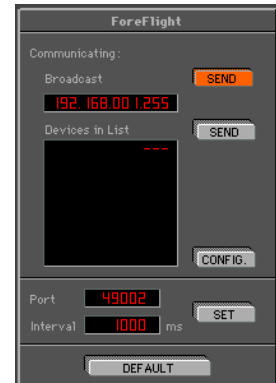

AeroFly FS 2

AeroFly FS 2 for the PC supports sending GPS position data to ForeFlight Mobile. To activate, first identify the IP address of your iPad by tapping **More > Devices**, then tap the “i” in the upper right hand corner of the screen. Record the numbers of the IP address labeled “Wi-Fi”; they will look something like this example: 192.168.1.119

Open AeroFly FS 2 Miscellaneous Settings, enter your iPad IP address into the “Broadcast IP address” box. Make sure the Broadcast IP port is set to: 49002, then click the “Broadcast flight info to IP address” ON.

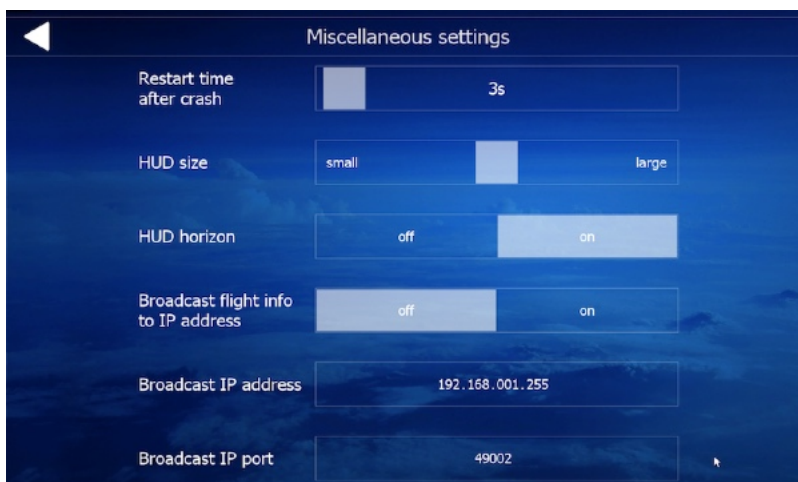

Frasca

Frasca simulators (www.frasca.com) can provide location information to ForeFlight Mobile using the Frasca Upgrade kit, which includes both Wi-Fi and Bluetooth interfaces, as well as the Frasca NorthStar software that provides the simulated GPS position.

The Wi-Fi interface is provided via a wireless router connected to the Frasca FSTD PC, and the Bluetooth interface is provided by a DUAL XGPS160 connected to the FSTD PC by USB cable.

For information about purchase and installation of the upgrade kit in a Frasca simulator, please contact Frasca's Customer Service Department at (217) 344-9200 or support@frasca.com.



Sharing Flights

To share a flight on Twitter or via Email, create a route in Maps. Bring up the Nav Log, if it is not already showing, and tap the **Send To** button. Then tap either "Twitter" or "Email." Note that Twitter will not be an available option until you configure your twitter account in the main iPad Settings app. Twitter is also only available on iOS 5 and higher.

Twitter

Tapping the Twitter option will present a window similar to that shown below. Edit the text as desired and press Send to create the tweet.



Email

Tapping the email option will show a view like that seen below. Provide the email address of the recipient and tap Send. Note that the email will include a link that other ForeFlight Customers can tap to open the route on their own iPad or iPhone.

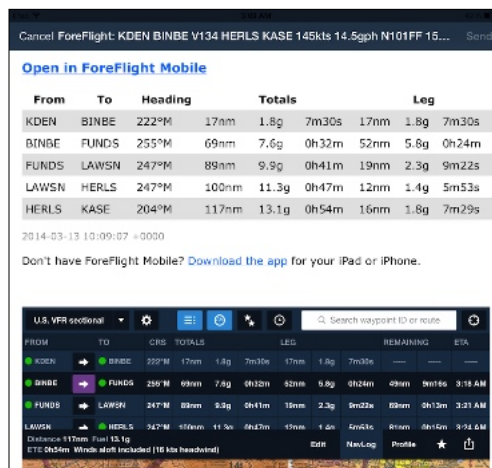

Weather Legends

Radar Legends (when from Internet)

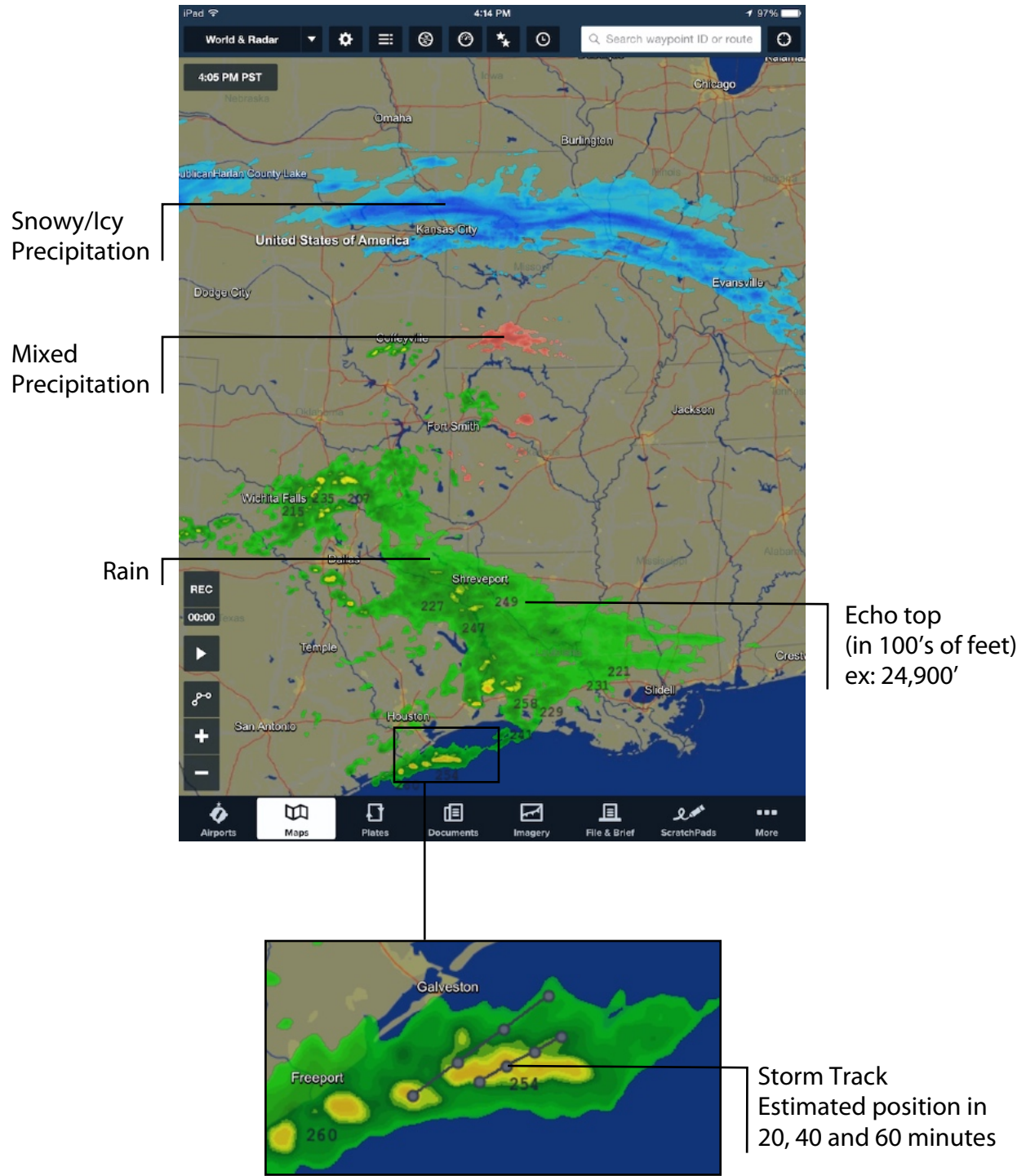

Rain - Radar Intensity (dBZ) vs. Color

Based on RGB values assigned to dBZ range(s)

dBZ	Internet Color ¹	ADS-B Color ^{2,3}	SiriusXM Color ³
5		none shown	none shown
10			
15			
20			
25			
30			
35			
40			
45			
50			
55			
60			
65			
70			
75			
95			

1. Colors are interpolated between levels when rendered on an image.
2. ADS-B (FIS-B) NEXRAD radar is displayed with 6 intensity ranges.
3. Some dBZ intensity/color divisions do not fall exactly on 5 dBZ lines, so are shown as close as possible to specification.

Mixed Rain/Snow - Radar Intensity (dBZ) vs. Color

Based on RGB values assigned to dBZ range(s)

dBZ	Internet Color ¹	ADS-B Color ^{2,3,4}	SiriusXM Color ⁴
5		none shown	none shown
10			
15			
20			
25			
30			
35			
40			
45			
50			
55			
60			
65			
70			
75			

1. Colors are interpolated between levels when rendered on an image.
2. ADS-B (FIS-B) NEXRAD radar is displayed with 6 intensity ranges.
3. FIS-B NEXRAD doesn't include precipitation type, so "Mixed" is displayed at the same reflectivity colors as rain. See AIM Chapter 7: <http://tfmlearning.fly.faa.gov/publications/atpubs/aim/chap7/aim0701.html>
4. Some dBZ intensity/color divisions do not fall exactly on 5 dBZ lines, so are shown as close as possible to specification.

Snow - Radar Intensity (dBZ) vs. Color

Based on RGB values assigned to dBZ range(s)

dBZ	Internet Color ¹	ADS-B Color ^{2,3,4}	SiriusXM Color ⁴
5		none shown	none shown
10			
15			
20			
25			
30			
35			
40			
45			
50			
55			
60			
65			
70			

1. Colors are interpolated between levels when rendered on an image.
2. ADS-B (FIS-B) NEXRAD radar is displayed with 6 intensity ranges.
3. FIS-B NEXRAD doesn't include precipitation type, so "Snow" is displayed at the same reflectivity colors as rain. See AIM Chapter 7: <http://tfmlearning.fly.faa.gov/publications/atpubs/aim/chap7/aim0701.html>
4. Some dBZ intensity/color divisions do not fall exactly on 5 dBZ lines, so are shown as close as possible to specification.

Four-color Radar - Radar Intensity (dBZ) vs. Color

Based on RGB values assigned to dBZ range(s)

dBZ	Internet Color	ADS-B Color	SiriusXM Color ¹
5	none shown	none shown	none shown
10	Green		
15			
20			
25		Green	Green
30	Yellow		
35			
40	Red	Red	Red
45			
50	Magenta	Magenta	Magenta
55			
60			
65			
70			
75			
95			

1. Baron Mobile Link/WXWorx radar does not display in 4-color mode. Only available with SiriusXM when using a GDL 51, GDL 52, or SXAR1.

Baron Mobile Link/WXWorx XM Radar Intensity (dBZ) vs. Color

Based on RGB values assigned to dBZ range(s)



dBZ	Rain	Mixed Rain/Snow	Snow
5	none shown	none shown	none shown
10	Green	Light Purple	Grey
15			
20	Dark Green	Light Purple	Grey
25			
30	Yellow	Light Purple	Grey
35			
40	Orange	Light Purple	Light Grey
45			
50	Red	Light Purple	White
55			
60	Red	Light Pink	Light Blue
65			
70	Purple	Light Purple	Light Blue
75			
95		none shown	none shown

1. Some Baron Mobile Link/WXWorx XM dBZ intensity/color divisions do not fall exactly on 5 dBZ lines, so are shown as close as possible to specification.

Cloud Tops (ADS-B)





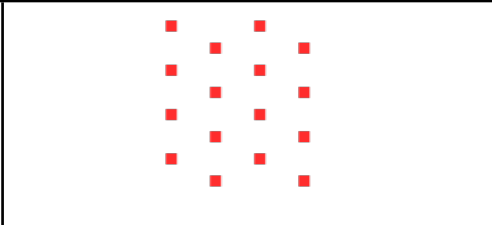



Forecast Cloud Top Height (ft)	Color
Above 24000	Light Blue
Above 21000	Blue
Above 18000	Light Gray
Above 15000	Medium Gray
Above 13500	Dark Gray
Above 12000	Very Dark Gray
Above 10500	Black
Above 9000	Black
Above 7500	Black
Above 6000	Black
Above 4500	Black
Above 3000	Black
Above 1500	Black
Above 0	Black

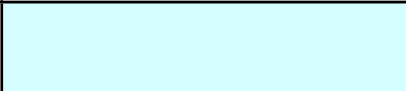



Icing Legend (Internet & XM)

Icing Intensity	Color
Trace, Light	
Moderate	
Heavy, Severe	
SLD Threat (ADS-B & XM only)	

Note: SLD (supercooled large droplets) Threat indicates the potential presence of large droplets of sub-freezing liquid water, which present a more serious icing hazard than standard icing conditions. See [this page](#) for more information on SLD.

Turbulence Legends

Internet Turbulence	
EDR Intensity	Color
10	
20	
30	
40	
50	
60	
70	
80	
90	

XM Turbulence	
Turbulence Intensity	Color
Light	
Moderate	
Severe	
Extreme	

Turbulence intensity is ultimately based on EDR (eddy dissipation rate), a measure of how quickly the atmosphere is releasing energy; however, how this numerical value translates into inflight turbulence intensity depends on a given aircraft's weight.

The internet turbulence layer provides an objective (forecast) measure of EDR which will need to be interpreted in the context of a given aircraft's weight category to arrive at an actual turbulence intensity. The XM turbulence layer assumes a **medium** aircraft weight category and provides actual turbulence intensity for aircraft in that category; smaller aircraft will experience more severe turbulence at a given intensity and larger aircraft will experience less severe turbulence.

The following graphics correlating EDR with turbulence intensity for each weight category can be used as a rough guide:

Light Aircraft (takeoff weight of 15,500 lbs or less)

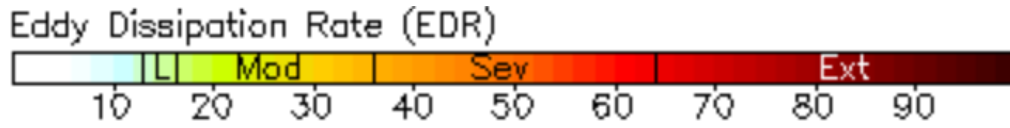



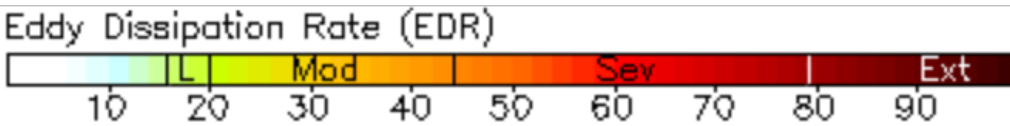



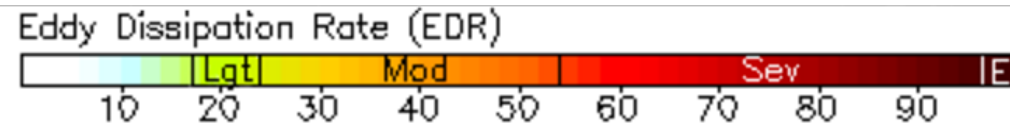



Medium Aircraft (takeoff weight of 15,501 to 299,999 lbs)







Heavy Aircraft (takeoff weight of 300,000 lbs or more)





Surface Analysis Legend (Internet & XM)

Feature	Symbol
Isobars	
Pressure Labels	
High Pressure Centers	
Low Pressure Centers	
Cold Front	
Warm Front	
Occluded Front	
Stationary Front	
Trough	
Squall Line (XM only)	
Dry Line (XM only)	

Radar Legends (when from Internet)

	Lightning (in last 5 minutes)
	Mesocyclone activity (Vortex of rising , rotating air)
	Tornado
	Hail

PIREP Legend

	Icing PIREPs (increasing severity)
	Turbulence PIREPs (increasing severity)
	Sky & Weather PIREP

Tap a PIREP icon to see the “raw” and translated PIREP text:

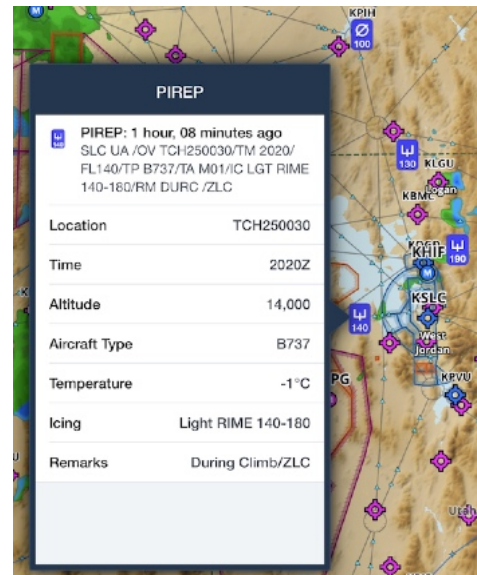

Enhanced Satellite

The Enhanced Satellite layer uses a combination of visible and infrared satellite imagery to provide a global image of cloud formations.

Visible satellite images are primarily used during daytime and are “enhanced” with infrared highlights for the highest cloud tops. During the night, when visible satellite images are not available, the layer relies entirely on infrared images.

Shades of gray are used to represent the lowest-topped clouds; the darker the shade of gray, the lower the cloud tops.

Above the lightest shades of gray you may see blueish colors representing still colder and higher tops. Above this, shades of yellow, orange and red represent the coldest and highest cloud tops.

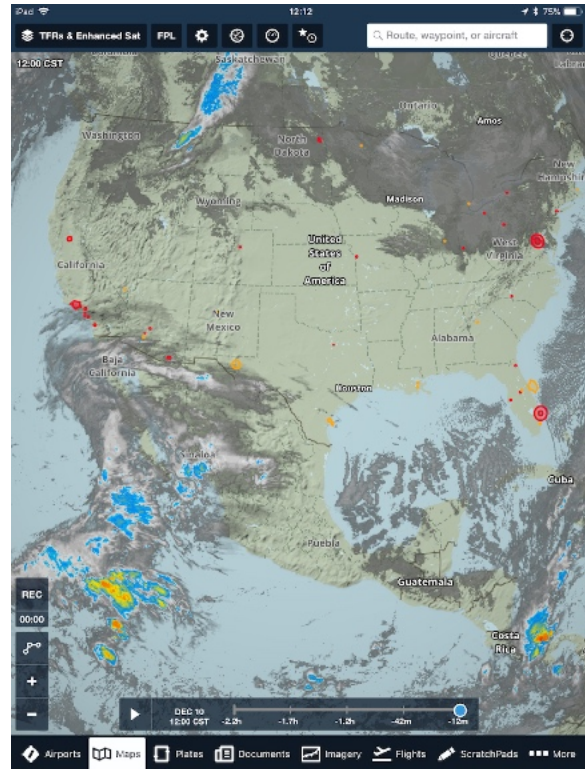











As the temperature of the atmosphere generally decreases with height, a pilot can get a pretty good idea which clouds are high-level and which are low-level based on the color or shades of gray depicted. **Cold cloud tops are often indicative of active thunderstorms that can produce severe or extreme convective turbulence.**

One thing to note is that thick cirrus clouds at very high altitudes will also show up as very cold clouds even though they may not be associated with deep, moist convection. Most of the time these high cirrus clouds do not have the same cellular appearance as convective clouds and thus have very little variation in color.

See the temperatures that correspond to different colors in the table on the next page.

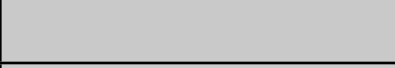
Based on RGB values assigned to temperature range(s)

Temperature °C	Color	Relative Cloud Top Height	
-83		Higher	
-75			
-70			
-65			
-63			
-54			
-50.2			
-50			
-38			
-28			
+12			Lower

Color IR Satellite

Unlike the Enhanced Satellite layer, the Color IR Satellite layer relies solely on infrared satellite imagery to display global cloud coverage, and uses a more refined color scale to represent cloud top temperature.

The IR Satellite layer is a close cousin of the [static color IR satellite images](#) found in the Imagery view. The static images show not only the temperature of the cloud tops using the same colors, but also the temperature of the surface of the earth. This can make it difficult to know where clouds exist and where the sky is clear.

The main improvement of the Color IR Satellite layer over the static images is that it attempts to mask out regions where the sky is clear, showing the map background in those regions instead of the surface temperature.

While this masking algorithm works a majority of the time, it can be difficult to get it right every single time simply using temperature alone. For example, anytime there's a shallow low-topped stratus deck, the tops of the clouds may actually be slightly warmer than the surface of the earth courtesy of a surface-based temperature inversion. So the algorithm may have a difficult time discerning where it is cloudy or clear. It's important to always enable the Sky Coverage layer to pick up on these issues when they occur.

You can learn more about the Color IR Satellite layer and how it can be used to gauge cloud height by reading [this blog post](#) by weather scientist Scott Dennstaedt.

See the temperatures that correspond to different colors in the table on the next page.

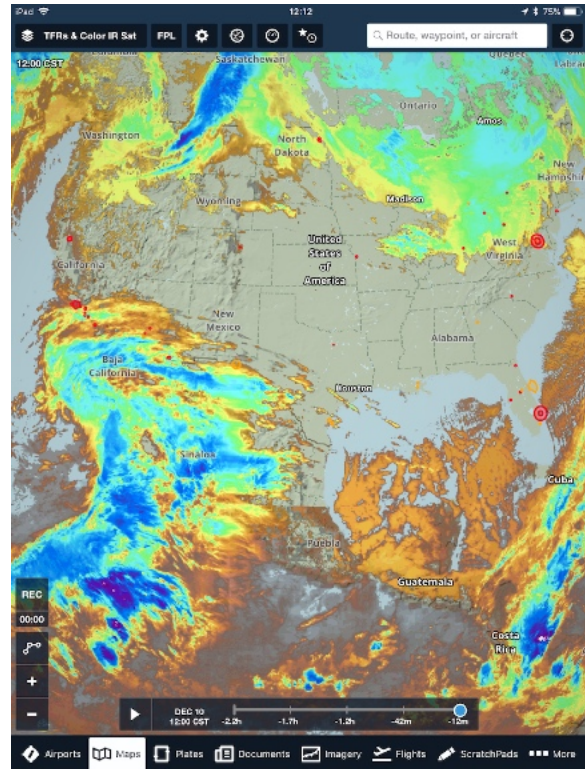

Based on RGB values assigned to temperature range(s)

Temperature °C	Color	Relative Cloud Top Height
-72		Higher
-68		
-64		
-60		
-56		
-52		
-48		
-44		
-40		
-36		
-32		
-28		
-24		
-20		
-16		
-12		
-8		
-4		
0		
4		
8		
12		
16		
20		
24		
28		
32		
47	<i>Transparent</i>	Lower

Learning More

To learn even more about ForeFlight Mobile, please visit our website for frequently asked questions (FAQs) and video tutorials.

FAQs: www.foreflight.com/support

Videos: www.foreflight.com/videos

“ForeFlight 101 - Beginner Tutorial” and “ForeFlight 201 - Advanced Course” video presentations: www.foreflight.com/support/training/

To help us at ForeFlight learn more about how you fly, please send any and all feedback on our applications to team@foreflight.com - we read and respond to each note we receive. We also get a kick out of hearing your flying stories, so please do share!

Pilot's Guide Change History

For v12.0 NOTE: REQUIRES iOS 11.0 or LATER

- ❖ With Performance plans the [3D Review](#) of planned flights and recorded [Track Logs](#) now offers first- and third-person camera modes as well as a translucent blue “curtain” route line. In third-person mode you can pan, tilt, and zoom the view to see it from any angle.
- ❖ ForeFlight Mobile can now import and display [Garmin G1000 track logs](#) recorded onto an SD card by a suitably configured Garmin G1000, to simplify how you organize and access your recorded flights.
- ❖ Tap a [PIREP](#) icon on the Maps page to see “raw” and translated text.
- ❖ For pilots with a Performance plan who prefer a [Navlog](#) design with more space on each row, choose the new International Navlog Template by viewing a Navlog and tapping the “Gear” button. The International Navlog template includes extra space for notes, ATIS, inflight actuals, and remarks.
- ❖ Tap on a [Distance Rings](#) label to change the style (eg: from Distance to Time); the style can also be selected in More > Settings.
- ❖ Added Biplane and Floatplane Location Markers, which can be selected in More > Settings > Current Location Marker.

For v11.11 NOTE: REQUIRES iOS 11.0 or LATER

- ❖ [Enhanced Approach Procedure Markers](#) are speed, altitude, and IAF/FAF information for each waypoint marker in the procedure, which show on the Map even when the procedure plate isn't displayed. The marker label shows associated altitude and/or speed limits in addition to the waypoint name, and the initial and final approach fixes are depicted with unique icons. The markers are available in Performance Plus and Business Performance plans.
- ❖ Files, documents, and photos, can now be attached to an individual [Flight](#) for improved organization and easy access while airborne.
- ❖ When viewing the Maps view Route Editor, airport or runway closure NOTAMs are now indicated via a [red warning icon](#) on the airport's route bubble. Tap the bubble to navigate to a pop-up showing the NOTAM.

- ❖ With a Pro Plus or Performance plan, when Jeppesen coverage has also been purchased through ForeFlight (or a Jeppesen account has been linked to the ForeFlight account) any Jeppesen SIDs/STARs that have been georeferenced will automatically be shown on the map in the [Procedure Advisor](#). Georeferenced SIDs/STARs can also be sent to the Maps page.
- ❖ Pilots filing [VFR flight plans in Canada](#) can now access new fields in the filing form to better comply with NAV CANADA requirements for VFR flights.
- ❖ The [Weather Imagery](#) catalog has been updated to reflect changes by NOAA.

For v11.10 NOTE: REQUIRES iOS 11.0 or LATER

- ❖ While connected to the Internet, the limits of [Radar Coverage](#) can now be highlighted with a “Radar not available” message and grey /// marks across the screen (similar to when viewing Radar via ADS-B or XM). The display updates dynamically to reflect radar provider outages, and can be selected ON or OFF in [Maps Settings](#).
- ❖ For devices running iOS 13 and above, the “Auto” [Light/Dark mode](#) has been replaced by the iOS System Theme setting. If you set a sunrise-to-sunset or custom schedule for automatic theme changes in your device’s Settings app, ForeFlight’s theme will follow the same schedule when the System option is selected.
- ❖ ForeFlight [Logbook](#) now allows you to add or remove a recorded [Track Logs](#) associated with a Logbook entry, to more accurately log your flights. Only 1 Track Log can be associated with a particular Logbook entry.
- ❖ ForeFlight now supports connectivity with the [DAC International GDC64](#) Tablet Aircraft Interface Unit, providing a wired option to supply ForeFlight with GPS and ADS-B data, as well as a constant power supply.

For v11.9 NOTE: REQUIRES iOS 11.0 or LATER

- ❖ The new [High Resolution Basemap](#) depicts ground features and cultural elements in much greater detail for improved inflight reference. This includes higher-resolution roads and railroads, more detailed coastlines, and new terrain peak markers with associated altitudes.

- ❖ [FBO entries](#) now include fees sourced from AOPA's Airport Directory to help you make more informed flight planning decisions. View known fees in the new Fees tab of the FBO detail view. ForeFlight lists the type of fee, the cost, any notes, and provides a detailed breakdown for fees that vary by aircraft type or other factors.
- ❖ The Maps drop-down now allows you to [toggle multiple map layers](#) in a row without having to reopen the Layer Selector each time, by enabling the new "Multiple Selections" setting at the bottom of the Map Settings menu. Once enabled, the Layer Selector remains open until you tap elsewhere on the screen, allowing you to quickly toggle as many layers as you want. And on the Pad, you can also now pan and zoom around the map while the layer selector is open, even if the Multiple Selections setting is disabled.
- ❖ ForeFlight can now automatically fill certain [Logbook](#) fields based on a flight's Total Time, simplifying the process of filling in new entries. The other new Logbook setting, "Total time Calculation" allows you to choose how ForeFlight calculates Total Time if you don't enter it directly. Options include Hobbs Time, Tach Time, Block Time, Flight Time, or Duty Time.
- ❖ The [Takeoff & Landing Performance](#) calculations can now add built-in safety margins for based on runway conditions or other factors. The new Safety Distance Factor field at the bottom of the Takeoff or Landing pages on Flights specifies the amount of safety margin (a decimal number between 1.0-10.0x) for each calculation. ForeFlight saves and automatically applies your takeoff and landing distance factor on future flights with the same aircraft. Requires Performance Plus subscription.
- ❖ If you use Rockwell Collins/ARINC as your data-link service provider, you can now generate FMS flight plan uplink/recall codes directly from ForeFlight. After filing a flight plan, open the Flights view Navlog to find the auto-generated recall number in the bottom-left. ForeFlight also supports FMS flight plan uplink with Satcom Direct and Honeywell avionics. FMS flight plan uplink requires a Performance Plus or Business Performance subscription.

For v11.8 NOTE: REQUIRES iOS 11.0 or LATER

- ❖ The top of the [Track Log](#) list now has a Search box where you can search Track Logs by departure or destination, aircraft, GPS source, and device name.

- ❖ When viewing an Airport, [tap an FBO to see any Fuel Price](#) notes below the fuel prices. The fuel prices notes are added and maintained by the FBO manager.

For v11.7 NOTE: REQUIRES iOS 11.0 or LATER

- ❖ US subscribers can now download and view [VFR Flyway charts](#) directly on the Maps page. These planning charts depict potential VFR routes through and around major metropolitan areas to help VFR pilots avoid Class B airspace and commercial traffic flows. They appear as a new option at the bottom of the left-hand column in the layer selector, and as a configurable download switch in More > Downloads > Download Settings > United States.
- ❖ The Maps page now features [improved Map Layer and single-tap functionality](#). You can simultaneously enable multiple shape-based map layers like TFRs and AIR/SIGMET/CWAs, then tap where they overlap to select which one you want to view information about. Tapping on an area where multiple information types are displayed now shows a multi-layer “Map Info” pop-up, allow you to select the element you want to see. And you can also now tap on FBO markers that are built into the Aeronautical Map airport diagrams to quickly access information about them.
- ❖ Read-only copies of Aircraft can now be [shared between accounts](#). Shared aircraft are only visible in ForeFlight Mobile 11.7 and later. If an Aircraft is shared from a Performance Plus account to a Basic Plus or Performance Plus account, the ForeFlight Performance profile will not be available in the recipient account.
- ❖ The FAA/Domestic Flight Plan form was discontinued by the FAA effective August 27, 2019. Therefore the ICAO flight plan form must be used when filing all VFR & IFR flight plans.
- ❖ Added support for new document types on the [Documents](#) view: CSV, Apple Pages, Keynote, and Numbers files can now be imported via AirDrop, email, iTunes, or with a Pro Plus subscription or above, via a connected cloud storage account.
- ❖ In [Documents](#), personal drives such as Imported and/or connected Cloud drives are now listed separately for easier access.
- ❖ [Logbook](#) now Auto-Calculates Night Times from draft Logbook entries created from filed flight plans or a recorded Track log. ForeFlight automatically calculates how much of each flight may be logged as Night Time.

- ❖ [European Graphical NOTAMs](#) are now displayed for most of Europe and Turkey. NOTAMs are color-coded based on type and severity, with airspace and obstacle notices in gray, scheduled exercises in orange, and restricted/danger areas in red. Graphical NOTAMs are downloaded when you [Pack](#) for a flight, so you can access them in-flight without an internet connection.
- ❖ Customers in Europe with [FLARM receivers that provide traffic data via the NMEA protocol](#) can now display that traffic in ForeFlight Mobile via a compatible adapter (typically Wi-Fi).
- ❖ Expansion of the European AIP coverage continues with the addition of AIPs for Bulgaria, Cyprus, Turkey, Albania, Serbia and Montenegro, Bosnia and Herzegovina, Moldova, Romania, and North Macedonia. These include IFR High and Low enroute charts for all countries other than Turkey, VFR procedure charts for all countries other than North Macedonia, IFR procedure charts, and documents.

For v11.6 NOTE: REQUIRES iOS 11.0 or LATER

- ❖ You can now review the route of a planned flight before departure or a completed flight recorded with a Track Log using [3D Review](#). 3D Review combines high-resolution terrain and aerial imagery in an interactive 1x-20x speed replay. Requires Performance Plus or Business Performance.
- ❖ [Map Annotations](#) allow you to draw directly on the Maps page using your finger or an Apple Pencil. Annotations scale as you zoom and can be displayed over any Map.
- ❖ Logbook automatically calculates Night Time and Night Landings and populates these values in your Logbook entry.
- ❖ Logbook Instructor Tools is a convenient place for flight instructors to manage their certificate information, and issue remote endorsements to students. Instructors can easily keep track of past endorsements, and issue new ones, in the Endorsement Records view.
- ❖ Clarified the process for [Amending a Flight](#) plan: on your filed Flight you should update the route, ETD, or whatever changes are needed, THEN tap the “Amend” button.
- ❖ Complete your [Checklists](#) more efficiently by using the [“Speak” option](#) to hear each entry read in order. When a Checklist is being spoken, the control panel remains in view on any page in the app.

- ❖ The Pack feature on the Flights view now includes airport, weather, and chart information between your destination and your selected Alternate.
- ❖ In Europe, [a new graphical GAFOR](#) (General Aviation Forecasts) Map layer is available covering France, Germany, Switzerland, Austria, Slovenia, and Croatia. GAFOR data is included when you Pack for a flight, so you can access the GAFOR Map layer without an internet connection.
- ❖ Expansion of the European AIP coverage continues with the addition of AIPs for Estonia, Latvia, Lithuania, Belarus, and Ukraine. These include IFR High and Low enroute charts, IFR procedure charts, and documents for all five countries, as well as VFR procedure charts for all countries except Ukraine, and integrated Jeppesen VFR data for Estonia, Latvia, and Lithuania.

For v11.5 NOTE: REQUIRES iOS 11.0 or LATER

- ❖ The new [Graphical Track Log view](#) provides detailed metrics for a better post-flight debrief. The new Track Log Graph shows changes in a flight's altitude and speed based on GPS data, as well as pitch and bank if the Track Log was recorded while connected to an AHRS-capable device like Sentry.
- ❖ [Alternate Advisor](#) lets you quickly find suitable alternate airports near your destination. Alternate Advisor shows an overview map along with a list of suggested alternate airports near your destination. The list includes weather, runway, and types of approaches, as well as time and fuel required to reach each alternate from your primary destination.
- ❖ You can now select a runway for departure and landing by tapping the departure or destination airport bubble in the Maps > NavLog. When selected, the destination runway is highlighted on the map with a blue line and chevrons, and the departure runway is identified by white chevrons extending out from the centerline.
- ❖ For airports in the US, the Clearance category on the [Airport Frequencies](#) tab now includes the phone number to call to obtain an IFR clearance.
- ❖ [Organized Track System \(OTS\)](#) can now be filtered to show only Easterly or Westerly Oceanic tracks. Requires Performance Plus or Business Performance subscription.

- ❖ For pilots flying in Europe with a [uAvionix SkyEcho 2](#) portable GPS & ADS-B receiver, ForeFlight Mobile can now decode and display FLARM traffic data. FLARM traffic appears on the map just like ADS-B traffic, with basic information about each traffic target. An app-specific decoding License is required to display FLARM traffic from a SkyEcho 2 in ForeFlight Mobile, and the license can be purchased at ForeFlight's website.
- ❖ Expansion of the European AIP coverage continues with the addition of AIPs for the Czech Republic, Slovakia, Hungary, Poland, and Greenland. This includes IFR procedure charts and airport diagrams for all countries; VFR procedure charts for the Czech Republic, Hungary, and Poland; IFR High and Low enroute charts for the Czech Republic, Hungary, Poland, and Slovakia; and documents for all countries.

For v11.4 NOTE: REQUIRES iOS 11.0 or LATER

- ❖ For Performance Plus and Business Performance subscribers, the Flights view now features integrated [Takeoff & Landing Performance](#) calculations. They incorporate aircraft performance and weather data (live, or pilot-entered) to calculate important flight metrics such as Takeoff Roll, Approach speed, etc..., and help pilots ensure they're within the aircraft's and runway's limits. Available for over 160 popular piston and single-engine turboprop aircraft, with more planned in the future. For full details, see the **Performance Planning in ForeFlight Mobile** guide in Documents.
- ❖ [Flight Sharing](#) allows you to share a read-only copy of planned and filed flight plans with others via Airdrop, email, or text directly from the Flights view, enabling better coordination with fellow pilots and crew. Any changes you make to the flight will be synchronized to the share recipients.
- ❖ The [Logbook](#) now automatically suggests adding any photos or screenshots taken during the time of your flight to a Logbook entry. Suggested photos are **NOT** synchronized to your account unless you specifically select to add the photo to the .
- ❖ In [Logbook](#) you can now track night vision goggle (NVG) currency for both rotorcraft and airplane pilots, with separate currency trackers for NVG operations with and without passengers.
- ❖ The [Flights Navlog](#) features several improvements, including listing the Altitude next to the selected cruise profile in the upper left header and after the route in the summary section, added "MAG" next to HDG and CRS in the waypoint list to clarify that those values are magnetic,

and displaying airport diagrams (when available) for departure and destination airports.

- ❖ When using [Procedure Advisor](#) to add a SID/STAR with an leg that can't be depicted (eg: Radar Vectors...) ForeFlight Mobile now shows a [dotted-line](#) for that segment of the route.
- ❖ Expansion of the European AIP coverage continues with the addition of Spain & Portugal, including IFR and VFR procedure charts, airport diagrams, and documents. The DFS VFR 500 Chart covering both Spain and Portugal is also available as an optional add-on to enhance your visual flying.

For v11.3 NOTE: REQUIRES iOS 11.0 or LATER

- ❖ The [Documents](#) page features some big changes in this release. ForeFlight Mobile 11.3 introduces a new folder- and drive-centric layout to the Document page, adds the concept of "Subscriptions" that allow the app to automatically be kept up to date as new documents are added to a drive, adds syncing of documents and annotations between devices, and last but not least, adds the Documents view to the iPhone.
- ❖ Unified App Search has been expanded to include [searching for Document titles](#) from the search on the Documents tabs, as well as the Airports, Maps, and Plates tabs.
- ❖ Import your custom procedures and airport diagrams as geospatial PDF files using Content Packs, BYOP folders, or as standalone files. Geospatial PDFs behave just like georeferenced charts available through ForeFlight, allowing you to view them in the Airports and Plates views, display them on the map, and see your position on them.
- ❖ The [Proceed to File](#) button now displays a filing form modal box where you can edit and file your flight plan, and the filing confirmation and briefing emails sent after a plan is filed are now combined into a single email.
- ❖ Expansion of the European AIP coverage continues with the addition of Greece and Malta IFR and VFR procedure charts, airport diagrams, documents, and IFR high and low enroute charts for Malta. Jeppesen's IFR and VFR aeronautical data is also included for both countries.

For v11.2 NOTE: REQUIRES iOS 11.0 or LATER

- ❖ Introducing the free companion app [ForeFlight Passenger](#) that lets your passengers follow along with the flight on their own iOS devices,

including continually updated route and ETA. Multiple passengers can run Passenger at one time and all receive updates from a pilot's copy of ForeFlight Mobile.

- ❖ When planning a route on the Maps page, the [Profile view](#) now shows the Route Line including climb and descent profiles, and Top of Climb (TOC) and Top of Descent (TOD) points. Requires Pro Plus or higher subscription.
- ❖ When viewing the Aeronautical Map with airspace displayed, you can [Hide Airspace above a specified altitude](#) to declutter the view of airspace that's not relevant to your flight. Airspace on your route automatically displays if you fly within 1,000' of it vertically.
- ❖ [3D View is now available anywhere](#), not just at airports. Touch-hold on the map, then tap the 3D button in the upper-right of the pop-up to view the 3D view that combines high-resolution terrain and aerial imagery at that location. Requires an active Internet connection, and Performance Plus or Business Performance subscription.
- ❖ When sending a Flight or Track Log on which Block times have been entered in the Flight Log to Logbook, the Block times are carried-over and appear in the new Logbook entry.
- ❖ The [Flights](#) view Search bar supports filtering the view by Aircraft, Departure, and Destination.
- ❖ The Gogo ATG and AVANCE line of inflight Wi-Fi systems can now provide GPS position and indicated altitude. Expensive data usage by ForeFlight Mobile over Gogo's network can also be limited. (Gogo support requires Performance Plus or Business Performance subscription).
- ❖ Europe AIP coverage added for Italy, Croatia, and Slovenia, which include airport diagrams, IFR and VFR procedure charts, IFR ICAO charts for Italy, and documents. New optional VFR add-ons are also available, including Italy Avioportolano VFR Flight Guide and VFR chart, Italy DFS VFR 500 Chart, Croatia DFS VFR 500 Chart, Slovenia Rogers Data VFR Trip Kit and 1:200K Chart, and Air Million 1:1,000,000 Chart combo which covers Western, Central, Southern, and some of Eastern Europe, as well as the Azores, Madeira, and Canary Islands.

For v11.1 NOTE: REQUIRES iOS 11.0 or LATER

- ❖ When you enter a route if it is too short to climb to the selected aircraft's default cruise altitude, the app will [display a popup](#) suggesting a lower cruise altitude.

- ❖ When you file a plan, the Flights view now shows the [Filed and Expected Routes](#) (if an Expected Route is received), along with the currently planned route (if different).
- ❖ When preparing to [file a flight plan](#) (after tapping “Proceed to File” from a Flight) Airspeed can now be selected in Mach or Kilometers per Hour.
- ❖ A waypoint can now be removed from the route by tapping it on the Maps view, then tapping “[Remove from Route](#)” at the top of the popup.
- ❖ When viewing an [FBO’s details](#) on the Maps or Airports page, three new buttons near the top of the window allow you to call the FBO, Locate the FBO on Apple Maps (and get directions), or email the FBO.
- ❖ Draft Logbook entries can now be automatically created when you file a flight plan. This setting is controlled in More > Logbook > Settings > Draft Entry Creation. Draft entries created from a filed flight plan include: the departure and destination airports, filed route, date and time, aircraft, total time based on expected ETE, and one takeoff and one full-stop landing.
- ❖ Europe AIP coverage added for the U.K., Ireland, and Norway, which include airport diagrams, IFR and VFR procedure charts, IFR enroute charts for Norway, and documents. New optional VFR add-ons are also available, including United Kingdom NATS VFR ICAO Chart (1:500k), United Kingdom Pooleys VFR Trip Kit, Ireland Pooleys VFR Trip Kit, and Norway Avinor VFR ICAO Chart

For v11.0 NOTE: REQUIRES iOS 11.0 or LATER

- ❖ The new [Airport 3D View](#) combines high-resolution terrain and aerial imagery to give you a flexible preview of the airport area, with pan, zoom, and buttons to select a desired runway to view. Airport 3D View is included in Performance Plus, Business Performance, and MFB Performance subscription plans.
- ❖ You can now view the track you’ve recently flown on the Maps page by enabling the [Breadcrumbs](#) feature, an extension of the ForeFlight [Track Log](#) capability. Enabling or disabling Breadcrumbs does not affect Track Log recording.
- ❖ When connected to an ADS-B receiver, the FAA’s new [Graphical AIRMETS](#) are now available like regular AIRMETS. G-AIRMETS can be filtered by hazard type, and also include a new time slider so you can filter G-AIRMETS based on their effective times. The freezing levels G-

AIRMET, appears as its own layer, using colored lines to indicate where freezing occurs at different altitudes for the contiguous U.S.

- ❖ Search Logbook entries based on comments, flight tags, or aircraft equipment type, and view a person's details in Logbook > People to see all entries in which that person was logged.
- ❖ ForeFlight Mobile can now import and display KMZ files, either standalone or included in content packs. KMZ files can contain multiple KML files as well as custom icons.
- ❖ On the More > [Settings](#) page, you can now use the Filter box at the top of the page to filter settings by name or section title to more quickly locate a specific setting or section.
- ❖ Europe AIP coverage added for Netherlands, Denmark, and Faroe Islands, with available optional VFR add-ons: Netherlands and Denmark DFS Visual 500 Charts.

For v10.6 NOTE: REQUIRES iOS 10.3 or LATER; some features require iOS 11 or LATER

- ❖ User Content (including Custom Charts, Custom Map Layers, and User Waypoints) is now called [Custom Content](#).
- ❖ Introducing [Content Packs](#): pilot-created bundles of maps, map layers, waypoints, and procedures that are distributed together in a single file to enhance planning and flying. Content Packs are available with Basic Plus, Pro Plus, Performance Plus, Business Performance, and MFB Performance subscriptions.
- ❖ The Logbook Experience Reports now also offer a summary of your logged simulator time with two new sections for simulated aircraft and flights, including simulated instrument and dual given/received.
- ❖ Europe AIP coverage added for Sweden and Finland with available optional VFR add-ons: LFV and ANS VFR ICAO charts.

For v10.5 NOTE: REQUIRES iOS 10.3 or LATER; some features require iOS 11 or LATER

- ❖ [Synthetic Vision is now available on iPhone](#), including detailed 3D terrain, obstacles, and runways in full screen Portrait or Landscape mode, along with "Glance" mode. Available on all iPhones that run current versions of ForeFlight Mobile *except* for iPhone 5, 5S, and SE.

- ❖ Logbook entries now include an interactive overview map for reference when reviewing past entries. The actual route is shown when there is an associated Track Log for the flight; if no Track Log is available the planned route is shown.
- ❖ ForeFlight on the web now includes [Digital ATIS \(D-ATIS\)](#) (requires Performance Plus or Business Performance subscription) at any of the 76 major U.S. airports that currently support D-ATIS.
- ❖ Share your [Flight's detailed Navlog and ICAO Flight Plan](#) form as a single, combined PDF using the Send To menu in the top right of the Filing page, after tapping "Proceed to File" for a Flight.
- ❖ Step Climb indicators are now shown in Route Advisor, Altitude Advisor, and the flight plan filing form when a step climb is required to reach a flight's planned final cruise altitude. To see where in the flight the step takes place, look in the Navlog's altitude column (requires Performance Plus or Business Performance subscription)
- ❖ Europe AIP coverage now includes Austria, Belgium, Luxembourg, and Iceland, as well as optional VFR add-ons: Rogers VFR Guide and VFR ICAO charts (Austria), DFS Visual 500 charts (Austria, Belgium, and Luxembourg), CartaBossy VFR charts (Belgium and Luxembourg), and Jeppesen's VFR procedure charts (Austria, Belgium, and Luxembourg).
- ❖ Support added for Satcom Direct SDR Gateway, featuring GPS, AHRS, and Pressure Altitude (requires Performance Plus or Business Performance subscription).