



ForeFlight WEIGHT & BALANCE Guide



ForeFlight
A Boeing Company

Copyright © 2023 ForeFlight LLC. All rights reserved.

The unauthorized commercial distribution of this manual or any revisions is strictly prohibited.

ForeFlight® is a registered trademark of ForeFlight, a Boeing Company, and may not be used without the explicit written consent of ForeFlight.

CONTENTS

- DEFINITIONS6**
- INTRODUCTION7**
 - 1.1 Types of Weight & Balance Tools8**
 - 1.1.1 Legacy Weight & Balance8
 - 1.1.2 Enhanced Weight & Balance8
 - 1.1.3 Integrated Weight & Balance8
 - 1.2 Enhanced Weight & Balance Differences9**
 - 1.3 Converting from Legacy to Enhanced10**
- WEIGHT & BALANCE PROFILES11**
 - 2.1 Weight & Balance Profile Required Information.....12**
 - 2.2 Creating an Aircraft Profile.....13**
 - 2.2.1 Aircraft Profile Weights Section.....14
 - 2.3 Adding a Weight & Balance Profile.....15**
 - 2.3.1 Adding Profiles with the Aircraft View.....15
 - 2.3.2 Adding Profiles with the Weight & Balance View15
 - 2.3.3 Adding Profiles with the Flights View16
 - 2.4 Types of Templates17**
 - 2.4.1 Prebuilt Templates.....18
 - 2.4.2 Blank Templates.....19
 - 2.4.3 Legacy Templates20
 - 2.5 Weight & Balance Template Design.....21**
 - 2.5.1 General Section22
 - 2.5.2 Stations Section23
 - 2.5.3 CG Limits Section24
 - 2.5.4 Default Curtailment Options27
 - 2.5.5 Envelope Preview28
 - 2.5.6 Use %MAC28
 - 2.5.7 Gear Retraction Moment Change29
 - 2.6 Types of Weight & Balance Stations30**
 - 2.6.1 Single Seat.....30
 - 2.6.2 Row of Seats.....31
 - 2.6.3 Cargo32
 - 2.6.4 Aircraft Items32
 - 2.6.5 Fuel Tanks.....32
 - 2.6.6 Include in BOW34
 - 2.6.7 Station Notes35

CONTENTS

MIGRATION ASSISTANT	36
3.1 Migration Assistant Discrepancies.....	38
COMPLETED W&B PROFILES	39
4.1 Aircraft with Multiple Weight & Balance Profiles	40
4.2 Copying, Editing, and Deleting Profiles	40
4.2.1 Copying, Editing, and Deleting with the Aircraft View	40
4.2.2 Copying, Editing, and Deleting with the W&B View	40
4.2.3 Copying, Editing, and Deleting with the Flights View	41
4.3 Sharing Weight & Balance Profiles.....	42
4.3.1 Sharing Profiles with the Aircraft View	42
4.3.2 Sharing Profiles with the Weight & Balance View	42
4.3.3 Sharing Profiles with the Flights View	43
4.4 Importing a Shared Profile	44
4.5 Weight & Balance Profile Missing Details.....	45
CALCULATING WEIGHT & BALANCE.....	46
5.1 Calculating Weight & Balance.....	46
5.1.1 Curtailment Options	47
5.1.2 Enabling Standard Weight Curtailment.....	48
5.1.2 Special Considerations for Seats.....	53
5.2 Weight & Balance Results	55
5.3 Warnings	56
5.4 Weight & Balance Load Summary	57
5.4.1 Signing the Load Summary.....	58
5.5 Integrated Weight & Balance.....	60
5.5.1 Integrated Weight & Balance Results	62
5.5.2 Removing Integrated Weight & Balance	62
5.6 Ballast Fuel	63
5.6.1 Adding Ballast Fuel	63
LEGACY WEIGHT & BALANCE.....	64
6.1 Creating Profiles.....	66
6.1.1 SmartOptions Interview.....	66
6.1.2 Manual Interview	67
6.1.3 Completing a Manual Profile	68
6.2 Complete Profiles	76
6.3 Calculating Weight & Balance.....	77
6.3.1 Saved Loads	78

CONTENTS

- 6.4 Copying a Profile79**
- 6.5 Sharing a Profile79**
- 6.6 Deleting a Profile80**
- CHANGE HISTORY81**

DEFINITIONS

Abbreviation	Definition
BEW	Basic Empty Weight
BOW	Basic Operating Weight
CG	Center of Gravity
FAA	Federal Aviation Administration
ICAO	International Civil Aviation Organization
KG	Kilogram
LBS	Pounds
LDW	Landing Weight
MAC	Mean Aerodynamic Chord
MLDW	Maximum Landing Weight
MRW	Maximum Ramp Weight
MTOW	Maximum Takeoff Weight
MZFW	Maximum Zero Fuel Weight
PDF	Portable Document Format
STC	Supplemental Type Certificate
TOW	Takeoff Weight
W&B	Weight & Balance
ZFW	Zero Fuel Weight

INTRODUCTION

ForeFlight Weight & Balance (W&B) allows pilots to calculate an aircraft's W&B in real-time. By providing timely information, ForeFlight Mobile helps pilots ensure their aircraft is operating safely and within its limitations.

This guide is intended to provide a comprehensive overview of the Weight & Balance tool in ForeFlight Mobile, including how to use it, its features, and how it can benefit pilots during flight planning. For a video demonstration, see the [ForeFlight Weight & Balance webpage](#).

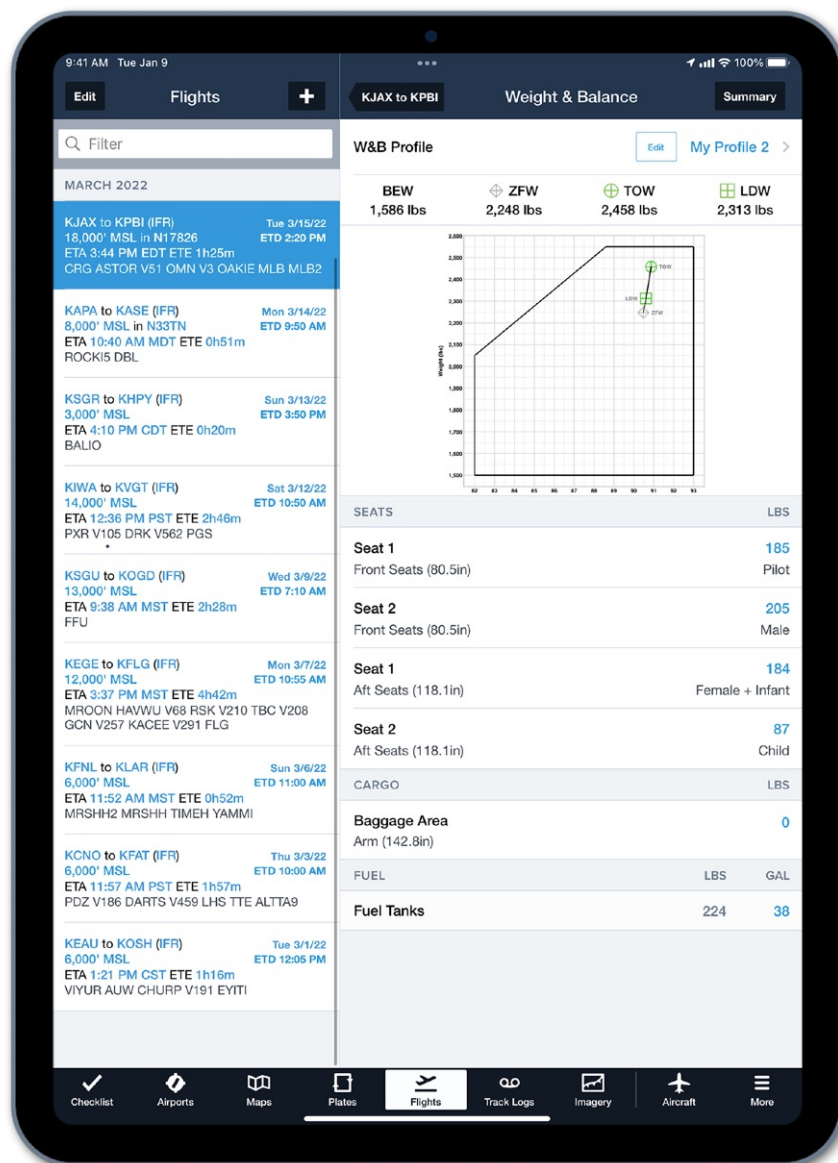

ForeFlight Mobile Integrated Weight & Balance

1. INTRODUCTION

1.1 Types of Weight & Balance Tools

ForeFlight Mobile offers three distinct Weight & Balance tools. Each type is described below.

1.1.1 Legacy Weight & Balance

Legacy Weight & Balance is the original, standalone ForeFlight Weight & Balance tool. Legacy W&B is not integrated with any other ForeFlight Mobile features.

Legacy W&B is still available to Basic Plus, Pro Plus, and Performance Plus customers by disabling Enhanced Weight & Balance in **More > Accounts > ForeFlight Labs**. Business and MFB customers can request access to Legacy Weight & Balance by contacting team@foreflight.com. Legacy W&B is being replaced by Enhanced W&B. Pilots should upgrade to Enhanced W&B at their earliest convenience.

IMPORTANT: Pilots must choose either **Legacy Weight & Balance** or Enhanced Weight & Balance as the two cannot be used simultaneously.

1.1.2 Enhanced Weight & Balance

Enhanced W&B, released in March 2022, is the latest ForeFlight Mobile W&B tool *available* to all customers. Its features and how to use it are discussed throughout this guide.

With the exception of Business and MFB customers, Enhanced W&B can be toggled on or off in **More > Accounts > ForeFlight Labs**. Enhanced W&B is enabled by default for Business and MFB customers.

IMPORTANT: With the exception of the **Legacy Weight & Balance chapter** and where otherwise stated, all references to Weight & Balance in this guide refer to Enhanced Weight & Balance.

1.1.3 Integrated Weight & Balance

Integrated Weight & Balance, available only with a Performance-tier plan, adds Enhanced Weight & Balance to the Flights view. Integrated W&B copies payload and fuel amounts from the planned flight to W&B simplifying the flight planning process and keeping a record of your flight's W&B.

1. INTRODUCTION

1.2 Enhanced Weight & Balance Differences

When comparing Enhanced and Legacy W&B, there are four significant differences.

- **Aircraft Association** - Enhanced W&B profiles are a component of an aircraft profile and can be configured with the Aircraft view. Legacy W&B profiles are not associated with aircraft profiles.
- **Station Type Support** - Enhanced Weight & Balance adds the ability to specify station types. Specifying a station type limits what can be loaded in a station.

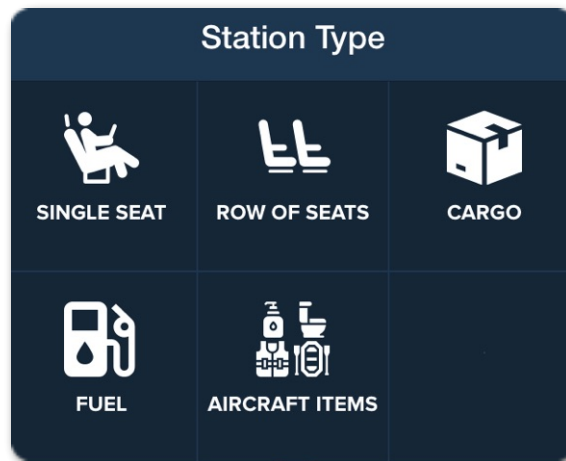

Enhanced W&B Station Types

- **Complex Configurations** - Enhanced Weight & Balance adds support for multiple fuel tanks, each with either a variable or a fixed arm. Legacy W&B only supports a single fuel tank with a variable arm.
- **Flights Integration** - Users with a Performance-tier account can calculate W&B from the Flights view when Enhanced W&B is enabled. Integrated W&B copies fuel and payload amounts from the flight to W&B. This feature reduces the amount of time necessary to compute W&B and saves W&B calculations with your flights.

1. INTRODUCTION

1.3 Converting from Legacy to Enhanced

When opening Weight & Balance for the first time after updating to ForeFlight Mobile version 14.2 or later, a pop-up appears with an option to enable Enhanced Weight & Balance. To defer to a later date, select **Not Right Now**.

Basic Plus, Pro Plus, and Performance Plus customers can enable or disable Enhanced W&B by selecting **More > Accounts > ForeFlight Labs > Enhanced Weight & Balance**. Business and MFB customers cannot manually disable this feature.

W&B profiles created with Legacy W&B can be converted to the enhanced format using **Migration Assistant**.

If Enhanced W&B is enabled and then later disabled, any profiles converted to or created with Enhanced W&B are saved for when the feature becomes required.

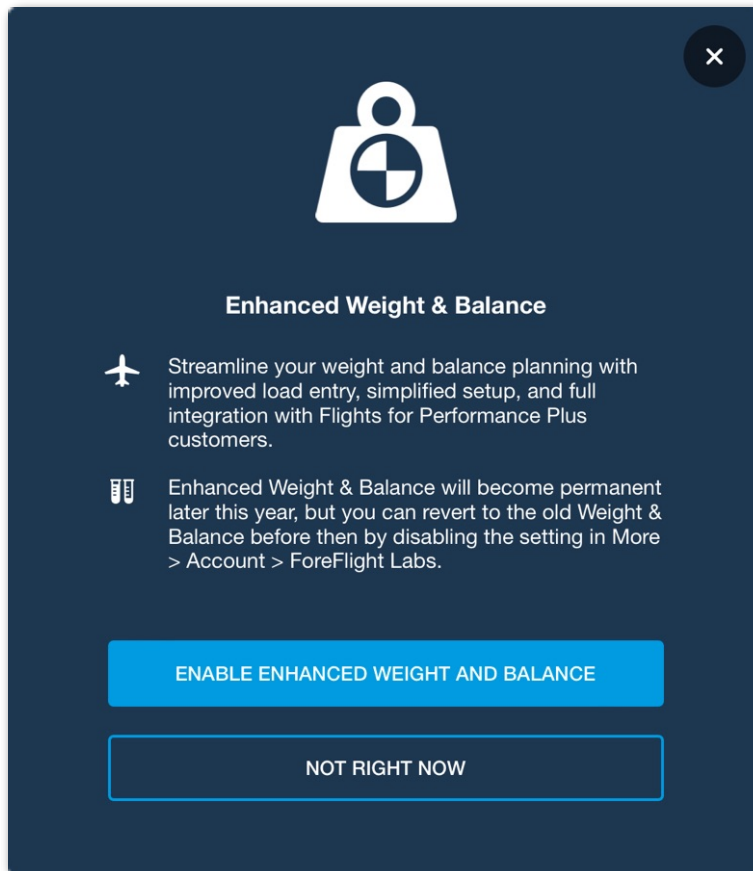

Enhanced Weight & Balance Pop-up

WEIGHT & BALANCE PROFILES

Weight & Balance profiles are a component of aircraft profiles and can be added with the Aircraft, Weight & Balance, or Flights views. Once a profile has been created with one view, it is available on all other views.

Aircraft can have several Weight and Balance (W&B) profiles. For example, if an aircraft has various configurations, removable equipment, or different CG limit envelopes (e.g., normal and utility), then it should have a separate W&B profile for each of these scenarios.

Once a W&B profile has been added, it can be selected when calculating W&B.

An overview of the steps required to complete a W&B profile are listed below. Click the links below for additional information.

1. Gather the **information** necessary to complete a W&B profile (e.g., station data, basic empty weight, forward and aft CG limits).
2. **Create an aircraft profile** (if required).
3. **Add a W&B profile** to the aircraft profile.
4. **Select a template.**
5. Ensure all **template sections** are complete.
 - If using a **prebuilt template**, enter the aircraft's basic empty CG and basic empty weight. Verify that the prepopulated station and CG limit data are accurate.
 - If using a **blank template**, complete all sections of the blank template.
 - If using a legacy template, use **Migration Assistant** to convert the profile.

4-Seat Arrangement	
Profile Name	4-Seat Arrangement
Basic Empty CG	133.2 in
Basic Empty Weight	2756 lbs
STATIONS	
Front Seats 2 Seats	80.5 in >
Rear Seats 2 Seats	118.1 in >
Tail Compartment Limit 200 lbs	142.8 in >
Main Tanks Limit 648 lbs	95 in >
Add Station	
FORWARD CG LIMITS	
89 in	3,800 lbs
85 in	3,400 lbs
84 in	2,800 lbs
84 in	2,300 lbs
Add Forward Limit	
AFT CG LIMITS	
93 in	2,300 lbs
93 in	3,800 lbs
Add Aft Limit	

**Complete W&B Profile
Aircraft View**

2. WEIGHT & BALANCE PROFILES

2.1 Weight & Balance Profile Required Information

The first step to creating any W&B profile is gathering the required information. All information should be available in the Limitations or Weight & Balance sections of the aircraft flight manual.

Information may be conveyed textually, graphically, or both. The image below depicts a graphical station diagram and how that information is transferred to the W&B template.

Before adding new W&B profile, gather all the information listed below.

- Basic Empty Weight from the aircraft's most recent weighing.
- Basic Empty CG from the aircraft's most recent weighing.
- Weight limits from the Limitation section of the aircraft's flight manual. For example, Baggage Compartment: limit 250 pounds.
- Forward and Aft CG Limits. Available in the Limitations or Weight & Balance section of the aircraft's flight manual. This information is often depicted as a two-dimensional envelope.
- Station arms and weight limits (as depicted below). This information is sometimes only provided textually via a list.

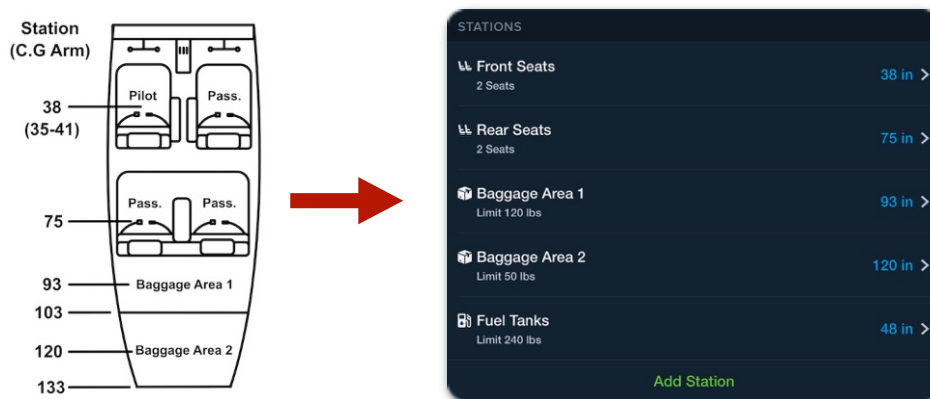

Copying Station Information from the Aircraft Flight Manual

NOTE: The information required to complete a Weight & Balance profile is often located on various pages of the aircraft flight manual.

2. WEIGHT & BALANCE PROFILES

2.2 Creating an Aircraft Profile

W&B profiles are a component of an aircraft profile. As such, an aircraft profile must exist before a W&B profile can be added. If the aircraft profile already exists, skip to [adding a W&B profile](#).

To create an aircraft profile:

1. Select **More** > **Aircraft** and tap the add aircraft **[+]** button in the upper toolbar.
2. In the General section of the aircraft profile, enter the aircraft's Tail Number and Type.
3. Verify the automatically populated information and edit as needed.

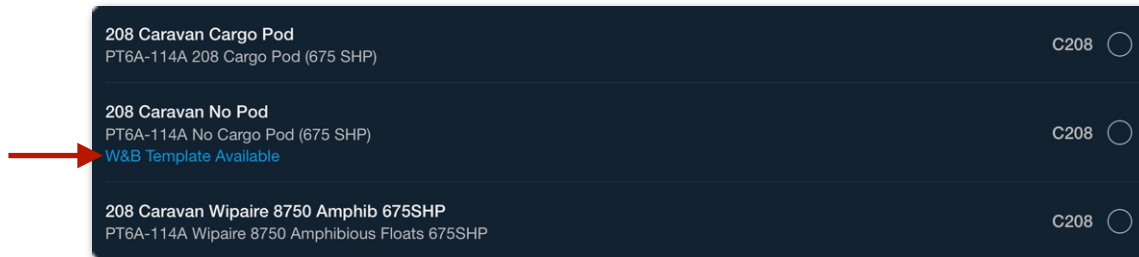

Selecting an Aircraft Type

NOTE: As depicted in the image above, when selecting an aircraft type, the “**W&B Template Available**” notation is displayed when a minimum of one **Prebuilt Template** exists for the aircraft type.

2. WEIGHT & BALANCE PROFILES

2.2.1 Aircraft Profile Weights Section

The Weights section of an aircraft profile contains manufacturer data based on the selected aircraft type. Information from this section is automatically incorporated into the W&B profile.

If the data in the Weights section is not accurate for your aircraft, verify that the correct aircraft type is selected with an emphasis on ensuring the proper aircraft variant, gross weight, or supplemental type certificate (STC) is selected.



WEIGHTS	
Weight Units	Pounds
Basic Empty Weight	1,500
Max Zero Fuel Weight	2,450
Max Ramp Weight	2,455
Max Takeoff Weight	2,450
Max Landing Weight	2,450

Aircraft Weights Section

Weight Definitions

Definitions for the values in the Weight section are found below.

- **Weight Units** allows an aircraft to use pounds or kilograms for flight planning and Weight & Balance purposes.
- **Basic Empty Weight (BEW)** is the weight of the airframe, engine(s), unusable fuel, and undrainable oil plus standard and optional equipment as specified in the equipment list. Basic Empty Weight is an auto-populated value and *should* be edited to reflect the actual basic empty weight from the aircraft's last weighing.
- **Max Zero Fuel Weight (MZFW)** is the maximum permissible weight of an aircraft loaded with cargo or passengers and with no disposable fuel. If the aircraft's flight manual does not define this limitation, set MZFW to match Max Takeoff Weight. MZFW is an auto-populated value and should be verified.
- **Max Ramp Weight (MRW)** is the maximum total weight of the loaded aircraft including all fuel. MRW is usually greater than the max takeoff weight due to the fuel that will be burned during the taxi and run-up operations.
- **Max Takeoff Weight (MTOW)** is the maximum allowable weight for takeoff and should be verified.
- **Max Landing Weight (MLDW)** is the maximum weight an aircraft is allowed to weigh at landing.

2. WEIGHT & BALANCE PROFILES

2.3 Adding a Weight & Balance Profile

W&B profiles can be added with the Aircraft, Weight & Balance, or Flights view. Once a profile is added with one view, it is accessible from the others.

2.3.1 Adding Profiles with the Aircraft View

To add a profile using the Aircraft view:

1. Tap **More** > **Aircraft** and select an existing aircraft profile.
2. Scroll to the Weight & Balance section.
3. Tap **Add W&B Profile** and **select a template**.

2.3.2 Adding Profiles with the Weight & Balance View

To add a profile using the Weight & Balance view:

1. Tap **More** > **Weight & Balance**.
2. Tap the profile menu in the upper toolbar (see image below).
3. Tap the Add Profile **[+]** button in the pop-up.
4. Select an aircraft.
5. **Select a template**.

Profile Menu

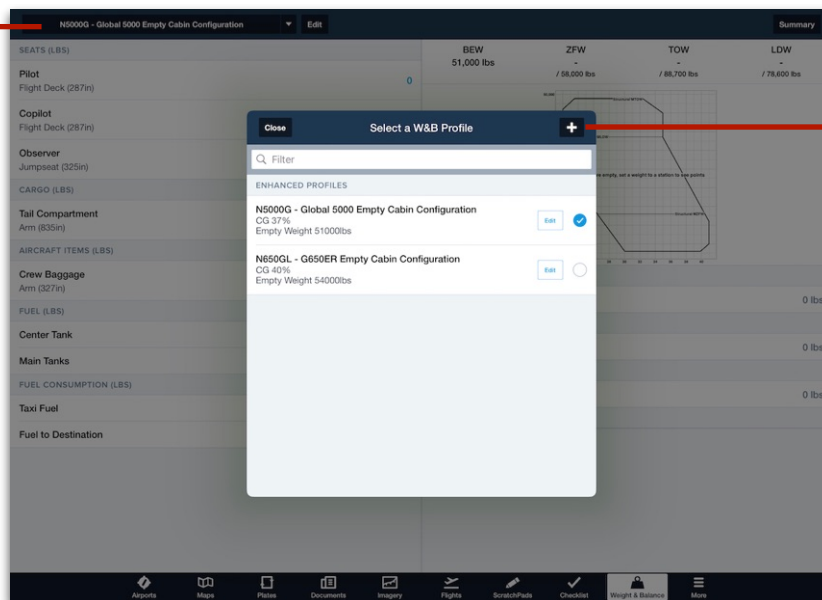

Add Profile Button

Adding Profiles with the Weight & Balance view

2. WEIGHT & BALANCE PROFILES

2.3.3 Adding Profiles with the Flights View

Adding a W&B profile with the Flights view can only be done with a Performance-tier account. If planning a flight with an aircraft that *does not* already have a W&B profile, follow the steps below to add a W&B profile.

1. Tap **More > Flights** and select a flight.
2. Scroll to the Payload section and tap **Weight and Balance**.
3. Tap the Add Profile **[+]** button in the pop-up.
4. **Select a template.**

Adding Additional Profiles with the Flights View

If the flight's aircraft already has an existing W&B profile, additional profiles can be added by following the steps below.

1. Tap **More > Flights** and select a flight.
2. Scroll to the Payload section and tap **Weight and Balance**.
3. Tap the selected **W&B Profile** at the top of the view (see image below).
4. Tap the Add Profile **[+]** button in the pop-up.
5. **Select a template.**

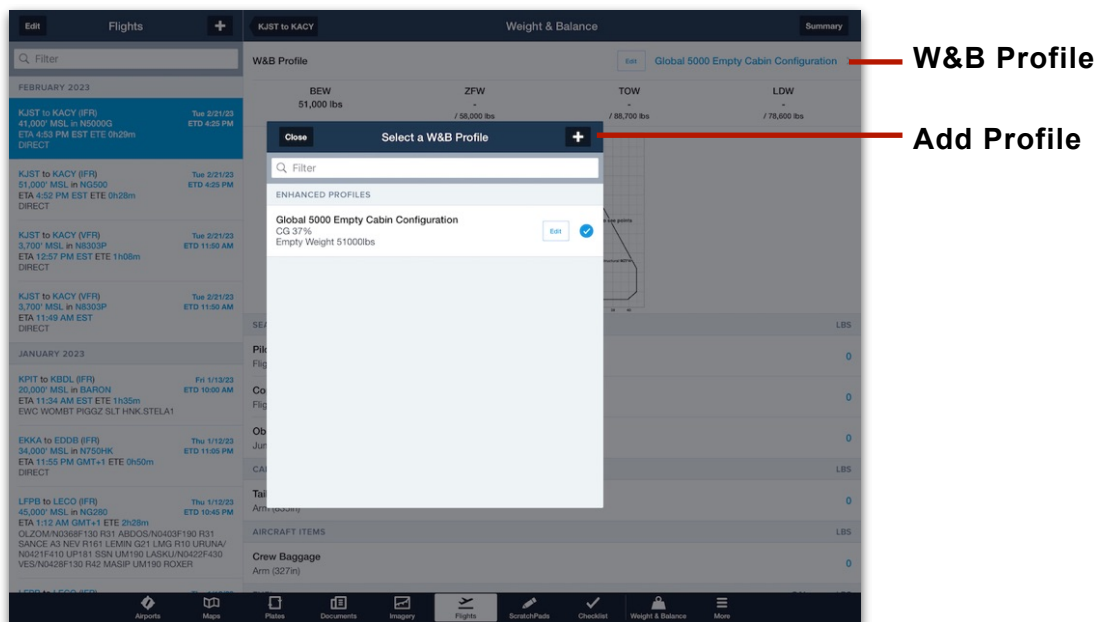

Adding Additional Profiles with the Flights View

2. WEIGHT & BALANCE PROFILES

2.4 Types of Templates

Templates are used to complete a Weight & Balance profile. There are three different types of templates available. Although the three types of templates have similar information and formatting, they have different amounts of pre-filled data. See [Weight & Balance Template](#) for additional information. The three types of templates are listed below.

- **Prebuilt templates** contain prepopulated manufacturer W&B data. ForeFlight offers hundreds of prebuilt templates for popular aircraft, requiring only the aircraft's basic empty weight and CG to complete. See [Prebuilt Templates](#) for additional information.
- **Blank templates** should be selected when a prebuilt template does not exist for the aircraft. These templates are completed manually by entering all station, limit, and weight data from the aircraft flight manual.
- **Legacy templates** are W&B profiles that were created with [Legacy Weight & Balance](#). These profiles can be converted to the latest format by verifying empty weight, station location, and limits data with [Migration Assistant](#).

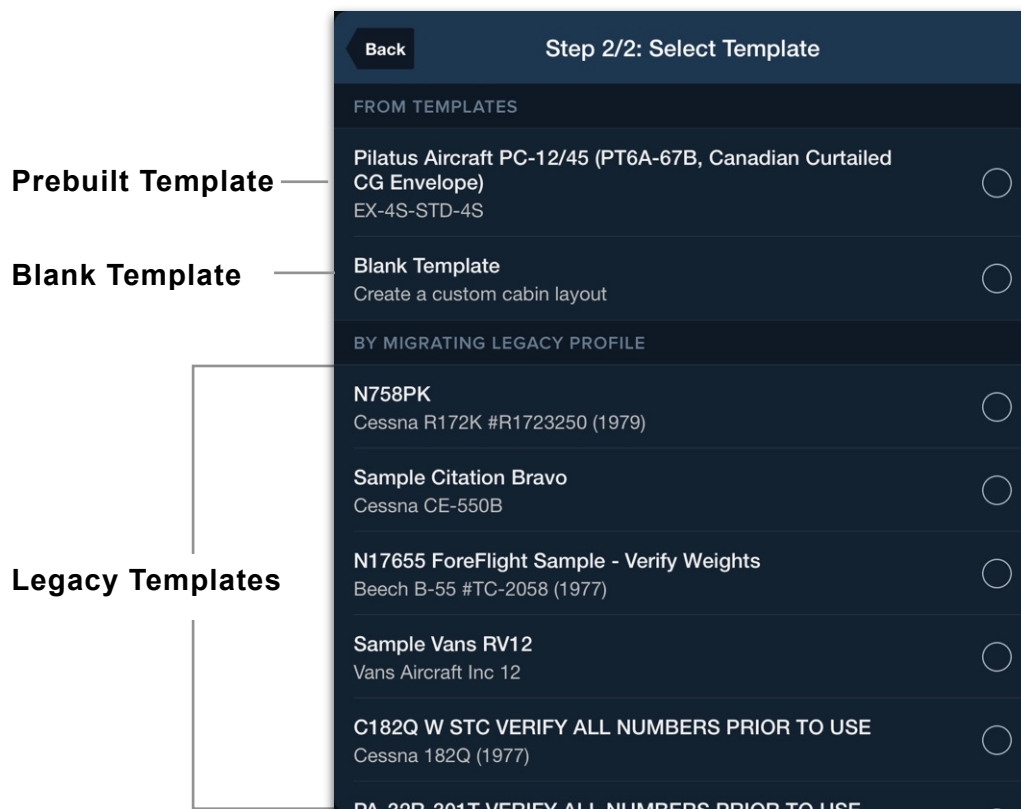

2. WEIGHT & BALANCE PROFILES

2.4.1 Prebuilt Templates

Prebuilt templates contain prepopulated manufacturer W&B data and are available for hundreds of popular aircraft types. To determine if a prebuilt template exists for your aircraft, **add a new weight & balance profile** and look for templates above the *Blank Template*.

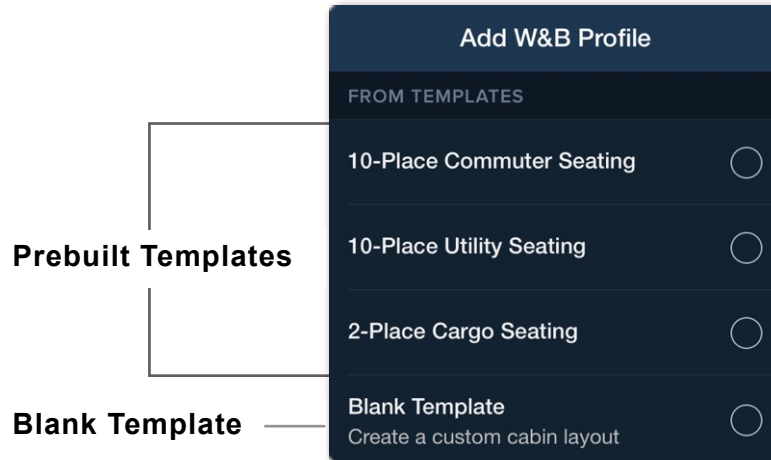

If no templates are above the Blank Template, a prebuilt template does not exist for the selected aircraft type.

Completing a Prebuilt Template

Prebuilt templates only require basic empty CG and basic empty weight to complete. In other words, stations (e.g., seats, fuel, and cargo) and CG limits are automatically completed with a prebuilt template. Each section only needs to be reviewed and edited if necessary.

The image shows a form titled "N8303P 4 Seat Arrangement". The form has a dark header with a back arrow, the aircraft type "N8303P", the title "4 Seat Arrangement", and a share icon. Below the header, there are three sections:

- Profile Name**: 4 Seat Arrangement
- Basic Empty CG**: Required
- Basic Empty Weight**: USE 2756 Required

Prebuilt Template - General Section

NOTE: The “Use [basic empty weight]” button is provided for reference only. Your aircraft’s actual basic empty weight from its last weighing should be entered in this field.

2. WEIGHT & BALANCE PROFILES

2.4.2 Blank Templates

Blank templates are available for all aircraft and should be selected when prebuilt and legacy templates do not exist. Each section of a blank template must be manually completed.

All blank templates start with a single row of seats for the cockpit, a single cargo station, and a single fuel tank. Tap **Add Station** to add additional seats, cargo compartments, fuel tanks, or aircraft items.

Blank templates also start with a single forward and aft CG limit. A minimum of two forward CG limits and two aft CG limits is required to define the aircraft's forward and aft CG envelope. Tap **Add Forward Limit** or **Add Aft Limit** to add additional CG limit data points.

See the **Weight & Balance Template** section for additional information.

The screenshot shows a mobile application interface for a weight and balance profile. At the top, the aircraft registration 'N453TC' and the profile name 'My Profile' are displayed. Below this, there are several sections:

- Profile Name:** My Profile
- Basic Empty CG:** 0 in
- Basic Empty Weight:** A button labeled 'USE 3925' and the text 'Required'.
- STATIONS:** A list of stations with their respective CG values and a right-pointing arrow:
 - Cockpit:** 2 Seats, 0 in >
 - Cargo Station 1:** 0 in >
 - Fuel Tanks:** 0 in >
- Add Station:** A green button to add more stations.
- FORWARD CG LIMITS:** A section with a value of 0 in and 0 lbs, and a green button labeled 'Add Forward Limit'.
- AFT CG LIMITS:** A section with a value of 0 in and 0 lbs, and a green button labeled 'Add Aft Limit'.

Blank Template

2. WEIGHT & BALANCE PROFILES

2.4.3 Legacy Templates

Legacy templates are W&B profiles that were created with **Legacy Weight & Balance**. These profiles can be converted to the latest format by verifying empty weight, CG, station location, and limits with **Migration Assistant**.

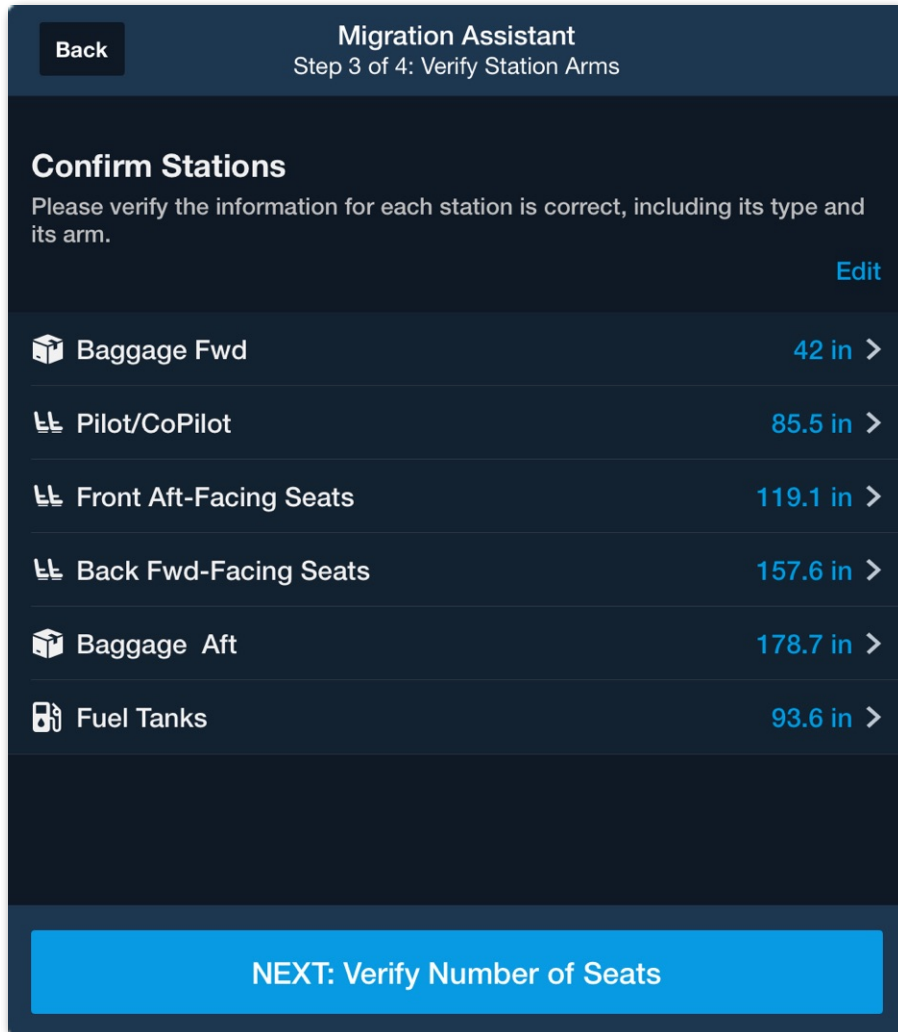

Migration Assistant

2. WEIGHT & BALANCE PROFILES

2.5 Weight & Balance Template Design

The Weight & Balance template contains four sections. Once all sections are complete, the profile can be used to calculate W&B. Tap the section names on this page for instructions on how to complete the section.

The screenshot shows the configuration screen for a 4-Seat Standard Arrangement. The sections are:

- GENERAL:** Profile Name (4-Seat Standard Arrangement), Basic Empty CG (0 in), Basic Empty Weight (USE 1393 Required).
- STATIONS:** Front Seats (2 Seats, 37 in >), Rear Seats (2 Seats, 73 in >), Tail Compartment (Limit 120 lbs, 95 in >), Tail Compartment (Limit 50 lbs, 123 in >), Fuel Tanks (Limit 240 lbs, 48 in >), Add Station.
- CG LIMITS:** FORWARD CG LIMITS (38.5 in, 2,300 lbs; 35 in, 1,950 lbs; 35 in, 1,500 lbs; Add Forward Limit); AFT CG LIMITS (47.3 in, 1,500 lbs; 47.3 in, 2,300 lbs; Add Aft Limit).
- ENVELOPE PREVIEW:** A graph showing Weight (lbs) vs. CG (in) with a line connecting the four limit points and a 'NEW' button.

Tap a Section Name for Additional Information

2. WEIGHT & BALANCE PROFILES

2.5.1 General Section

The General section contains the W&B profile name, the aircraft's basic empty CG, and basic empty weight. Each field is described in detail below.

Profile Name	10-Place Commuter Seating
Basic Empty CG	170 in
Basic Empty Weight	3925 lbs

General Section

Profile Name

The profile name describes the W&B profile. This user-editable field supports alphanumeric and special characters and is used to distinguish profiles from one another. Example profile names are listed below.

- Standard Configuration
- 4 Passenger with Aft Seats Removed
- N12345 - Normal
- N12345 - Aerobatic
- N12345 - Utility

Basic Empty CG

The aircraft's basic empty CG, as recorded on the aircraft's most recent weighing, should be entered in the Basic Empty CG field. The aircraft's unit of measure (inches, feet, meters, millimeters, and centimeters) is depicted to the right of the Basic Empty CG label.

To change the unit of measure, select the **Aircraft** view. In the General section at the top of the aircraft profile, select **Length Units** and choose the appropriate length unit for the aircraft. Inches, feet, meters, millimeters, and centimeters are supported. If a CG is entered and the unit of measure is later changed, the Basic Empty CG will be automatically converted to the new unit.

Basic Empty Weight

The aircraft's Basic Empty Weight (BEW), as recorded on the aircraft's most recent weighing, should be entered in the Basic Empty Weight field. Weight & Balance supports pounds (lbs.) and kilograms (kg). To change the unit of weight, select the **Aircraft** view > **Weight Units**, and select the appropriate weight unit for the aircraft.

2. WEIGHT & BALANCE PROFILES

2.5.2 Stations Section

The Stations section defines items along the *longitudinal* axis that change weight on a per-flight basis, such as passenger and crew seats, cargo compartments, fuel tanks, and other aircraft items.

When using a prebuilt template, each station's type, description, location (arm), and maximum weight limit are automatically populated and should be verified. If a prebuilt template's station differs from your aircraft's flight manual, manually edit the station description, arm, or weight limit as needed.

When using a blank template, a row of seats (consisting of two cockpit seats), a cargo station, and a single fuel tank are added by default. Tap **Add Station** to add additional seats, cargo compartments, fuel tanks, and aircraft items.

See **Station Types** for additional information.

STATIONS	
Flight Deck 2 Seats	135.5 in >
Row 1 2 Seats	169.9 in >
Single Seat 1 Seat	185.9 in >
Row 2 2 Seats	201.9 in >
Single Seat 1 Seat	217.9 in >
Row 3 2 Seats	233.9 in >
Tail Compartment Limit 325 lbs	296 in >
Main Tanks Limit 2224 lbs	Variable >
Add Station	

Example Station Section

2. WEIGHT & BALANCE PROFILES

2.5.3 CG Limits Section

To ensure the aircraft is operated within limits, the aircraft's forward and aft CG limits must be defined. Forward and aft CG limits are generally found in the Weight & Balance or Limitations section of the aircraft's flight manual.

Basic CG Envelopes

As depicted in the image below, some aircraft may not provide a graphical CG envelope and instead only provide a single limit for forward and aft CG. For this type of aircraft, four data points are needed. Tap **Add Forward Limit** and **Add Aft Limit** until there are two data points of each type.

Begin by entering the forward CG limit for the aircraft's maximum weight, followed by the forward limit for the minimum weight. If the aircraft does not have a defined minimum weight, use the aircraft's basic empty weight or an equivalent value.

The order of the rows does not affect the profile. However, entering maximum weights near the top and minimum weights near the bottom helps with the visualization of the CG envelope.

Sample Basic CG Envelope

Forward CG Limit: 78.3 in
Aft CG Limit: 108.5 in
Max Gross Weight: 3,200 lbs
Basic Empty Weight 1,785.2 lbs



FORWARD CG LIMITS	
78.3 in	3,200 lbs
78.3 in	1,800 lbs
Add Forward Limit	
AFT CG LIMITS	
108.5 in	3,200 lbs
108.5 in	1,800 lbs
Add Aft Limit	

Basic CG Envelope

NOTE: CG limits must contain at least two forward and two aft data points that define the limits at the aircraft's maximum and minimum weight.

2. WEIGHT & BALANCE PROFILES

Complex CG Envelopes

Complex CG envelopes are often depicted in flight manuals graphically as the limits can change with aircraft weight. CG envelopes are defined by each bend in the envelope (depicted with the colored numbers in the image below).

To complete the CG limits section for this type of aircraft, the weight and its corresponding arm at each bend in the envelope should be added. Forward CG limits are typically on the left side of the graph, and aft CG limits are on the right.

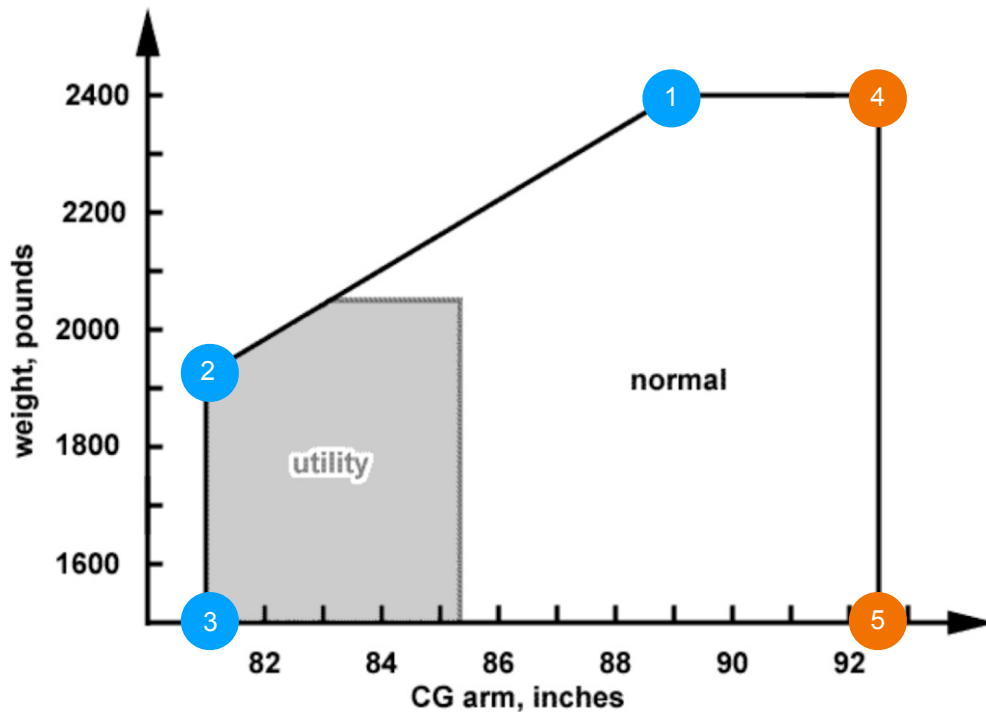

FORWARD CG LIMITS		
1	Max Gross Weight - FWD limit	89 in 2,400 lbs
2	Limit changes with weight (bend)	81 in 1,920 lbs
3	Min Gross Weight - FWD limit	81 in 1,500 lbs
Add Forward Limit		
AFT CG LIMITS		
4	Max Gross Weight - AFT limit	92.5 in 2,400 lbs
5	Min Gross Weight - AFT limit	92.5 in 1,500 lbs
Add Aft Limit		

2. WEIGHT & BALANCE PROFILES

Converting Weight and Moment

Some CG envelopes use Weight & Moment to define the envelope. If your CG envelope is defined by Weight & Moment, the moments must be converted to arm before they can be entered in ForeFlight. To convert a moment value to arm, divide the full moment value by its corresponding weight.

For example, using the image below, the following steps were completed to determine the arm value of the forward CG limit at maximum takeoff weight:

1. Locate the aircraft's forward moment limit (88.2 pound-inches) at the maximum weight (2,300 pounds)
2. Since the table shows the moment is divided by 1000 (MOMENT/1000), multiply the moment by 1000 to determine the full moment (88.2 x 1000 = 88,200 pound-inches).
3. Divide the full moment (88,200 found inches) by the corresponding weight (2,300 pounds) to determine the arm in inches. (88,200 ÷ 2,300 = 38.35 inches).
4. Repeat steps 1-3 for each CG limit point (depicted as blue dots).

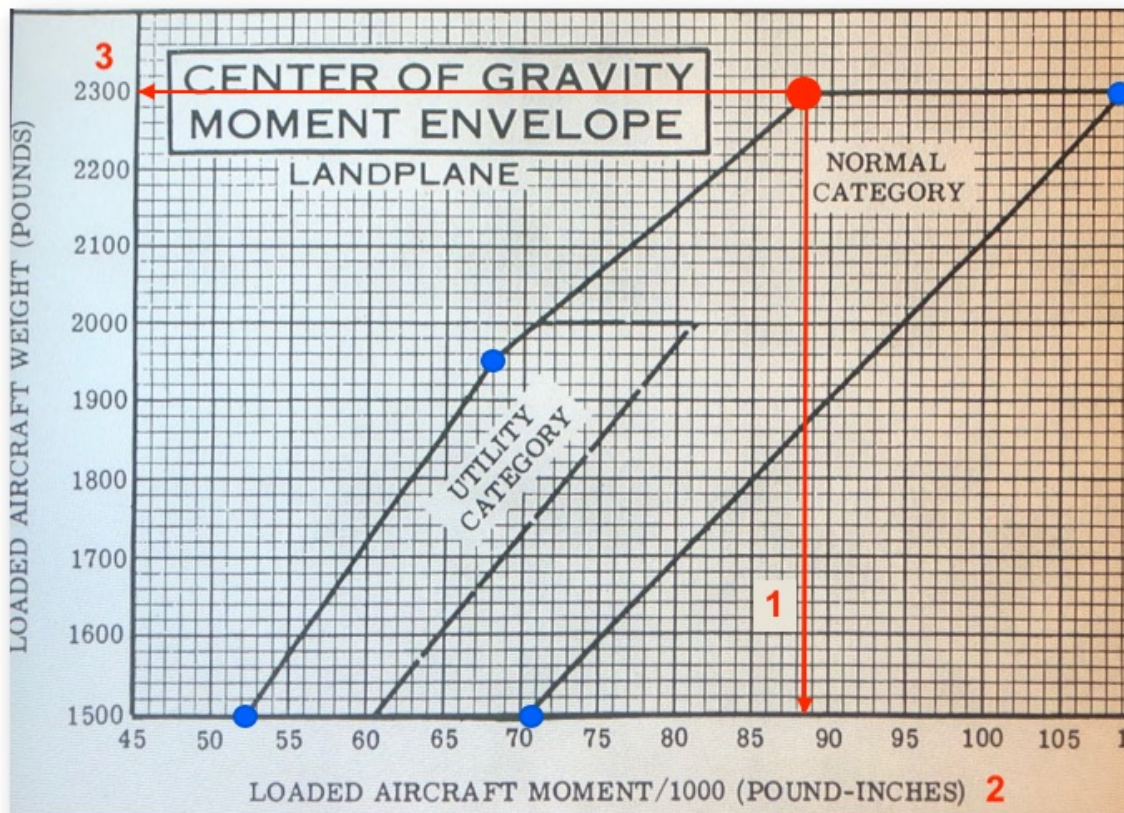

2. WEIGHT & BALANCE PROFILES

2.5.4 Default Curtailment Options

The Default Curtailment Options section allows MFB and multi-pilot business accounts to select if **curtailment tools** should be enabled by default when calculating weight and balance. Standard Weights Curtailment is currently the only curtailment tool available.

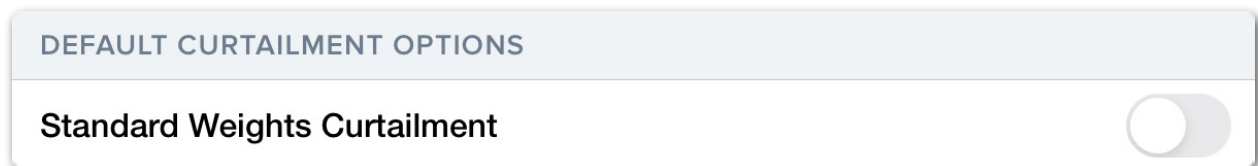

Default Curtailment Options Section

Standard Weights Curtailment

When this setting is enabled, the **Standard Weights** toggle is on by default when calculating a new weight and balance. See **Curtailment Options** for more information.

2. WEIGHT & BALANCE PROFILES

2.5.5 Envelope Preview

The Envelope Preview depicts the aircraft's limits and basic empty weight (BEW) as entered by the user. This graph should resemble the graph in the aircraft flight manual (if applicable).

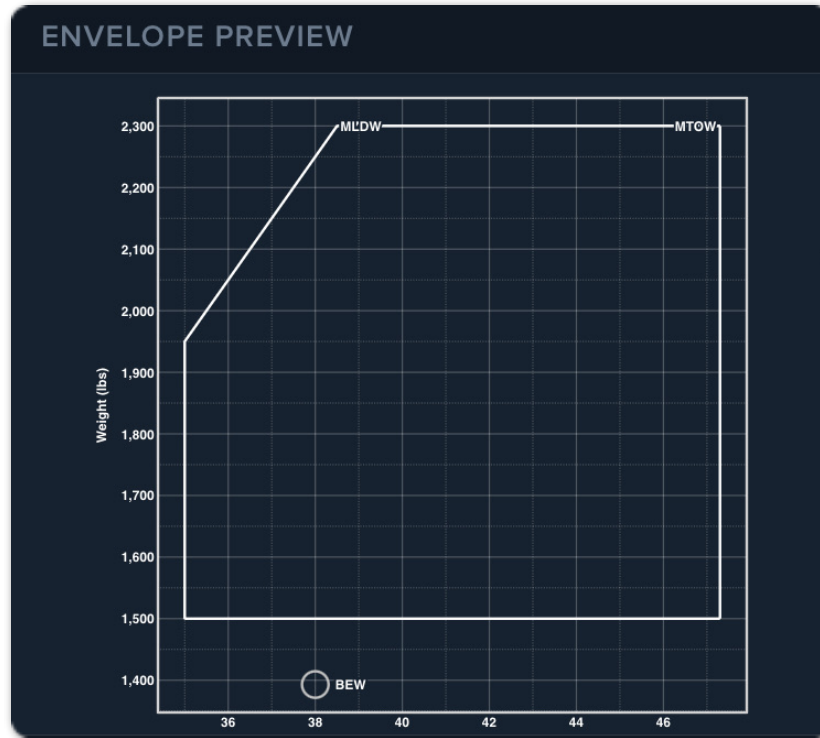

Envelope Preview

2.5.6 Use %MAC

The Use %MAC option allows you to create a Weight & Balance profile using the aircraft's mean aerodynamic chord (MAC).

Enabling %MAC adds the leading edge mean aerodynamic chord (LEMAC) and MAC field. Enabling %MAC also converts CG limits from a station arm (in) to use %MAC.

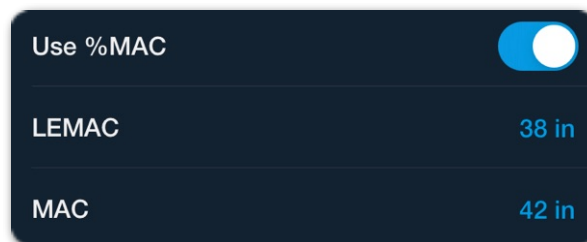

Use %MAC

2. WEIGHT & BALANCE PROFILES

2.5.7 Gear Retraction Moment Change

Aircraft with retractable gear may provide information about how the gear's movement affects aircraft CG. If the aircraft provides this information, enter the **Gear Retraction Moment Change** in the weight and balance profile.

Use %MAC

Gear Retraction Moment Change **-8,307 in-lbs**

Gear Retraction Setting

The gear retraction moment is the change in CG that occurs as a result of the raising and lowering of the landing gear. When **calculating weight and balance**, this shift in CG is depicted as a short horizontal line next to the takeoff and landing weight. The example image below depicts CG shift for an aircraft with gear that swings forward when raised.

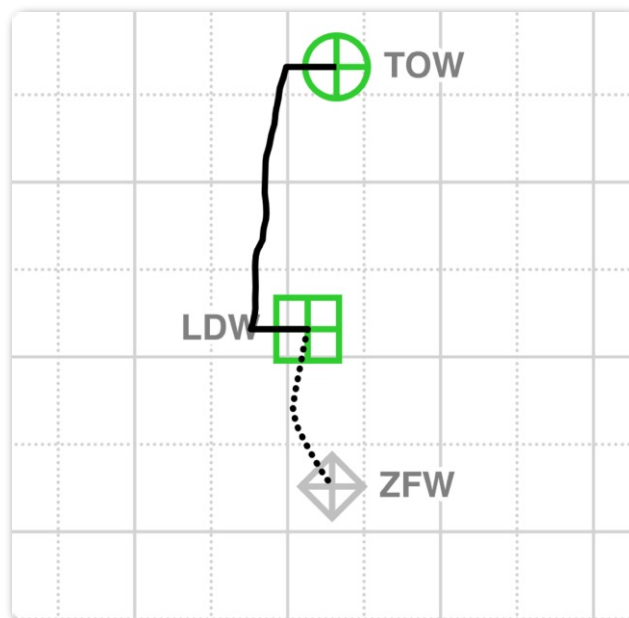

Shift in CG due to gear movement

2. WEIGHT & BALANCE PROFILES

2.6 Types of Weight & Balance Stations

When adding a station, the station type must be specified. The station type determines what can be loaded in the station when calculating W&B. Each station type is described in detail in this section.

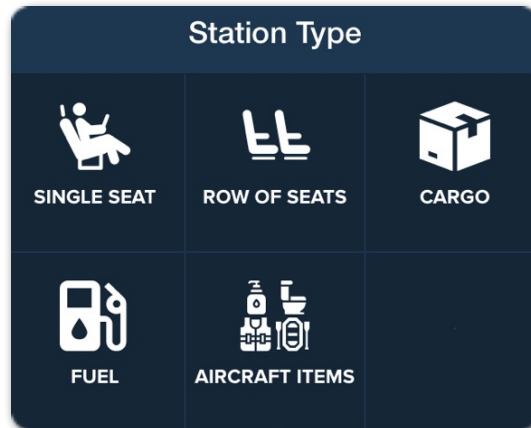

Station Types

2.6.1 Single Seat

Single Seat should be selected when a single passenger or crew seat exists in a given row. When calculating W&B, crew, passengers, passengers with infants, and cargo can be loaded in a single seat.

Provide a descriptive name for the single seat and enter the seat's arm and weight limit (if applicable).

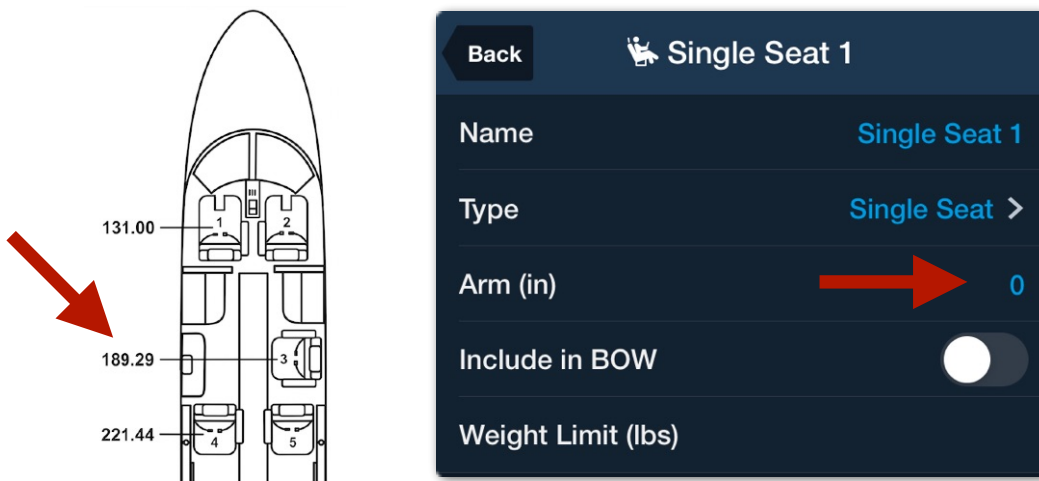

Example of a Single Seat

2. WEIGHT & BALANCE PROFILES

2.6.2 Row of Seats

Row of Seats should be selected when two or more seats share the same arm. When calculating W&B, crew, passengers, passengers with infants, and cargo can be loaded in a row of seats.

Provide a descriptive name for the row of seats (e.g., Back Seats) and if applicable, a maximum weight limit for the row.

Select **Add Seat** to add additional seats to the row or swipe right to left across a seat to delete it. For example, if there are four seats in a row, select **Add Seat** until there are four items listed under the *Seats In This Row* section.

Provide descriptive names for each seat. For example, left and right seats or Seats 1A, 2A, 3A, 4A. Include a seat weight limit for each individual seat (if applicable).

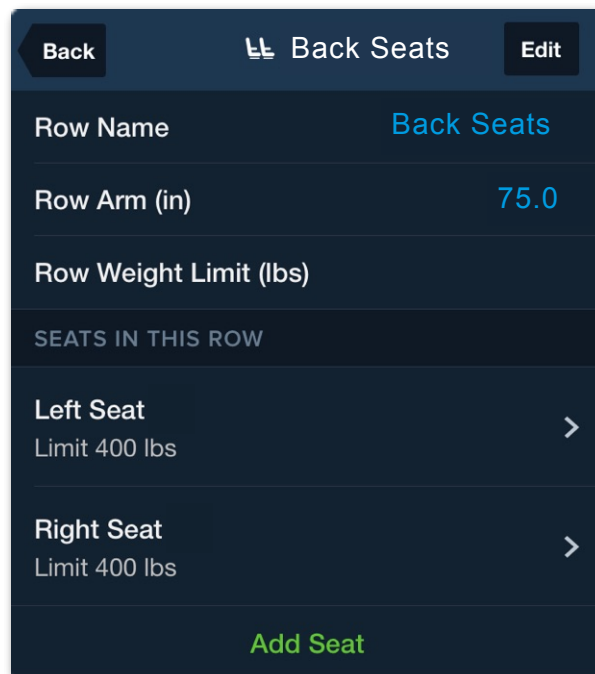
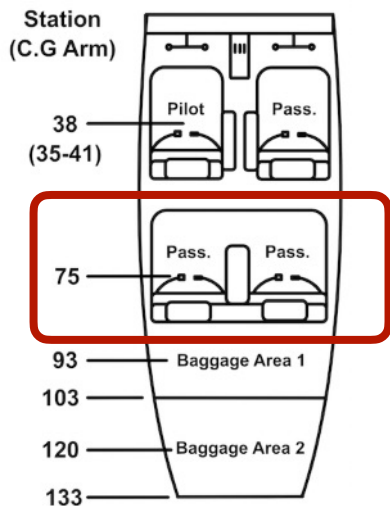

Adding a Row of Seats

2. WEIGHT & BALANCE PROFILES

2.6.3 Cargo

A cargo station should be added for each cargo compartment with a unique arm.

When adding cargo, enter a descriptive name for the cargo compartment, the station's arm, and a weight limit (if applicable).

Generally, the cargo compartment's arm is at the center of the cargo compartment.

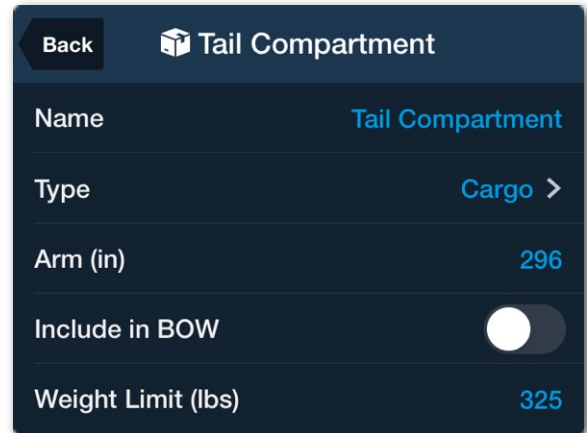

Back	Tail Compartment
Name	Tail Compartment
Type	Cargo >
Arm (in)	296
Include in BOW	<input type="checkbox"/>
Weight Limit (lbs)	325

Cargo Station

2.6.4 Aircraft Items

Aircraft Items should be selected for items that can vary in weight with each flight but are not used to store cargo, fuel, or people. When adding Aircraft Items, specify a descriptive name, the arm, and applicable weight limits.

Example aircraft items include:

- Wardrobe Closets
- Galley Storage
- Navigational Chart Cases
- Cabinets
- Lavatory Storage

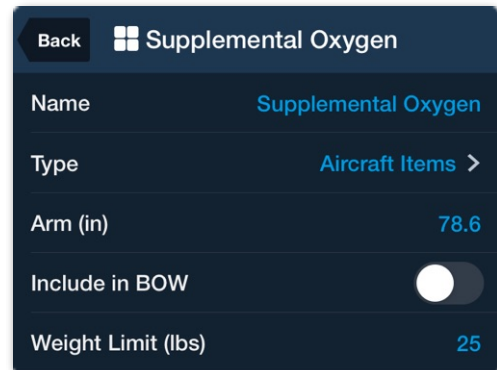

Back	Supplemental Oxygen
Name	Supplemental Oxygen
Type	Aircraft Items >
Arm (in)	78.6
Include in BOW	<input type="checkbox"/>
Weight Limit (lbs)	25

Aircraft Items

2.6.5 Fuel Tanks

Weight & Balance supports aircraft with multiple fuel tanks and multiple fuel moment tables (variable arms). Fuel sequencing is *only* supported if the weighted balance template was *prebuilt* by ForeFlight.

Fuel with Fixed Arms

To add fuel tanks with a fixed arm, select **Add Station** >  **Fuel** and enter the fuel tank's name, arm, and weight limit. Repeat these steps for each *fixed-arm* fuel tank.

2. WEIGHT & BALANCE PROFILES

Fuel with Variable Arms

If an aircraft does not consume fuel symmetrically, it should have a fuel moment table in the flight manual (as depicted in the image below). If your aircraft has a fuel moment table, toggle on **Variable Fuel Station**.

When Variable Fuel Station is enabled, ForeFlight displays the Fuel Moment Table. The Fuel Moment Table specifies various fuel loads and corresponding moments. Copy the values from the flight manual to ForeFlight. Fuel weights and moments are not required to be entered in order, but it is recommended. Ensure the fuel moment table units of measure (lbs, in, etc.) match what is entered into the ForeFlight Fuel Moment Table.

NOTE: If your aircraft utilizes a fuel schedule and a prebuilt template exists for your aircraft, fuel scheduling, is respected. Fuel scheduling is not supported when creating a profile from a blank template.

To add a Fuel Moment Table:

1. Select the **Variable Fuel Station** option.
2. Select **Add Fuel Moment** to add additional rows to the table.
3. Manually enter the fuel Weight & corresponding *moment* for *all* rows in the flight manual's Moment Table.

FUEL LOADING WEIGHT AND MOMENT TABLE (U.S. UNITS)

WING TANK FUEL	
WEIGHT (POUNDS)	MOMENT/100 (INCH-POUNDS)
100	311.72
200	619.45
300	923.80
400	1226.16
500	1527.43
600	1828.57
700	2130.74
800	2433.92
900	2737.96
1000	3042.77
1100	3348.26
1200	3654.36
1300	3961.04
1400	4268.25
1500	4575.96
1600	4884.49
1700	5193.78
1800	5503.69
1900	5814.20
2000	6125.28
2100	6436.95
2200	6749.18
2300	7061.97
2400	7375.33
2500	7689.28
2600	8003.82
2700	8318.98
2800	8634.75
2900	8951.12
3000	9268.10

WING TANK FUEL (CONTINUED)	
WEIGHT (POUNDS)	MOMENT/100 (INCH-POUNDS)
3100	9585.70
3200	9903.94
3300	10222.86
3400	10542.51
3500	10863.04
3600	11184.55
3700	11506.99
3800	11830.34
3900	12154.57
4000	12479.66
4100	12805.61
4200	13132.44
4300	13460.18
4400	13788.90
4500	14118.64
4600	14449.44
4700	14781.30
4800	15114.28
4900	15448.43
5000	15783.77
5100	16120.39
5200	16458.32
5300	16797.63
5400	17138.14
5500	17479.77
5600	17822.53
5700	18166.50
5800	18511.85
5828	18608.83

2. WEIGHT & BALANCE PROFILES

Fuel Density

When calculating Weight & Balance, the weight of fuel is determined by the type. Fuel Type and Fuel Units are specified in the aircraft profile fuel section by selecting **More > Aircraft**.

It is not possible to specify a custom fuel density. ForeFlight automatically converts fuel density to weight as depicted below.

- **Jet-A** - 6.75 pounds per gallon
- **Jet-A Prist** - 6.75 pounds per gallon
- **100LL** - 6.0 pounds per gallon
- **Other** - 6.0 pounds per gallon

2.6.6 Include in BOW

Each station type (other than fuel) has an **Include in BOW** checkbox. Selecting the checkbox adds a *Weight* field to the pop-up.

Items that do not vary weight between flights and are not included in the aircraft's basic operating weight should use this option. For example, a first aid bag, rescue equipment, or supplemental raft that is always onboard the aircraft can be added to the profile as an Aircraft Item with the *Include in BOW* box checked.

When Include in BOW is selected and a weight is added, the item becomes inactive while flight planning and the weight is added to the aircraft's basic operating weight.

2. WEIGHT & BALANCE PROFILES

2.6.7 Station Notes

Notes are designed to assist pilots with completing a Weight & balance profile. Each station type other than the fuel station includes an option to add notes. To add a note, tap the note section when editing or adding a station.

When a profile has notes, they are depicted near the bottom of the seats, cargo, or aircraft items list as applicable. Tap the note when calculating Weight & balance to review its contents.

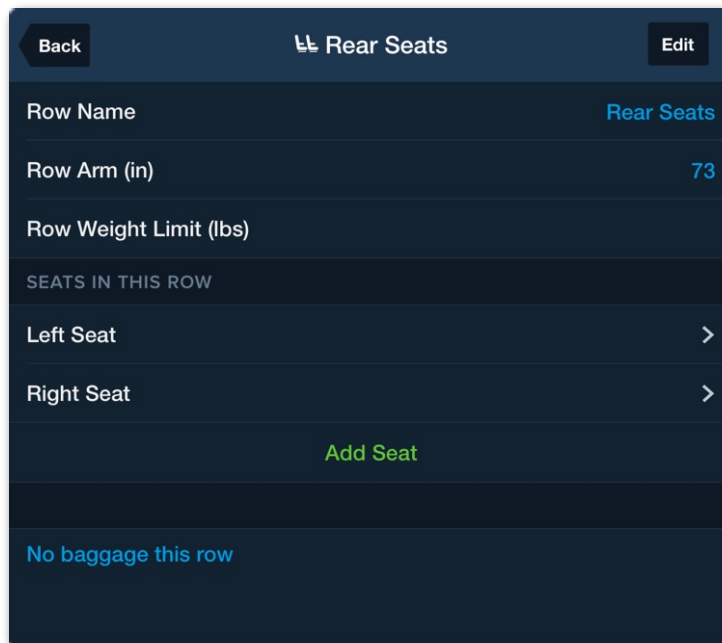

Adding a Note

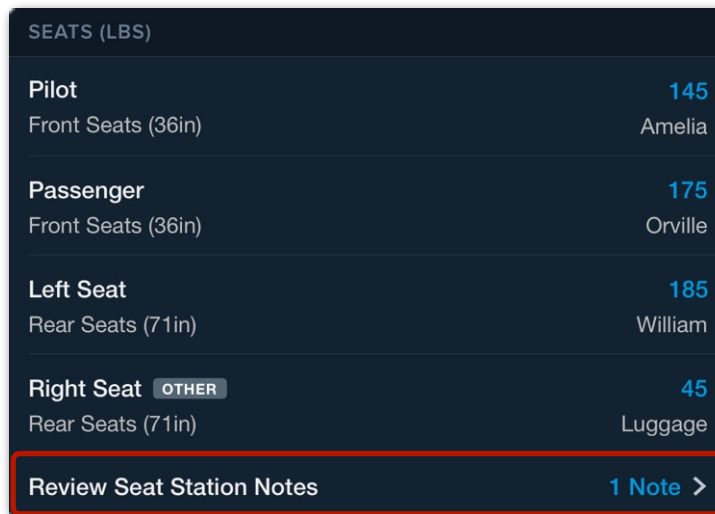

Viewing Notes

MIGRATION ASSISTANT

Weight & Balance profiles created with **Legacy Weight & Balance** (legacy profiles) must be updated before they can be used with **Enhanced Weight & Balance**. To convert a legacy profile to the new format, ForeFlight Mobile offers a Migration Assistant. Migration Assistant is *not* available for ForeFlight Web.

King Air C90GT Sample...

Aircraft load is within limits

IDENTIFICATION	
Tail Number	King Air C90GT
Profile Name	Sample Only - Not For Use In Flight
Make	Raytheon Aircraft Company
Model	C90GT #LJ-####
UNITS	
Length	in
Weight	lb
%MAC	<input type="checkbox"/>
Additional Fuel Unit	gal
Fuel Type	Jet-A
Fuel Density	6.7 lb/gal
STATIONS	
Cockpit (limit 600 lb)	129 in
Forward Cabinet	153 in
Front Aft-Facing Seats	168 in
Back Forward Facing Seats	218 in
Aft Cabinet	226 in
Sideways Seat	243 in
Under Seat Drawer	243 in
Lavatory Seat	285 in
Baggage Area (limit 350 lb)	277 in
Fuel Tanks	Moment table
EMPTY AIRCRAFT	
Weight	6,717 lb
CG	149.1 in

GRAPH

Weight vs. CG plot showing takeoff and landing points. Legend: takeoff (green circle), landing (green square), zero fuel (grey diamond), landing limit (dashed line).

RAMP (MAX 10,160 LB)	
Ramp Weight	9,967 lb
Ramp Fuel	328.36 gal Jet-A
TAKEOFF (MAX 10,100 LB)	
Takeoff Weight	9,907 lb
CG (151.5 to 160)	154.6 in
Takeoff Fuel	319.4 gal Jet-A
LANDING (MAX 9,600 LB)	
Landing Weight	8,433 lb
CG (146.8 to 160)	152.7 in
Fuel Remaining	99.4 gal Jet-A
ZERO FUEL	
Zero Fuel Weight	7,767 lb
CG (144.8 to 160)	154.6 in
STATION LIMITS	
Cockpit	330 of 600 lb
Baggage Area	140 of 350 lb

Bottom Navigation Bar: Airports, Maps, Plates, Documents, Flights, Imagery, ScratchPads, Checklist, Weight & Balance, More

Legacy Weight & Balance

3. MIGRATION ASSISTANT

Migration Assistant updates legacy profiles by copying weight, station, and limit information to the new format. Station type is automatically determined by analyzing the legacy profile's station names. For example, a legacy profile having a station named "Aft Cabinet" is presumed to be an *Aircraft Item*. Similarly, a station named "Front Aft-Facing Seats" is presumed to be a row of seats.

To convert a legacy profile *with ForeFlight Mobile*:

1. Add a Weight & Balance profile from the Weight & Balance or Aircraft view.
2. Select the appropriate legacy profile.
3. Select a corresponding aircraft (if using the W&B view).
4. Select a default Weight & aircraft unit (if **discrepancies** exist).
5. Verify Migration Assistant correctly assigned the appropriate station types and arms.
6. Verify the number of seats for each row of seats.
7. Select **Done**.

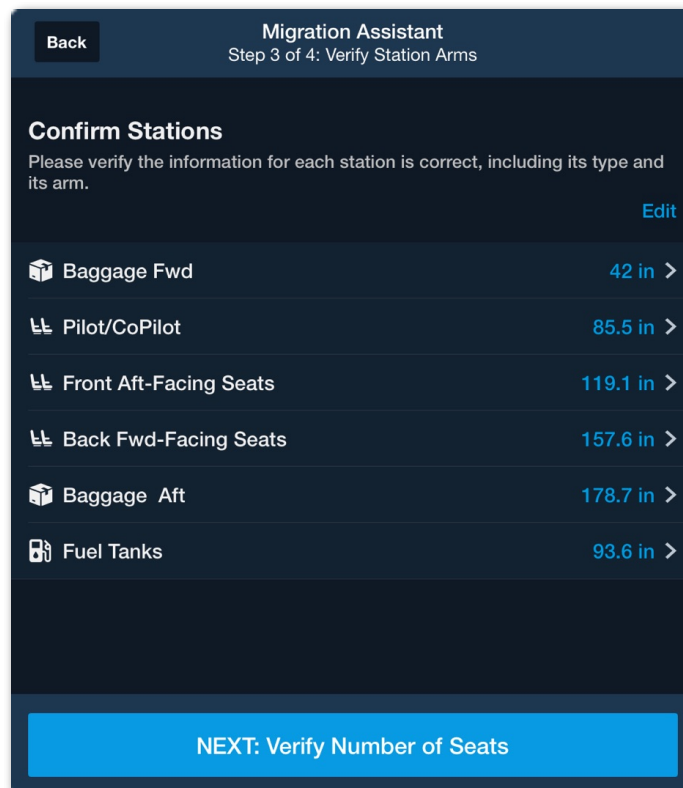

Migration Assistant

3. MIGRATION ASSISTANT

3.1 Migration Assistant Discrepancies

When migrating a legacy profile to the new format, Weight & Balance evaluates the weight limits and aircraft units. If the weight limits or units do not match between the type certificate database and the legacy profile, you must select the correct defaults for the aircraft. If the discrepancies are large, as in the example below, the profile being migrated is not appropriate for the selected aircraft.

The screenshot shows a mobile application interface for the Migration Assistant. At the top, there is a 'Back' button and the title 'Migration Assistant Step 2 of 4: Select Defaults'. Below this is a section titled 'Choose your defaults' with a message: 'Your profile has different weight or length units for the aircraft. Please choose the units you would like to continue with'. There are two radio button options: 'Aircraft defaults' (selected) and 'Profile defaults'. The 'Aircraft defaults' section lists: MTOW: 48,200 lbs, MRW: 48,300 lbs, MZFW: 32,000 lbs, MLDW: 38,000 lbs. The 'Profile defaults' section lists: MTOW: 14,800 lbs, MRW: 15,000 lbs, MZFW: 11,300 lbs, MLDW: 13,500 lbs. Below this is a section for 'AIRCRAFT UNITS' with two rows: 'Weight Units' set to 'Pounds' and 'Length Units' set to 'Millimeters'. At the bottom is a large blue button labeled 'NEXT: Verify Station Arms'.

AIRCRAFT WEIGHT DEFAULTS	
Aircraft defaults MTOW: 48,200 lbs, MRW: 48,300 lbs MZFW: 32,000 lbs, MLDW: 38,000 lbs	<input checked="" type="radio"/>
Profile defaults MTOW: 14,800 lbs, MRW: 15,000 lbs MZFW: 11,300 lbs, MLDW: 13,500 lbs	<input type="radio"/>

AIRCRAFT UNITS	
Weight Units	Pounds
Length Units	Millimeters

NEXT: Verify Station Arms

Migration Assistant Discrepancies

COMPLETED W&B PROFILES

Weight & Balance profiles are accessible from the Aircraft, Weight & Balance, and Flights views (Performance plans only). Profiles can be edited, copied, deleted, and shared.

Profiles sync between devices signed into ForeFlight Mobile. Multi-pilot accounts with *published* aircraft can only configure Weight & Balance for their *published* aircraft using an administrator account and ForeFlight Web.

W&B Profiles

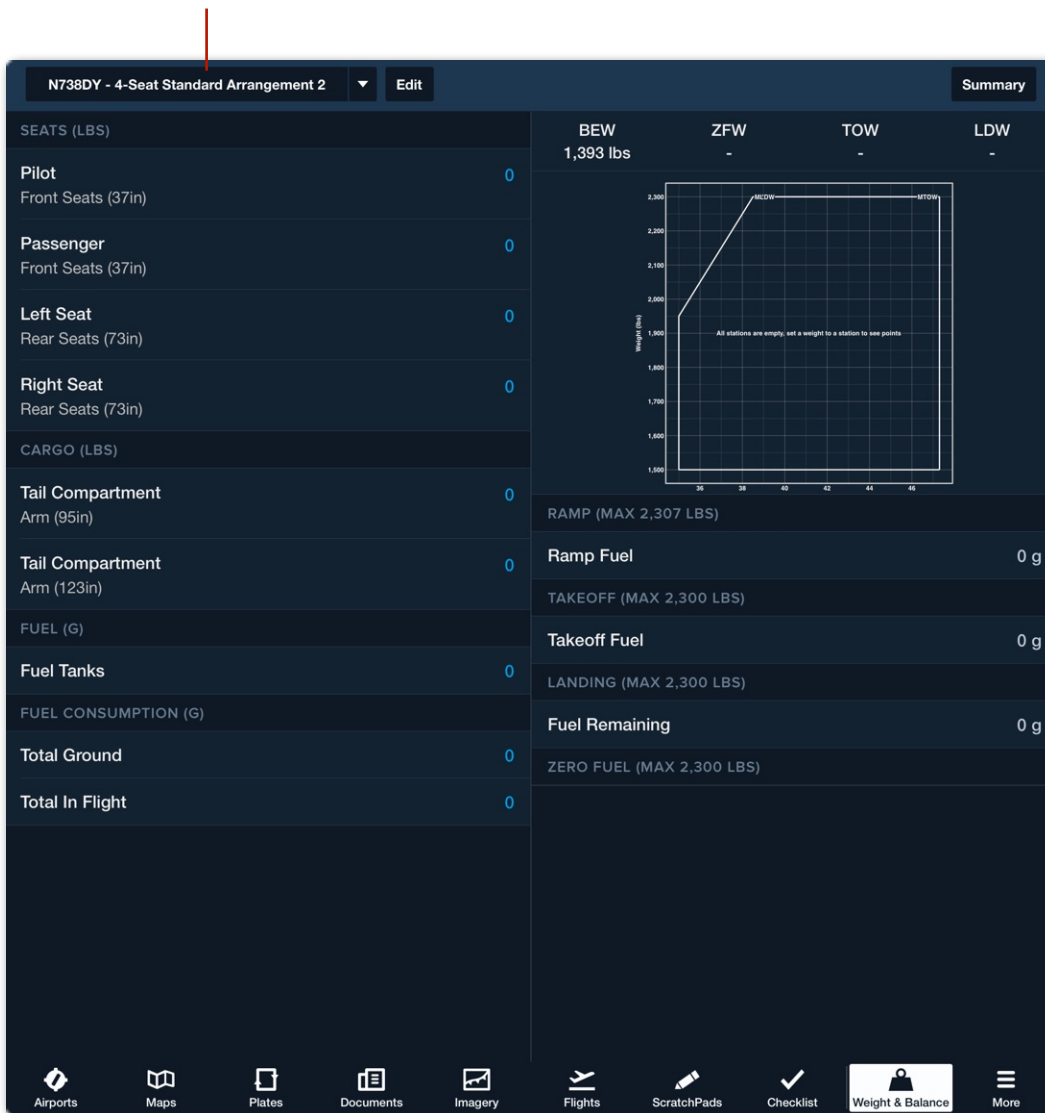

Weight & Balance View

4. COMPLETED PROFILES

4.1 Aircraft with Multiple Weight & Balance Profiles

Aircraft can have multiple W&B profiles. For example, an aircraft with a cargo, passenger, and VIP configuration will require three unique W&B profiles. For many situations, creating a profile, copying the profile and making the appropriate edits for the unique configuration is recommended.

4.2 Copying, Editing, and Deleting Profiles

Copying a profile creates an exact duplicate of the original with the exception of the profile name. Profiles can be copied, edited, and deleted with the Aircraft, Weight & Balance, and Flights views (Performance plans only). Copying and then editing a profile is the recommended process for creating multiple profiles for an aircraft.

4.2.1 Copying, Editing, and Deleting with the Aircraft View

To copy, edit, or delete a W&B profile from the Aircraft view:

1. Select **More** > **Aircraft** and scroll to the Weight and Balance section.
2. Tap an existing W&B profile.
3. Make the appropriate edits or scroll to the bottom of the W&B template.
4. Tap **Copy Profile** or **Delete Profile**.

4.2.2 Copying, Editing, and Deleting with the W&B View

To copy, edit, or delete a W&B profile with the Weight & Balance view:

1. Select **More** > **Weight & Balance**.
2. Select an existing profile from the menu in the upper toolbar.
3. Tap **Edit** in the upper toolbar.
4. Make the appropriate edits or scroll to the bottom of the W&B template.
5. Tap **Copy Profile** or **Delete Profile**.

4. COMPLETED PROFILES

4.2.3 Copying, Editing, and Deleting with the Flights View

Pilots with a Performance-tier plan can copy, edit, and delete W&B profiles from the Flights view. If W&B has not yet been calculated for the flight, follow the steps below.

1. Select the **Flights** view and tap the applicable flight.
2. Tap **Weight & Balance**.
3. Tap **Edit** next to the appropriate W&B profile.
4. Make the appropriate edits or scroll to the bottom of the W&B template.
5. Tap **Copy Profile** or **Delete Profile**.

4. COMPLETED PROFILES

4.3 Sharing Weight & Balance Profiles

Weight & Balance profiles can be shared between ForeFlight accounts using the Aircraft, Weight & Balance, or Flights views (Performance plans only).

If the sender of a Weight & Balance profile makes a change to the profile, those changes are *not* reflected on the recipient's profile. Shared Weight & Balance profiles do not sync between the accounts sharing them.

NOTE: Multi-pilot accounts cannot share the W&B profiles of published aircraft. However, published aircraft profiles can be copied. Then, the W&B profile from the copied aircraft can be shared using the methods discussed below.

4.3.1 Sharing Profiles with the Aircraft View

To share a W&B profile with the Aircraft view:

1. Tap **More > Aircraft**.
2. Scroll to the Weight and Balance section.
3. Tap an existing profile.
4. Tap the **Send To** button in the upper toolbar.
5. Share the profile using one of the standard iOS sharing options.

4.3.2 Sharing Profiles with the Weight & Balance View

To share a W&B profile with the Weight & Balance view:

1. Tap **More > Weight & Balance**.
2. Select the appropriate profile using the menu in the upper toolbar.
3. Tap **Edit** in the upper toolbar.
4. Tap the **Send To** button in the pop-up (see image on next page).
5. Share the profile using one of the standard iOS sharing options.

4. COMPLETED PROFILES

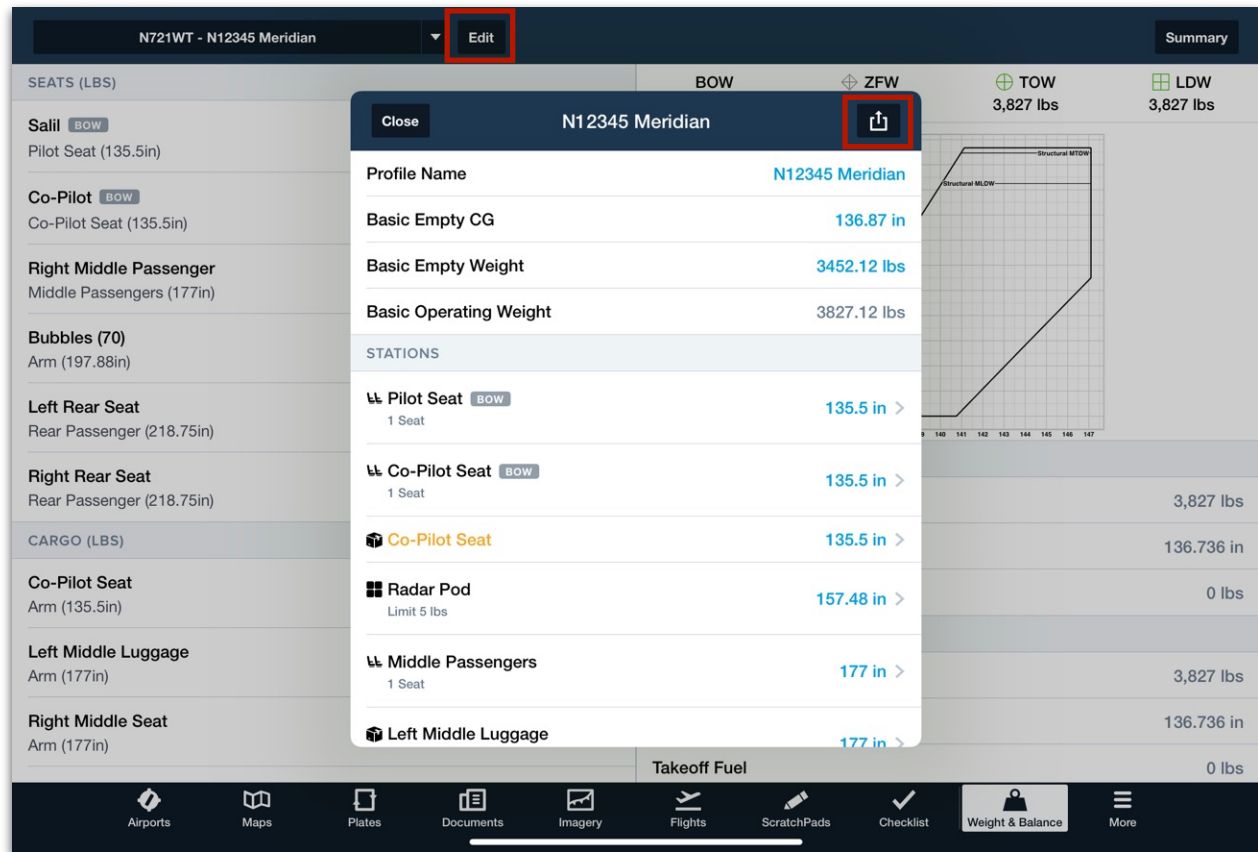

Sharing a W&B profile using the Weight & Balance view

4.3.3 Sharing Profiles with the Flights View

Pilots with a Performance-tier plan can share W&B profiles from the Flights view. If W&B has not yet been calculated for the flight, follow the steps below to share a profile.

1. Select the **Flights** view and tap the applicable flight.
2. Tap **Weight & Balance**.
3. Tap **Edit** next to the appropriate W&B profile.
4. Tap the **Send To** button in the upper toolbar of the pop-up.
5. Share the profile using one of the standard iOS sharing options.

4. COMPLETED PROFILES

4.4 Importing a Shared Profile

To import a shared Weight & Balance profile via email:

1. Open the Mail app on the device importing the profile and select the “Shared W&B Profile” email.
2. Tap the **Click** link to begin importing.
3. ForeFlight automatically opens to the Weight & Balance view after the link is opened.
4. To begin importing the profile, select **Accept** when prompted.
5. Select the aircraft that is associated with the new W&B profile.
6. Verify the profile name, CG, weights, and limits.
7. Tap **Profile Verified & Correct** to complete the import.

View imported Weight & Balance profiles by selecting them from the profile drop-down menu in the Weight & Balance view or by selecting **More > Aircraft** and choosing the aircraft profile associated with the import. There are no indications in ForeFlight that a profile was imported. The Weight & Balance import link can be used multiple times to import copies of the profile. Once a profile has been imported, the Weight & Balance profile can be edited as well as copied.

NOTE: ForeFlight automatically opens to the Weight & Balance view when sharing via AirDrop. If importing via AirDrop, begin at step 4.

4. COMPLETED PROFILES

4.5 Weight & Balance Profile Missing Details

If a profile is missing details, the profile will be **highlighted**. When attempting to calculate Weight & Balance with a profile that's missing details, a pop-up appears with an option to fix the profile.

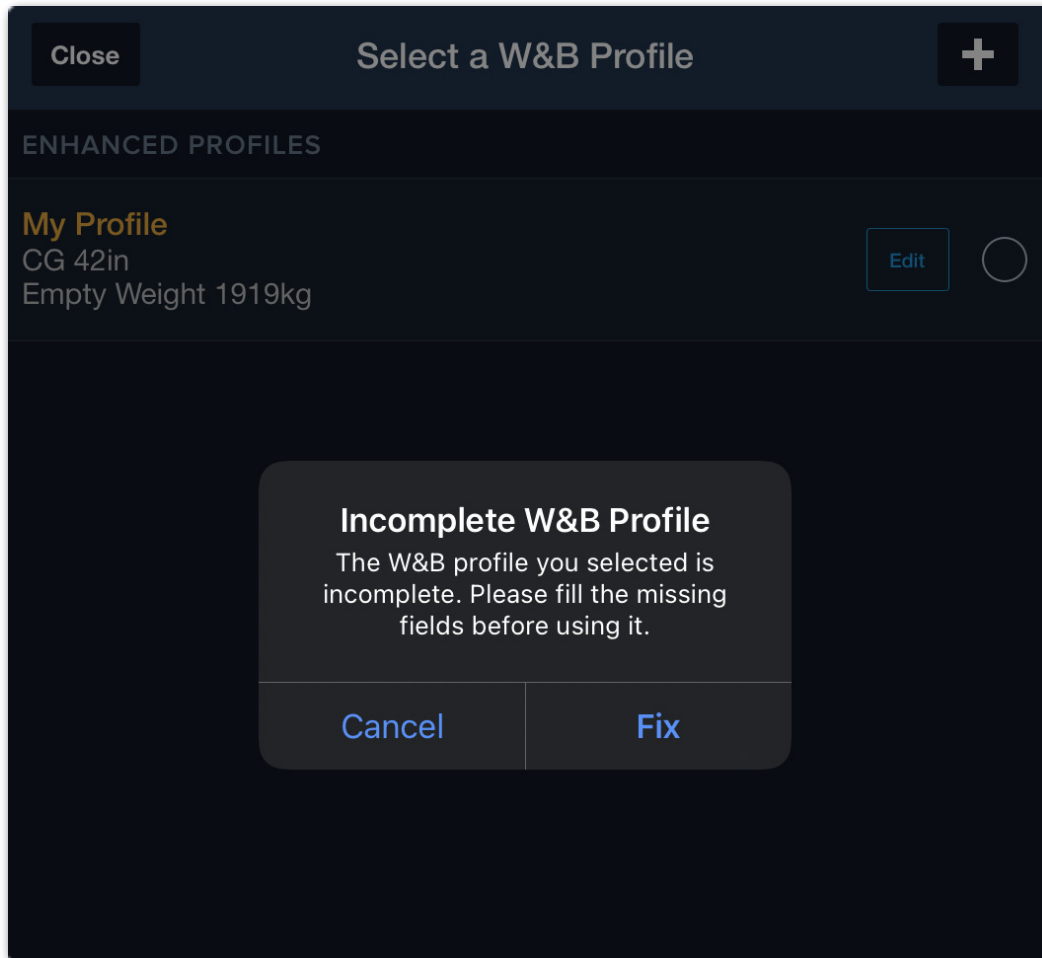

Incomplete Weight & Balance Profile

CALCULATING WEIGHT & BALANCE

W&B can be calculated with the Weight & Balance view. Calculations from the Weight & Balance view are not associated with your planned flights.

Pilots with a Performance-tier account can also calculate W&B using the Flights view. These calculations are integrated with your planned flights and are saved for as long as the flight exists.

ForeFlight Web cannot be used to calculate W&B, however customers with a Dispatch license can calculate W&B using the Dispatch Flight Editor. For more information, see www.foreflight.com/dispatch-guide.

5.1 Calculating Weight & Balance

To calculate W&B using the Weight & Balance view, follow the steps below. To calculate W&B from the Flights view, see [Integrated Weight & Balance](#).

1. Select **More > Weight & Balance**.
2. Tap the profile drop-down menu in the upper toolbar and select a profile.
3. Tap each seat where a person or cargo will be seated and enter a weight and description. Alternatively, select a standard weight or saved load from the menu. See [Seats](#) for more information.
4. Tap the cargo compartment and enter a weight and description. Alternatively, select a saved load from the menu.
5. Tap each aircraft item and enter a weight and description. Alternatively, select a saved load from the menu.
6. Tap the fuel tank and specify the amount of fuel on board the aircraft prior to engine start.
7. Tap fuel consumption and specify the amount of fuel to be used on the ground and in flight. Fuel weight is determined by **Fuel Type** entered in the aircraft profile.

NOTE: Manually entered weights *with* descriptions are automatically added to the **Saved Load** list per station. To remove a saved load from the menu, swipe from right to left on the saved load.

5. CALCULATING WEIGHT & BALANCE

5.1.1 Curtailment Options

Curtailment tools are available to MFB and multi-pilot business accounts. These tools are designed to meet the guidelines and requirements of Advisory Circular 120-27F.

A curtailed envelope is one that is more restrictive than the manufacturer's to account for payload variables. A curtailed envelope sacrifices loading capabilities for ease of use.

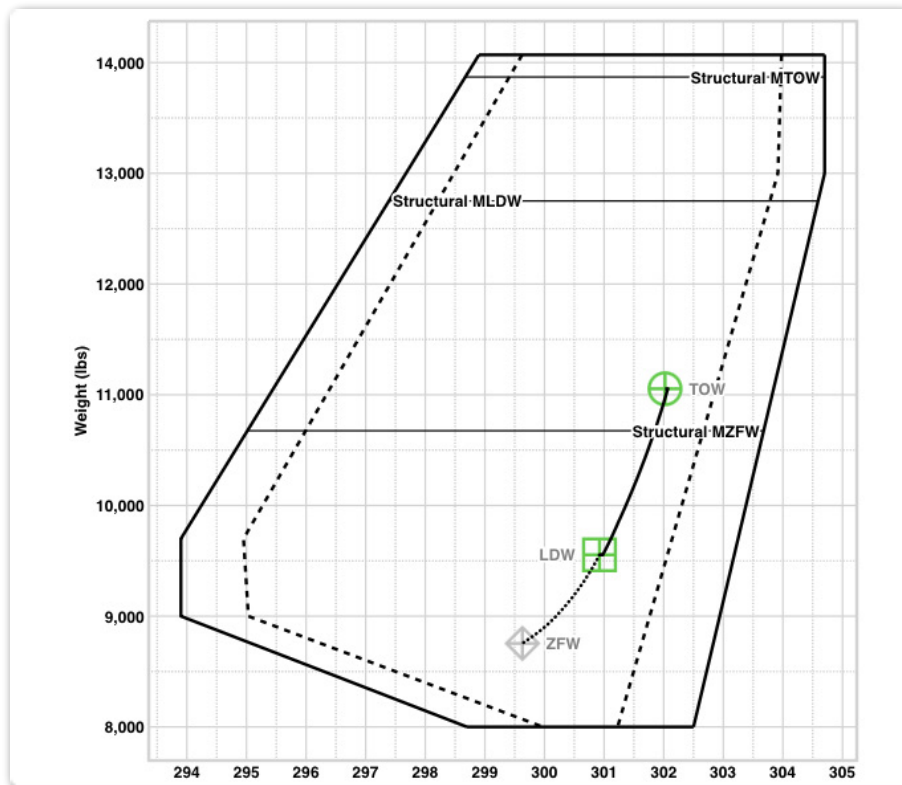

Weight & Balance Curtailed Envelope

WARNING: ForeFlight does not yet support curtailment for in-flight passenger movement, average baggage weight, or passenger seating variations. Standard average passenger weight is the only supported curtailment tool.

5. CALCULATING WEIGHT & BALANCE

5.1.2 Enabling Standard Weight Curtailment

Standard weight curtailment reduces the envelope by a uniform amount based on the aircraft's seating capacity, standard passenger weights, and cabin centroid. See [Calculating the Curtailed Envelope](#) for more information.

To enable curtailed weight and balance, tap the **Standard Weights** toggle switch. When enabled, the curtailed CG envelope is depicted as a dashed line.

NOTE: The **Default Curtailment Option** setting in the weight and balance profile determines if this feature is on or off by default.

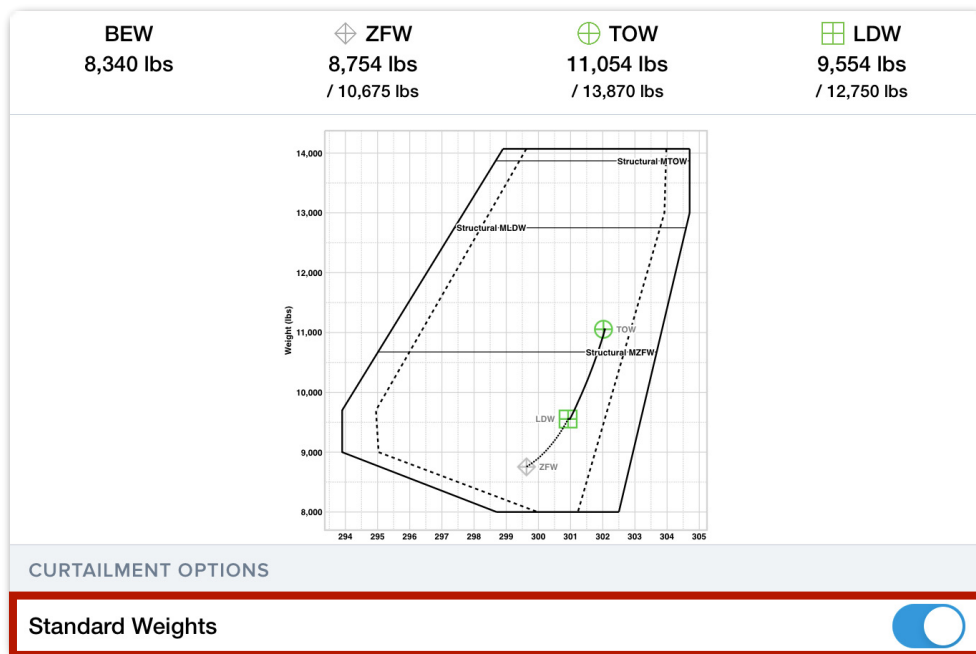

Standard Weights Toggle Switch

The Standard Weights curtailment tool is intended to be used by pilots who know where passengers will be seated and need to calculate a curtailed envelope as they do not have actual passenger weights. If actual passenger weights are used, the Standard Weights toggle should not be enabled.

IMPORTANT: The Standards Weights toggle does not replace passenger weights with standard weights. Nor does it recalculate payload using standard weights. Rather, the toggle only hides or shows the curtailed envelope.

NOTE: Standard weights are defined in **More > Settings > Standard Weights**.

5. CALCULATING WEIGHT & BALANCE

Calculating the Curtailed Operational Envelope

The curtailed envelope is calculated based on the aircraft's seating capacity, standard passenger weights, and cabin centroid. The steps to determine curtailment are defined by Advisory Circular 120-27F and detailed below.

1. To protect against an all-male passenger flight, the difference between the male and average passenger weight is determined (half of the difference between the male average and female average weight).
2. Standard Deviation (defined in **More > Settings > Standard Weights**) is multiplied by the aircraft's row factor (see below).

No. of Rows	2-Abreast	3-Abreast	4-Abreast
2	2.96	2.73	2.63
3	2.41	2.31	2.26
4	2.15	2.09	2.06
5	2.00	1.95	1.93
6	1.89	1.86	1.84
7	1.81	1.79	1.77
8	1.75	1.73	1.69
9	1.70	1.68	1.65
10	1.66	1.65	1.62
11	1.63	1.59	1.59
12	1.60	1.57	1.57
13	1.57	1.54	1.54
14	1.55	1.52	1.52
15	1.53	1.51	1.51
16	1.49	1.49	1.49
17	1.48	1.48	1.48
18	1.46	1.46	1.46

Advisory Circular 120-27F Table D1. Row Factor

3. The values from steps 1 and 2 are added together to determine the weight for curtailment.

For example, the equation below represents an aircraft with 3 rows and 2 seats in each row, a deviation of 47 lbs (default), and the following average weights 200 lbs (male) 160 lbs (female).

$$(2.41)(47) + (200 - 160 \text{ lbs}) \div 2 = 133 \text{ lbs}$$

5. CALCULATING WEIGHT & BALANCE

4. To determine the curtailed weight's moment, the weight (step 3) is multiplied by each seat's arm (e.g., 198 in x 133 lbs = 26334 in lbs).

Row	Seat (arm)	Curtailed Weight	Seat Moment
1	198	133	26334
1	198	133	26334
2	228	133	30324
2	228	133	30324
3	258	133	34314
3	258	133	34314

Determining Curtailed Seat Moment

5. To determine the cumulative affect of curtailed weights, the curtailment weights and seat moments are added (forward to aft) to generate a running total. For example, the first seat in row two is equal to the sum of the first three rows. The total seat moment for that row is also equal to the sum of the first three rows. (26334 + 26334 + 30324 = 82992).

Row	Total Curtailment Weight	Total Seat Moment
1	133	26334
1	266	52668
2	399	82992
2	532	113316
3	665	147630
3	798	181944

Cumulative Curtailment Weight and Seat Moment

5. CALCULATING WEIGHT & BALANCE

6. Step 5 is repeated, in reverse order (aft to forward).

Row	Seat Centroid	Curtailment Weight	Seat Moment	Total (cumulative) Seat Moment
3	258	133	34314	34314
3	258	133	34314	68628
2	228	133	30324	98952
2	228	133	30324	129276
1	198	133	26334	155610
1	198	133	26334	181944

Cumulative Curtailment Weight and Seat Moment

7. The aircraft's cabin centroid is determined by the following steps:

- (i) The number of seats in each row are multiplied by the row location
(2 x 198 in = 396 in).
- (ii) The product of each row is added together
(396 in + 456 in + 516 in = 1,368 in).
- (iii) The number in step 2 is divided by the total number of seats
(1,368 in ÷ 6 seats = 228 inch cabin centroid).

Row No.	No. of Seats	Row Location	No. of Seats x Row Location
1	2	198 in	396 in
2	2	228 in	456 in
3	2	258 in	516 in
TOTAL	6	NA	1,368 in
1,368 in / 6 seats = 228 in			

Determining Cabin Centroid

5. CALCULATING WEIGHT & BALANCE

8. The cabin centroid moment is determined by multiplying the total curtailment weight (step 5) by the cabin centroid (step 7).

Row	Total Weight	Cabin Centroid	Cabin Centroid Moment
1	133	228	30324
1	266	228	60648
2	399	228	90972
2	532	228	121296
3	665	228	151620
3	798	228	181944

Determining Cabin Centroid Moment

9. The differences between the forward-to-aft total seat moment (step 5) and the aft-to-forward total seat moment (step 6) are compared to the Cabin Centroid Moment.

Row	FWD to AFT Total Seat Moment	Cabin Centroid Moment	Deviation	AFT to FWD Total Seat Moment	Cabin Centroid Moment	Deviation
1	26334	30324	-3990	34314	30324	3990
1	52668	60648	-7980	68628	60648	7980
2	82992	90972	-7980	98952	90972	7980
2	113316	121296	-7908	129276	121296	7980
3	147630	151620	-3990	155610	151620	3990
3	181944	181944	0	181944	181944	0

Total Seat Moment Deviation from Cabin Centroid Moment

10. The largest moment deviations from each comparison are identified (7980 in lbs) and are used to calculate the amount of curtailment. The deviation is divided by its corresponding weight to determine how much curtailment to add to the envelope. For example deviation of 7980 in lbs at 10,000 lbs results in a 0.79 inch curtailment.

5. CALCULATING WEIGHT & BALANCE

5.1.2 Special Considerations for Seats

When calculating W&B, seat stations include fields for entering a weight, the type of weight (Person or Other), and a description. Each field is discussed below.

- **Load Weight** is the actual weight of the person or object in the seat.
- **Type** can be either a **Person** or **Other**. If the weight in the seat is an object select Other. If a person is occupying the seat, select Person. The load type specifies if the weight in a seat should be counted as a person. When load type Person is selected, any weight entered in the seat is counted towards people on board. Selecting Other removes the seat weight from the passenger count.
- **Description** serves two purposes:
 1. Adding a description creates a new Saved Load (see next page).
 2. Descriptions differentiate loads from one another and are included in the load summary.

Close Pilot Clear	
Load Weight	190 lbs
Type	Person Other
Description	J Smith
Add a Description to save a load	
STANDARD WEIGHTS	
Male	205 lbs <input type="radio"/>
Female	184 lbs <input type="radio"/>
Child	87 lbs <input type="radio"/>
SAVED LOADS	
Pilot	210 lbs <input type="radio"/>

Example Pilot Seat

5. CALCULATING WEIGHT & BALANCE

Standard Weights

Standard Weights allow for quick entry of people based on predetermined standard weights. To edit standard weights, select **More** > **Settings** > **Standard Weights** (scroll to the bottom of the settings list). Tap a standard weight and edit as necessary. When complete tap outside the menu or tap the **Settings** back button.

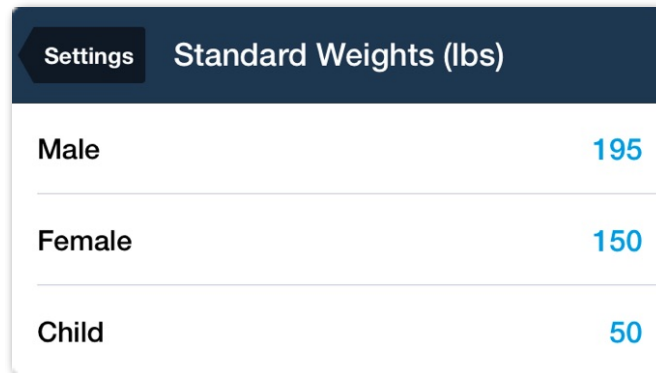

The screenshot shows a mobile application interface for 'Standard Weights (lbs)'. At the top, there is a dark blue header with a 'Settings' button on the left and the title 'Standard Weights (lbs)'. Below the header is a list of three categories: 'Male' with a weight of '195', 'Female' with a weight of '150', and 'Child' with a weight of '50'. Each category is separated by a thin horizontal line.

Category	Weight (lbs)
Male	195
Female	150
Child	50

Standard Weight Settings

Saved Loads

Saved Loads are created anytime a weight with a description is added as a way to quickly enter loads on subsequent flights. Tap a saved load to add it to the station. Delete saved loads by swiping from right to left.

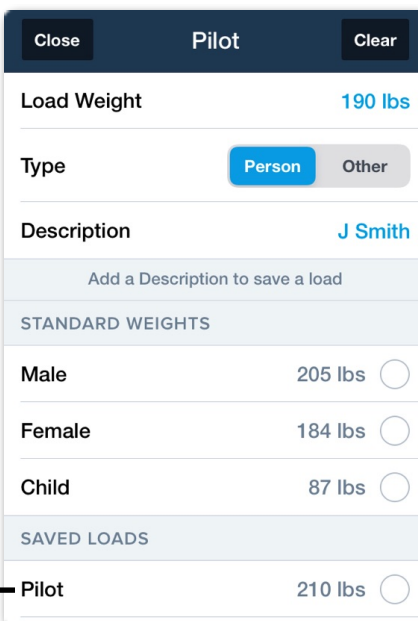

The screenshot shows a mobile application interface for entering a load. At the top, there is a dark blue header with 'Close' on the left, 'Pilot' in the center, and 'Clear' on the right. Below the header, there are several input fields: 'Load Weight' with a value of '190 lbs', 'Type' with 'Person' selected (and 'Other' as an option), and 'Description' with a value of 'J Smith'. Below these fields is a light blue bar with the text 'Add a Description to save a load'. Underneath is a section titled 'STANDARD WEIGHTS' with three rows: 'Male' (205 lbs), 'Female' (184 lbs), and 'Child' (87 lbs), each with a radio button. Below this is a section titled 'SAVED LOADS' with one row: 'Pilot' (210 lbs) with a radio button. A line points from the text 'Saved Load' to the 'Pilot' entry in the 'SAVED LOADS' section.

Category	Weight (lbs)
Male	205 lbs
Female	184 lbs
Child	87 lbs

Category	Weight (lbs)
Pilot	210 lbs

5. CALCULATING WEIGHT & BALANCE

5.2 Weight & Balance Results

Results are dynamically displayed on the right side of the screen. The graph depicts weight and CG limits, takeoff, landing, and zero fuel weights.

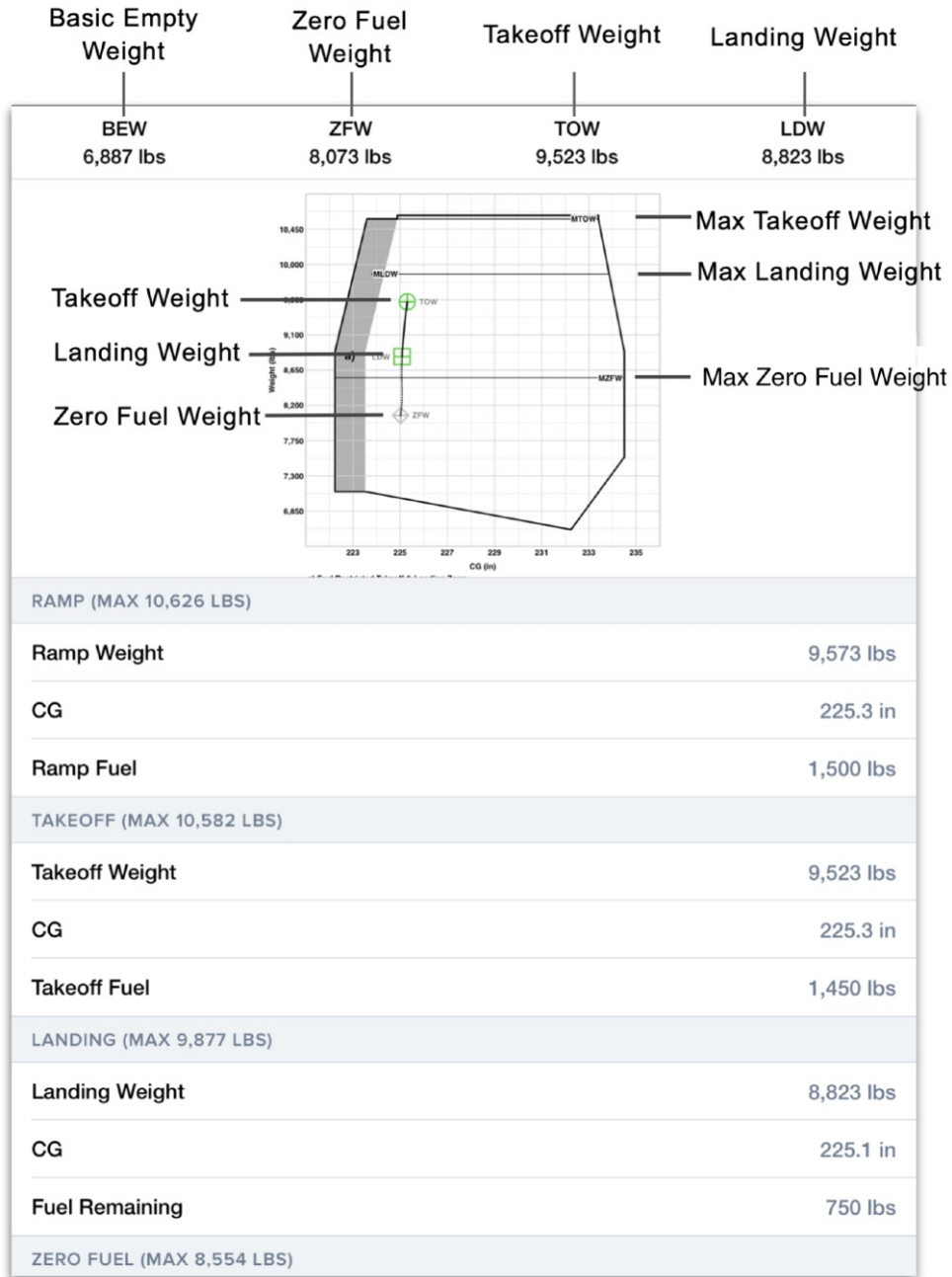

Weight & Balance Results

- ⊕ Takeoff Weight
- ⊞ Landing Weight
- ⊞ Zero Fuel Weight
- ⊕ Max Takeoff Weight Limit Exceeded
- ⊞ Max Landing Weight Exceeded
- ⊞ ZFW Exceeded

5. CALCULATING WEIGHT & BALANCE

5.3 Warnings

If a limitation is exceeded, a warning is depicted near the top of the screen and the graph changes color. If multiple warnings exist, tap the warning label for additional information.

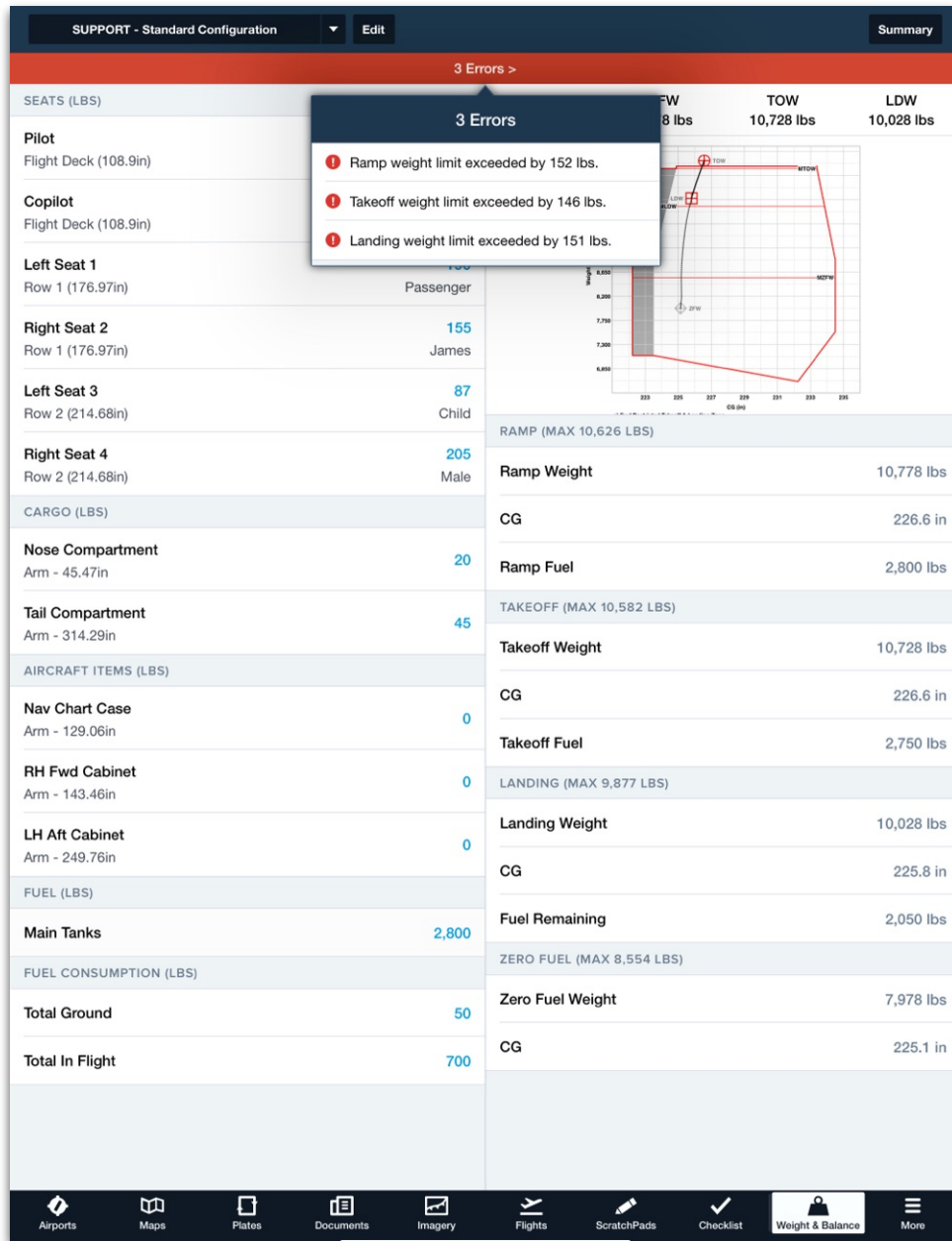

Weight & Balance Warnings

- ⊕ Takeoff Weight
- ⊞ Landing Weight
- ⊠ Zero Fuel Weight
- ⊕ Max Takeoff Weight Limit Exceeded
- ⊞ Max Landing Weight Exceeded
- ⊠ ZFW Exceeded

5. CALCULATING WEIGHT & BALANCE

5.4 Weight & Balance Load Summary

The **Summary** button in the upper toolbar generates a PDF copy of the load summary. To share the PDF, tap the **Send To** button and select an option from the menu. The PDF can be Airdropped, emailed, printed, or saved to an app.

The summary contains a signature, name, and date field. Print and sign the summary or utilize your device's markup tools to sign the W&B digitally.

Summary

Category	BEW	ZFW	TOW	LDW
SEATS (LBS)	6,887 lbs	7,978 lbs	9,428 lbs	8,728 lbs

Summary Table:

Item Description	Weight (lbs)	CG (in)
People		
Flight Deck / Pilot	205	
Male		
Flight Deck / Copilot	184	
Female		
Row 1 / Left Seat 1	190	
Passenger		
Row 1 / Right Seat 2	155	
James		
Row 2 / Left Seat 3	87	9,478 lbs
Child		
Row 2 / Right Seat 4	205	225.4 in
Male		
Cargo		
Nose Compartment	20	1,500 lbs
Tail Compartment	45	
Aircraft Items		
Nav Chart Case	0	
RH Fwd Cabinet	0	9,428 lbs
LH Aft Cabinet	0	

W&B Load Summary Modal:

Load Manifest (Created Oct 27 2021 18:03Z)

Table:

	Weight (lbs)	Limit	CG (in)
Basic Operating Weight	6,887	-	234.5
Payload	1,091	1,667	-
Zero Fuel Weight	7,978	8,554	225.1
Fuel	1,500	2,806	-
Ramp Weight	9,478	10,626	225.4
Taxi Fuel	50	-	-
Takeoff Weight	9,428	10,582	225.4
Fuel To Destination	700	-	-
Landing Weight	8,728	9,877	225.2

CAPTAIN SIGNATURE _____

CAPTAIN NAME _____ DATE _____

Computed using model version number 2.0.

Weight & Balance Load Summary

5. CALCULATING WEIGHT & BALANCE

5.4.1 Signing the Load Summary

It's not possible to sign the load summary from the preview pop-up window. To digitally sign the load summary, either:

Option 1: Share it with an app capable of annotating PDF documents, such as system Files, or

Option 2: To sign the load summary with ForeFlight Document annotation tools, send the load summary to another app, then share it from that app to ForeFlight.

To share the load summary with a third-party app:

1. Tap **Summary** to display the load summary preview.
2. Tap the share button.
3. Select a third-party app from the share menu (Mail, Dropbox, Google Drive, Files, etc).

To sign the load summary with a third-party app:

1. Open the app where you sent the load summary.
2. Sign and date the load manifest within the third-party app.

To share the load summary with ForeFlight:

1. Tap **Summary** to display the load summary preview.
2. Tap the share button.
3. Select a third-party app from the share menu (Mail, Dropbox, Google Drive, Files, etc).
4. Open the app where you sent the load summary.
5. Tap the share button to export the load summary from the third-party app to ForeFlight.
6. When ForeFlight opens, select Documents or Flights to import the load summary (Performance accounts only). Selecting Documents will add the load summary to your Imported Documents Drive. Selecting Flights will provide a prompt to choose a Flight.

To sign the load summary with ForeFlight:

1. Open ForeFlight.
2. Use the annotation tool to sign and date the load summary.

5. CALCULATING WEIGHT & BALANCE

Markup

The share menu includes an option to use Markup to sign and date the load summary. Markup is an iOS built-in PDF editor. If you sign and date the load summary with Markup, you are using the iOS built-in PDF editor and not ForeFlight.

After signing the load summary with Markup, it is not possible to send the load summary directly back to ForeFlight. Load summaries signed with Markup can be sent to third-party apps for saving and then imported back to ForeFlight if desired.

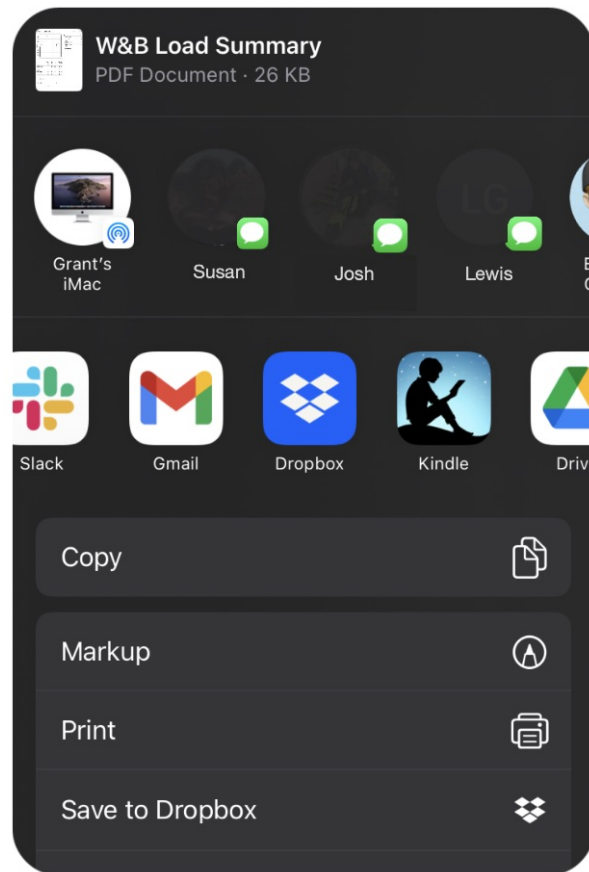

Share Menu with Option to Markup

5. CALCULATING WEIGHT & BALANCE

5.5 Integrated Weight & Balance

Integrated Weight & Balance simplifies the flight planning process by *copying* payload and fuel information from the Flights view to the Weight & Balance. Calculations are retained with the flight and can be referenced as long as the flight is not deleted. To calculate W&B, the **Weight and Balance** button must be tapped.

KCXO to KAUS
Mon Feb 28, 1:30pm CST

Distance	ETE	ETA (CST)	Flight Fuel	Wind
118 nm	1h03m	2:33 pm	16 g	13 kts head

PAYLOAD (LBS)

	COUNT	AVG WT.	TOTAL
People	3	200	600
Cargo			0
Total Payload			600

Weight and Balance

FUEL	LBS	GAL
Fuel Policy	Minimum Fuel Required >	
Start	146	25
63 gal available	MAX / 528	/ 88

Tap to calculate Integrated Weight & Balance

NOTE: When adding passengers and crew using People Count, they are loaded in the aircraft from front to back. ForeFlight does not currently consider the aircraft's CG when copying people from Flights to Weight & Balance.

5. CALCULATING WEIGHT & BALANCE

To calculate *Integrated Weight & Balance*

1. Plan a flight with the Flights view.
2. Enter people and cargo information in the Payload section.
3. Verify the fuel load or select a fuel policy.
4. Tap **Weight and Balance**.
5. Select the desired W&B profile from the menu.
6. Verify seat, cargo, and aircraft items. Edit as necessary.
7. Verify fuel weight. Edit as necessary.

NOTE: Edits made on the **Weight and Balance** view are copied to the flight. Pilots may elect to bypass entering payload information on the Flights view in favor of entering it after tapping **Weight and Balance**.

The screenshot displays the 'Flights' view in the ForeFlight app. At the top, it shows the flight route 'KCXO to KAUS' for 'Mon Feb 28, 1:30pm CST'. Key flight metrics are listed: Distance 138 nm, ETE 1h09m, ETA (CST) 2:38 pm, Flight Fuel 17 g, and Wind 8 kts head. Below this, a list of flight plans is shown, with the selected flight 'KCXO to KAUS (IFR)' highlighted. The flight details for this plan include: 6,000' MSL in N9370X, ETA 2:38 PM CST ETE 1h09m, and IDU1 IDU CWK. The 'Payload (LBS)' section is expanded, showing a table with columns for 'COUNT', 'AVG WT.', and 'TOTAL'. The table lists 3 people (200 lbs each, total 600 lbs) and 45 lbs of cargo, resulting in a 'Total Payload' of 645 lbs. A green box highlights the 'Weight and Balance' button at the bottom of the payload section. The bottom navigation bar includes icons for Airports, Maps, Plates, Documents, Imagery, Flights, ScratchPads, Checklist, Logbook, and More.

	COUNT	AVG WT.	TOTAL
People	3	200	600
Cargo			45
Total Payload			645

Integrated Weight & Balance

5. CALCULATING WEIGHT & BALANCE

5.5.1 Integrated Weight & Balance Results

Integrated Weight & Balance results are dynamically updated as you enter payload and fuel details. The fields do *not* lock and can be edited at any time. Changes made on the Weight & Balance view are reflected on the Flights view and vice versa. After verifying flight details, tap the Back button in the upper toolbar to return to the main flights view.

The **Weight and Balance** button is replaced with a label to indicate if the aircraft's W&B is loaded within limits. Tap the Weight & Balance label to review or edit the flight's W&B.

PAYLOAD (LBS)			
	COUNT	AVG WT.	TOTAL
▶ People	2	205	410
▶ Cargo			59
▶ Aircraft Items			600
Total Payload			1,069
Weight & Balance			In Balance >
Remove Weight and Balance			

PAYLOAD (LBS)			
	COUNT	AVG WT.	TOTAL
▶ People	2	205	410
▶ Cargo			59
▶ Aircraft Items			6,000
Total Payload			6,469
Weight & Balance			Out of Balance >
Remove Weight and Balance			

In Balance and Out of Balance Integrated W&B Labels

5.5.2 Removing Integrated Weight & Balance

Integrated Weight & Balance calculations are associated with the flight as long as the flight is not deleted. Once a flight is deleted, its W&B calculations are also deleted.

To remove a W&B without deleting a flight, tap the **Remove Weight and Balance** button at the bottom of the Flights Payload section.

PAYLOAD (LBS)			
	COUNT	AVG WT.	TOTAL
▶ People	2	205	410
▶ Cargo			59
▶ Aircraft Items			6,000
Total Payload			6,469
Weight & Balance			Out of Balance >
Remove Weight and Balance			

Remove Weight and Balance Button

5. CALCULATING WEIGHT & BALANCE

5.6 Ballast Fuel

Ballast fuel is unusable, extra fuel that is added to the aircraft's zero fuel weight to move the aircraft's center of gravity within limits. The following aircraft models support Ballast Fuel with a Performance-tier account:

- Cessna 650 Citation III
- Cessna 650 Citation VI
- Cessna 650 Citation VII
- Cessna 750 Citation X
- Cessna 750 Citation X+

5.6.1 Adding Ballast Fuel

Ballast Fuel is added when calculating W&B from the Weight & Balance or Flights view. If an aircraft's center of gravity exceeds the aft limits and Ballast Fuel can improve the aircraft's CG, a **USE** button is displayed next to the Ballast Fuel with an amount of fuel to resolve the error.

When Weight & Balance is complete, Ballast Fuel is included at the bottom of the Flight's Fuel section, the Navlog, and the Weight & Balance Summary Document.

PAYLOAD (LBS)	
Weight & Balance	In Balance >
Remove Weight and Balance	
FUEL	
Fuel Policy	Minimum Fuel Required >
▼ Total Start 2,709 lbs available	<input type="button" value="MAX"/> 708 / 1,109 4,776 / 7,485
Fuselage Tank	148 1,000
Wing Tanks	560 3,776
▼ Flight Fuel	360 2,428
Taxi Fuel	30 200
Fuel to Destination	330 2,228
▼ Fuel at Landing	349 2,347
Alternate Fuel	0 0
Reserve Fuel	169 1,138
Extra Fuel	0 0
Ballast Fuel Wing Tanks	180 1,209
WEIGHTS (LBS)	

Ballast Fuel

Flights Planning Form

LEGACY WEIGHT & BALANCE

ForeFlight Mobile version 14.2 (March 2022) included the addition of Enhanced Weight & Balance. Profiles created prior to this version of Weight & Balance are *Legacy* profiles.

Legacy profiles can be updated to take advantage of the enhancements using **Migration Assistant**. If your device is unable to update to ForeFlight version 14.2 or you prefer Legacy Weight & Balance, refer to this chapter for additional information.

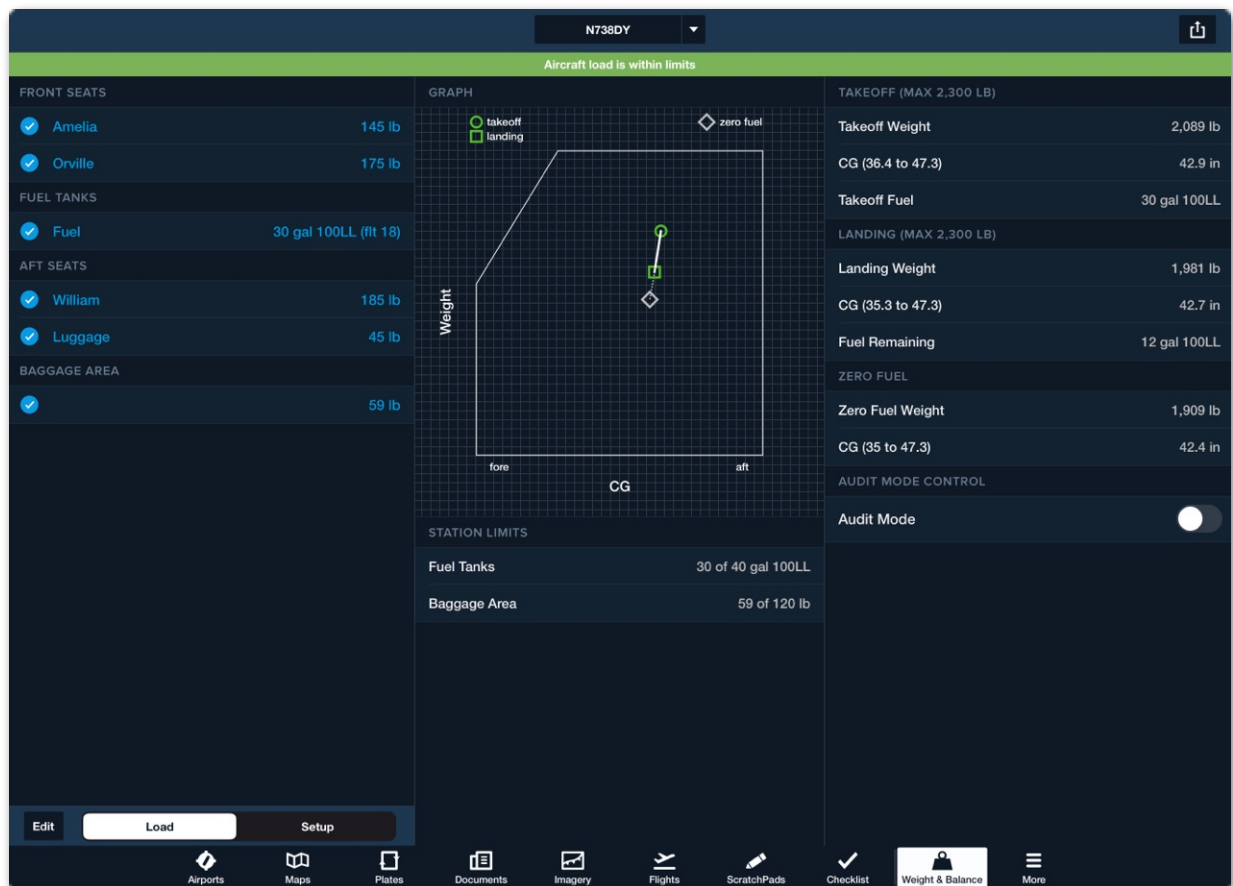

Legacy Weight & Balance

6. LEGACY WEIGHT & BALANCE

Legacy Weight & Balance can be used for fixed-wing aircraft that meet these requirements:

- Constant weight limits (i.e., do not vary with CG)
- Takeoff and Landing CG limit envelopes are the same
- Only one fuel moment table (i.e., a single variable-arm fuel station)

Weight & Balance profiles are created using the SmartOptions™ interview process. The interview searches Type Certificates to quickly set up your aircraft's profile based on its tail number, empty weight, empty CG, and moment from the POH. The SmartOptions interview is available for many popular Cessna, Cirrus, Diamond, Mooney, and Piper aircraft.

If an aircraft's Weight & balance profile is not found in the SmartOptions database, a profile can be manually created by completing the manual profile interview. Legacy Weight & Balance lacks the following features:

- Legacy W&B profiles are not associated with aircraft profiles.
- Legacy W&B is not integrated into flights.
- Legacy W&B does not support station type.
- Legacy W&B does not support aircraft with multiple fuel moment tables.

6. LEGACY WEIGHT & BALANCE

6.1 Creating Profiles

To create a Legacy Weight & Balance profile

1. Select **More > Weight & Balance**.
2. Tap the **[+]** button or select **Add New Profile** from the drop-down in the upper toolbar.
3. Enter the your aircraft's tail number.
4. Tap **Next**.

If the tail number is found in the FAA type certificate database and a Weight & Balance profile exists for the aircraft, the SmartOptions interview questions will begin.

If the tail number is not found in the type certificate database or if a profile does not exist for the aircraft type, tap **OK** and proceed with the manual profile interview steps.

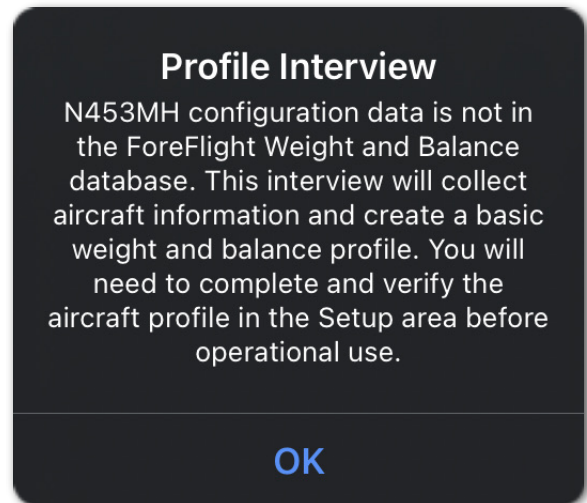

Profile Not Found

6.1.1 SmartOptions Interview

When a profile is found for your aircraft, station and limit details are automatically entered. To complete the SmartOptions interview:

1. Select the appropriate aircraft configuration.
2. Enter the aircraft's basic empty weight.
3. Enter the aircraft's basic empty CG.
4. Tap **Next**.

6. LEGACY WEIGHT & BALANCE

6.1.2 Manual Interview

If a profile does not exist for your aircraft, it is necessary to enter all information using the manual process. To create a profile using the manual process:

1. Choose the aircraft's unit of length.
2. Choose the aircraft's weight unit.
3. Choose the unit of measure that your aircraft uses to calculate fuel burn.
4. Choose the aircraft fuel type.
5. Select the types of stations your aircraft has.
6. Enter the aircraft's basic empty weight.
7. Enter the aircraft's basic empty CG.
8. Tap **Save**

Step 5 Cancel Step 6 Next

CHOOSE STATIONS FOR N453MH

Cockpit	<input checked="" type="checkbox"/>
Front Seats	<input checked="" type="checkbox"/>
Need More Seat Choices ... adds more seat choices in a later step	<input type="checkbox"/>
Baggage Area	<input checked="" type="checkbox"/>
Need More Baggage Choices ... adds more baggage choices in a later step	<input type="checkbox"/>
Fuel Tanks	<input checked="" type="checkbox"/>
Need More Fuel Choices ... adds more fuel choices in a later step	<input type="checkbox"/>
Built-in Oxygen Tank	<input type="checkbox"/>
De-ice Fluid Tank	<input type="checkbox"/>

Manual Interview

6. LEGACY WEIGHT & BALANCE

6.1.3 Completing a Manual Profile

After completing the interview questions, you must enter station arms, limits, weight limits, and CG limits. To complete the profile, select **Setup** (near the bottom of the screen) and enter the required information.

STATIONS		GRAPH	TAKEOFF	
Cockpit	Arm Not Set		Takeoff Weight	2,100 lb
Front Seats	Arm Not Set	CG	24 in	
Baggage Area	Arm Not Set	Takeoff Fuel	0 lb	
Fuel Tanks	Arm Not Set	LANDING		
EMPTY AIRCRAFT		Landing Weight	2,100 lb	
Weight	2,100 lb	CG	24 in	
CG	24 in	Fuel Remaining	0 lb	
Moment	50,400 in-lb	ZERO FUEL		
WEIGHT LIMITS		Zero Fuel Weight	2,100 lb	
Ramp	None	CG	24 in	
Takeoff	None	AUDIT MODE CONTROL		
Landing	None	Audit Mode <input type="checkbox"/>		
Zero Fuel	None			
FORWARD CG LIMITS				
0 in	0 lb			
0 in	0 lb			
AFT CG LIMITS				
0 in	0 lb			
0 in	0 lb			

NOTICES

- ⚠ The takeoff weight limit is not set.
- ⚠ A station arm is not set.
- ⚠ Each forward CG limit point should have a unique weight.
- ⚠ Each aft CG limit point should have a unique weight.

Buttons: Edit, Load, Setup

Incomplete Setup

6. LEGACY WEIGHT & BALANCE

Limits

Tap an entry in the Weight Limits section to display the pop-up. Enter the relevant weights for your aircraft, then tap **Save**. If a particular limit is not specified in your POH, leave it blank.



Weight Limits

NOTE: Zero fuel is the maximum weight limit for the aircraft with zero fuel onboard. This limit is uncommon for general aviation aircraft.

6. LEGACY WEIGHT & BALANCE

Stations

Stations include items that can change weight with each flight.

- Crew and Passenger (Seats)
- Fuel
- Cargo
- Aircraft Items

Refer to the Weight & balance section of your flight manual for station information. The distance a station is from the reference datum is its arm.

Tap each station (selected during the manual interview) and enter a name, arm, and weight limit for the station (if applicable). Ensure the station type is correct before tapping **Save**. If additional stations are necessary, tap **Edit** (near the bottom of the screen) and select **Add New Station**.

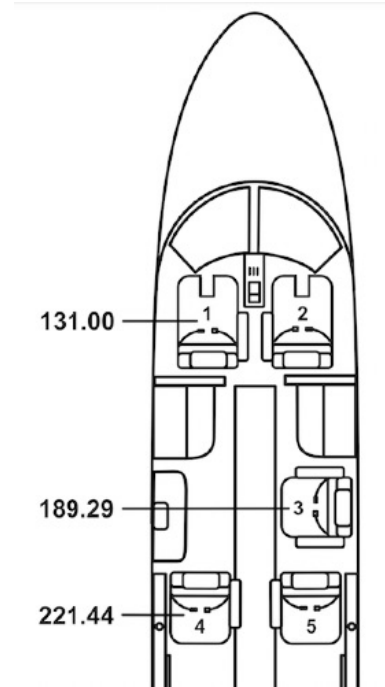

Example Stations

Seats that are in the same row and have the same arm only need to be added once as a station. Multiple seats in a row are added later in the **Load** view.

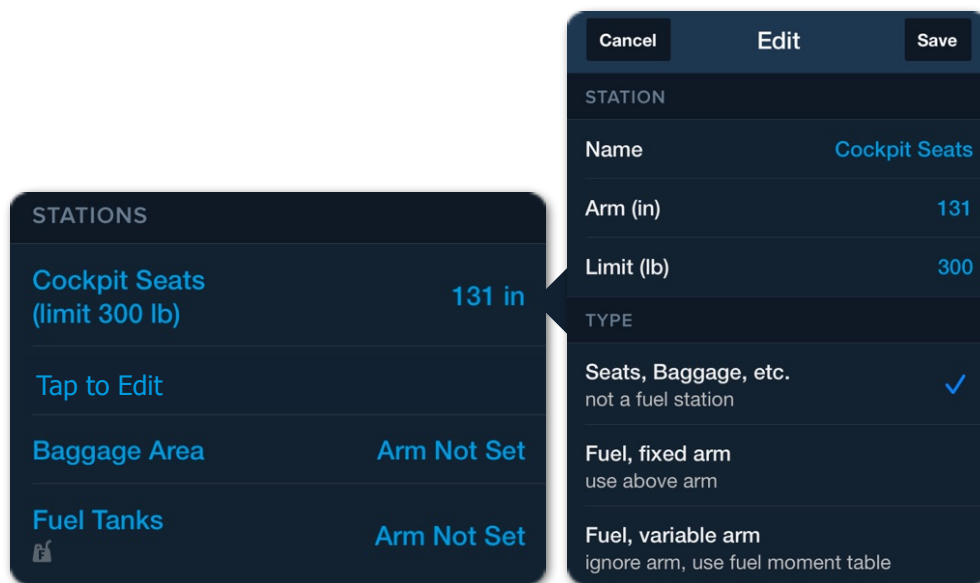

Cockpit Seat Arm 131.00

6. LEGACY WEIGHT & BALANCE

Stations (Fuel)

Many general aviation aircraft have fuel tanks with fixed arms. To add this type of station:

1. Tap the fuel tank station.
2. Enter the fuel tank's name, arm, and limit in the pop-up.
3. Select **Fuel, fixed arm**.
4. Tap **Save**.

Cancel
Edit
Save

STATION

Name Fuel Tanks

Arm (in) 95

Limit (lb) 288

Limit (gal 100LL) 48

TYPE

Seats, Baggage, etc.
not a fuel station

Fuel, fixed arm ✓
use above arm

Fuel, variable arm
ignore arm, use fuel moment table

Fuel - Fixed Arm

	Weight (Lbs)	Arm Aft Datum (Inches)	Moment (In-Lbs)
Licensed Empty Weight			
Oil (8 quarts)	15	24.5	368
Pilot and Front Passenger	340	80.5	27370
Passengers, Aft (Rear Seat)	340	118.1	40154
Fuel (48 Gal. Maximum)		95.0	
*Baggage		142.8	
Moment due to Retracting of Landing Gear			819
Total Loaded Airplane			

Sample Stations

6. LEGACY WEIGHT & BALANCE

Stations (Fuel - Variable Arm)

If your aircraft's fuel tank does not burn fuel symmetrically, it has a variable fuel arm. Aircraft with variable fuel arms have fuel moment tables. Fuel moment tables depict the fuel's moment based on a specific weight. To enter this type of station:

1. Tap the fuel station and select **Fuel, Variable Arm**.
2. Tap **Save**.
3. Scroll to the bottom and locate the Fuel Moment Table section.
4. Tap **Edit**.
5. Tap **Add New Fuel Moment**.
6. Enter a fuel Weight & corresponding moment.
7. Repeat steps 5-6 until all rows are entered.

Entering fuel weights and moments in the order they appear is recommended. Fuel moment table rows can be rearranged by selecting **Edit** and dragging the rows up or down. Verify that the fuel moment table units are correct (inch-pounds). If the moment is divided by an amount (MOMENT/100), remove the division by multiplying the moment by the same amount before entering it into the ForeFlight Fuel Moment Table.

WEIGHT (POUNDS)	MOMENT/100 (INCH-POUNDS)
100	311.72
200	619.45
300	923.80
400	1226.16
500	1527.43
600	1828.57
700	2130.74
800	2433.92
900	2737.96
1000	3042.77
1100	3348.26
1200	3654.36
1300	3961.04
1400	4268.25
1500	4575.96
1600	4884.49
1700	5193.78
1800	5503.69
1900	5814.20
2000	6125.28
2100	6436.95
2200	6749.18
2300	7061.97
2400	7375.33
2500	7689.28
2600	8003.82
2700	8318.98
2800	8634.75
2900	8951.12
3000	9268.10

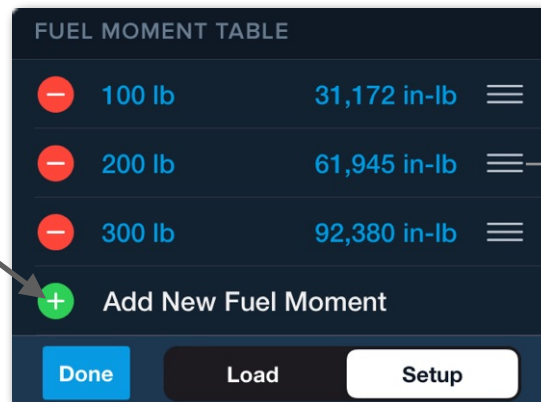

Drag to rearrange

Fuel Moment Table

6. LEGACY WEIGHT & BALANCE

CG Limits

The final step in completing a manual profile is the aircraft's CG envelope. CG limits are often in the Limitation section of a flight manual or are depicted in a graph in the Weight & balance section. If using the graph, identify the points (bends) where the limits change direction. You will need to enter a CG arm and its corresponding weight limit for each point. To add CG limits:

1. Tap the Forward CG or AFT limit and enter a Weight & arm.
2. Tap **Edit > Add New Forward (or AFT) Point**
3. Enter the next CG limit and corresponding arm, tap **Save**.
4. Repeat steps 2-3 until all points (bends) which define the forward and AFT CG points are entered.

The maximum gross weight for the aircraft must be entered as a CG limit. In this example, the max gross weight of the aircraft is 2400 lbs. Ensure your graph depicts the CG envelope as weight over arm. If the CG graph uses weight over moment, convert the moment to arm by dividing it by the corresponding weight.

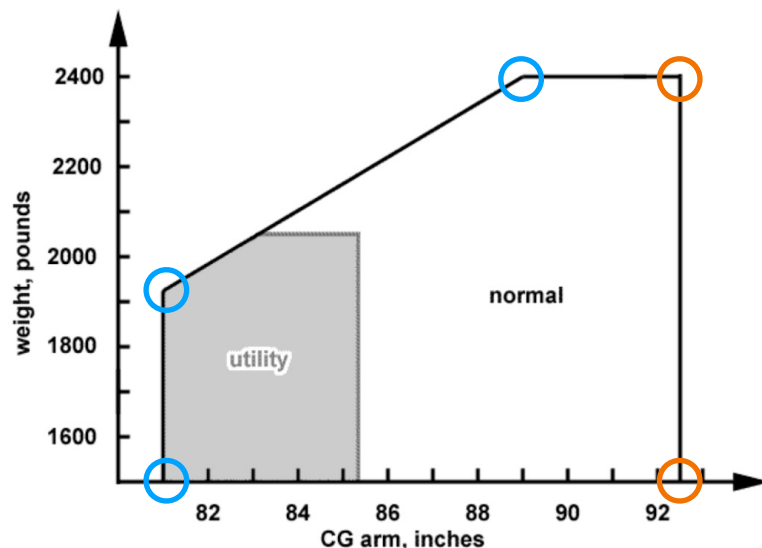

FORWARD CG LIMITS	
99 in	2,400 lb
81 in	1,920 lb
81 in	1,500 lb

Forward CG Limits

AFT CG LIMITS	
92.3 in	2,400 lb
92.3 in	1,500 lb

AFT CG Limits

6. LEGACY WEIGHT & BALANCE

Common Mistakes

If your chart looks to be approximately the correct shape but is squished or offset, this is usually caused by entering numbers directly out of a POH, which divides the moment by 100 or 1000.

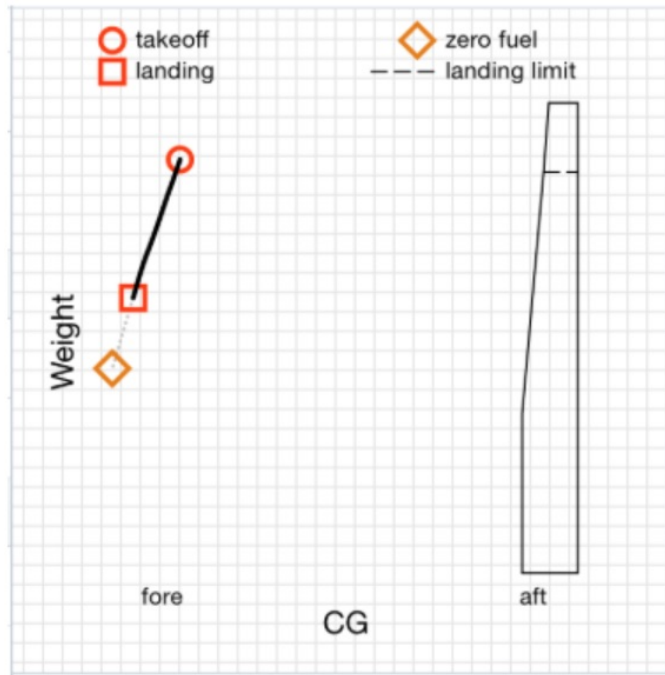

Error due to using divided moment values

Correct this by making sure you've entered the moment in inch-lbs, which will require multiplying the POH numbers by 100 or 1000 before entering them into the CG Arms and Limits section.

6. LEGACY WEIGHT & BALANCE

Top of the CG Arm and Limits graph is offset

If the top of your CG Arm and Limits Graph is offset, you have entered a Takeoff or Ramp weight limit lower than the maximum weight entered in the Moments. Correct this by changing the Takeoff or Ramp weight limit(s) or the Moments.

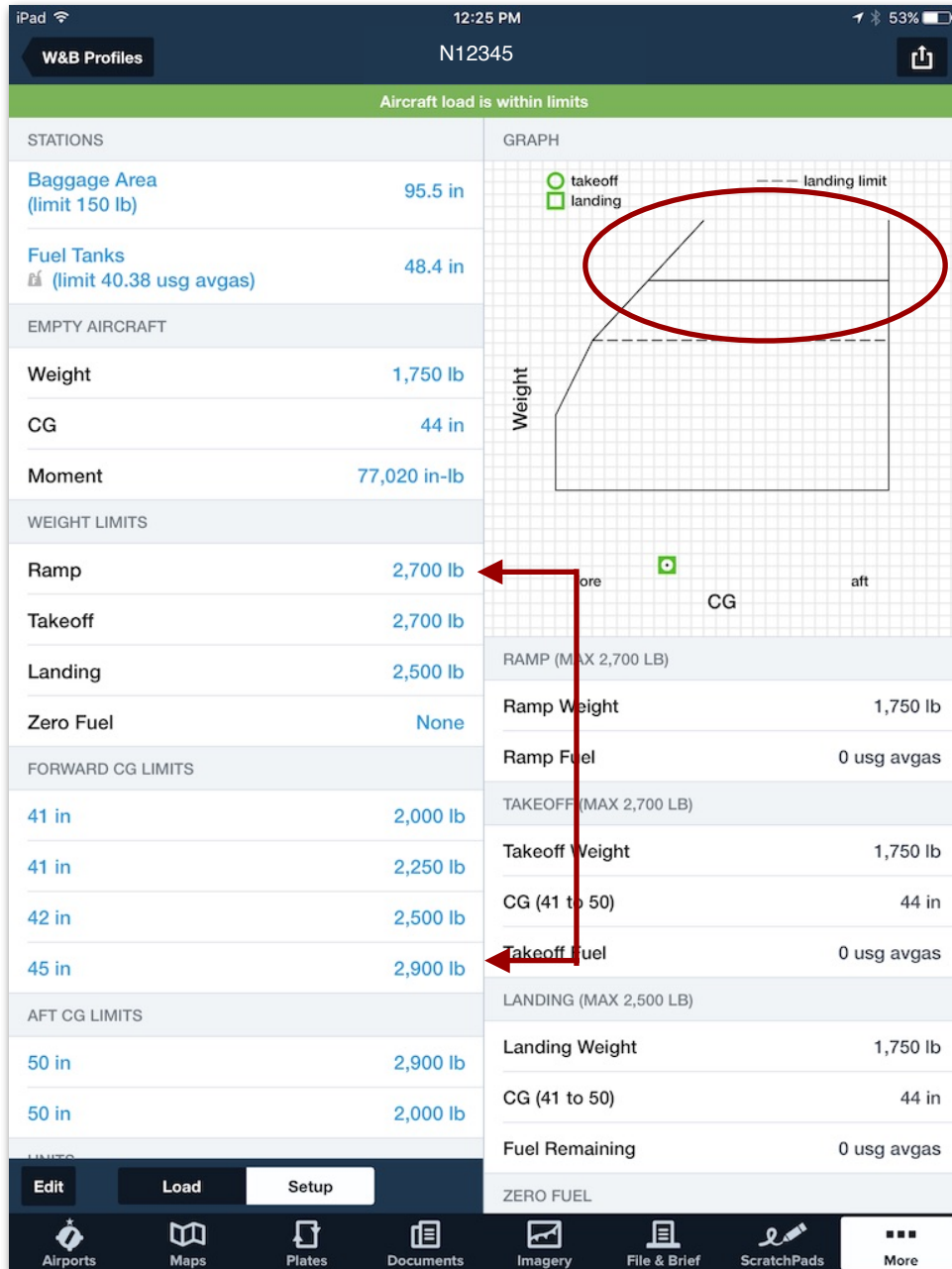

CG limits exceed Ramp or Takeoff limits

6. LEGACY WEIGHT & BALANCE

6.2 Complete Profiles

After creating a profile, it is selectable from the drop-down menu in the upper toolbar. Select the completed profile and review it for accuracy. If a profile needs to be edited, tap **Setup** near the bottom of the screen and edit the fields as necessary. To add or delete stations, CG limits, or Fuel Moment Table rows, tap **Edit > Delete** or **Add New Station**. Weight & Balance fields can also be deleted by swiping from right to left.



Editing a Completed Profile

6. LEGACY WEIGHT & BALANCE

6.3 Calculating Weight & Balance

To calculate Weight & balance before a flight, select the appropriate profile from the menu in the upper toolbar and select **Load** at the bottom of the screen. On the Load page, tap each station to enter a Weight & name. Tap **Save** when you have completed the entry. When entering the fuel load, be sure to enter the amount of fuel planned for in-flight and ground use.



Calculating Weight & Balance

6. LEGACY WEIGHT & BALANCE

6.3.1 Saved Loads

To add additional loads to a station (row), select **Edit** > **Add New Load**. Enter a name and weight for the load and tap **Save**. When complete, tap **Done** near the bottom of the profile. Stations can have an unlimited number of loads. If you regularly fly with the same crew, passengers, fuel, or cargo, we recommend adding them as saved loads.

Selected Load

Saved Load (Not selected)

Cargo Station

Station	Item	Weight
FRONT SEATS	Amelia	145 lb
	Orville	175 lb
FUEL TANKS	2 Hours	30 gal 100LL (flt 18)
	Top Off	42 gal 100LL (flt 33, grd 2)
AFT SEATS	William	185 lb
	Luggage	45 lb
	Jim	205 lb
CARGO	Suitcase	40 lb
	Camera	25 lb
	Emergency Kit	30 lb

GRAPH

Weight vs CG (fore to aft)

takeoff, landing, zero fuel

RAMP (MAX 2,310 LB)

Ramp Weight	2,248 lb
Ramp Fuel	30 gal 100LL

TAKEOFF (MAX 2,300 LB)

Takeoff Weight	2,248 lb
CG (38 to 47.3)	44.2 in
Takeoff Fuel	30 gal 100LL

LANDING (MAX 2,300 LB)

Landing Weight	2,140 lb
CG (36.9 to 47.3)	44 in
Fuel Remaining	12 gal 100LL

ZERO FUEL

Selecting Loads

Crew, passengers, cargo, and fuel are only included in your Weight & balance calculations if the checkmark next to the load is selected. By adding all of the loads you typically fly with, you can quickly calculate Weight & balance by selecting the appropriate loads.

6. LEGACY WEIGHT & BALANCE

Rearranging Loads

If you need to move a load from one station to another, tap Edit and drag the load to the new station. When the loads have been moved to the new station, tap Done.

6.4 Copying a Profile

Once you have created a profile, you can copy it if needed. This is helpful if you fly multiple aircraft of the same type.

To copy a profile, tap the share button in the upper toolbar and select Copy. Enter a name for the profile and select Save.

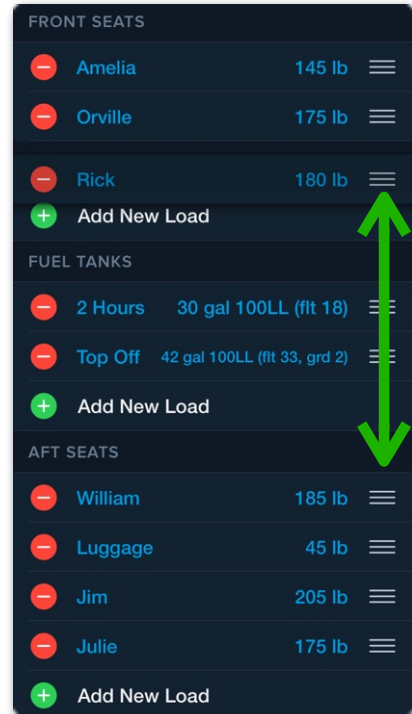

Rearranging Loads

6.5 Sharing a Profile

To share a profile with another pilot, tap the share button in the upper toolbar and select Mail. The receiving device can import the profile by opening the email using Apple Mail and tapping the profile name link. Tapping the LoadingSummary.PDF attachment opens the PDF copy of the Weight & balance but does not import the profile.

Import

A weight and balance profile has been sent to you from ForeFlight Mobile. If you already have ForeFlight Mobile installed on your iOS device, add this profile now:

[N738DY](#)

If you do not already have ForeFlight you can get it here: [App Store](#).

Also included in this mail is a file containing a loading summary for archival or documentation purposes.

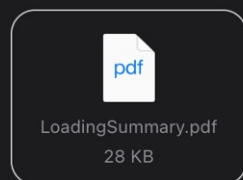

6. LEGACY WEIGHT & BALANCE

6.6 Deleting a Profile

To delete a profile, open the list of profiles by tapping the drop-down menu in the upper toolbar. Select Edit, then tap the red circle next to the profile you want to delete. Lastly, select the Delete confirmation button. You can also swipe from right to left across a profile to delete it.

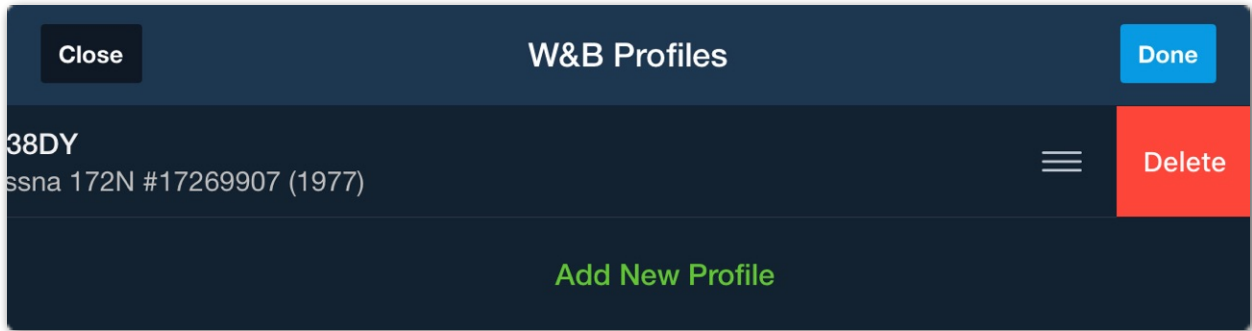

Deleting a Weight & Balance Profile

CHANGE HISTORY

Version	Date	Change Summary
15.4	April 2023	<ul style="list-style-type: none"> • Curtailment options added. • Miscellaneous styling and content updates.
15.3	March 2023	<ul style="list-style-type: none"> • Ballast fuel added. • Gear retraction moment change added. • Miscellaneous styling and content updates.
14.5	June 2022	<ul style="list-style-type: none"> • Added fuel density information.
14.4	May 2022	<ul style="list-style-type: none"> • Added information related to seat station types. • Added information related to signing the load summary. • Added fuel sequencing information. • Added W&B profile sharing.
14.2	March 2022	<ul style="list-style-type: none"> • Added Enhanced Weight & Balance. • Added Dispatch Weight & Balance. • Added Legacy Weight & Balance.
14.0	February 2022	<ul style="list-style-type: none"> • Revision to organization and formatting.
9.2	July 2017	<ul style="list-style-type: none"> • Updated style for consistency with other guides.
7.5	December 2015	<ul style="list-style-type: none"> • Minor updates
7.4	November 2015	<ul style="list-style-type: none"> • Added “Empty CG” field to interview process and to Setup page.
6.3	August 2014	<ul style="list-style-type: none"> • Added Weight & Balance, which includes the SmartOptions™ interview to quickly add aircraft details based on Type Certificate data.



ForeFlight

A Boeing Company

ForeFlight, LLC
2323 S Shepherd Dr, Houston, TX 77019
www.foreflight.com